

Mixed 2D and 3D Survey Plans with Topological Encoding

Thompson, Rodney James; van Oosterom, P.J.M.; Soon, Kean Huat

Publication date

2016

Document Version

Final published version

Published in

Proceedings of the 5th International FIG Workshop on 3D Cadastres

Citation (APA)

Thompson, R. J., van Oosterom, P. J. M., & Soon, K. H. (2016). Mixed 2D and 3D Survey Plans with Topological Encoding. In P. J. M. van Oosterom, E. Dimopoulou, & E. M. Fendel (Eds.), *Proceedings of the 5th International FIG Workshop on 3D Cadastres* (pp. 133-152). International Federation of Surveyors (FIG).

Important note

To cite this publication, please use the final published version (if applicable).
Please check the document version above.

Copyright

Other than for strictly personal use, it is not permitted to download, forward or distribute the text or part of it, without the consent of the author(s) and/or copyright holder(s), unless the work is under an open content license such as Creative Commons.

Takedown policy

Please contact us and provide details if you believe this document breaches copyrights.
We will remove access to the work immediately and investigate your claim.

Mixed 2D and 3D Survey Plans with Topological Encoding

Rodney James THOMPSON, Australia, Peter van OOSTEROM, the Netherlands and
Kean Huat SOON, Singapore

Key words: 3D Spatial Unit, LADM, Topological Encoding

SUMMARY

There is a wide range of spatial units in jurisdictions around the world, ranging from simple 2D parcels (spatial units defining 3D column of space) to complex 3D collections of spaces, which are defined at various levels of sophistication from textural descriptions to complete, rigorous mathematical descriptions based on measurements and coordinates. The principal spatial unit to be considered in a cadastral database is the base 2D land parcel - the basic spatial unit of land that is subject to ownership or other rights by a party. There is a varying complexity of 3D subdivision of the base 2D land parcels, and a complex set of secondary interests (other RRRs), which may refer to all or part of a base cadastral 2D land parcel, or span several 2D land parcels. 3D spatial units may be defined entirely by reference to the structure which houses them (the “building format units”), or volumetrically by the dimensions of boundary surfaces. 2D land parcels (implying 3D columns of space) or 3D spatial units may also be subdivided into smaller spatial units, with the remainder being kept as common property for the owners of the individual units. This has led to the adoption of multi-level schemes. In this paper, we explore the practicality of encoding spatial units in a way that highlights their 2D extent (as typically represented on maps, survey plans and existing cadastral databases), while fully defining their extent in the third dimension. The suggested method uses a form of mixed-dimensional topological encoding (sharing boundary definitions between adjoining spatial units) that is simple and efficient in space requirements. It prevents problems of overlapping between spatial units in 3D, while providing a data source for a mixed 2D / 3D digital cadastral database without redundancy or inconsistency. The topology is limited to the survey plans (and not whole cadastral database), but these should include all relevant boundaries: new, deleted and changed ones. The value of topology is high as in the survey plans there can be many neighbouring spatial units; especially in case of 3D buildings where (nearly) all units are adjacent or on top of each other and there are many shared boundaries and units commonly share the same footprint. Specifically the paper discusses the expressions of topological encoding for the purposes of survey plan representations, including the questions of curved surfaces, (partly) unbounded spatial units, grouping and division of 2D and 3D spatial units (‘hierarchy’). It is suggested that the conceptual model behind this encoding approach can be extend to the cadastral database schema itself, including the requirement to maintain a historical record of the spatial unit structure (lineage).

Mixed 2D and 3D Survey Plans with Topological Encoding

Rodney James THOMPSON, Australia, Peter van OOSTEROM, the Netherlands and
Kean Huat SOON, Singapore

1. INTRODUCTION

In many jurisdictions the cadastral survey plan is a critical instrument in the administration of property rights, being the starting point that defines the extent and location of the property. The secondary purpose of such a (digital) plan is as a data source for a database (and map) of cadastral information. With the growing trend towards digital submission of cadastral plans, there is a need to maintain the authoritative nature of the plan in the absence of a paper document. It is critical that the definitions of properties are correct and topologically sound, with adjoining properties identified in 2D and 3D. Despite the fact the term ‘Survey Plan’ is used, in reality it may not always involve a survey. Especially in case of 3D spaces, a 3D survey might be either impossible (e.g. subsurface or airspace parcels) or less practical (e.g. rather reuse 3D geometry from CAD/ BIM models for legal spaces related to buildings and constructions). Survey is still relevant to check spaces after construction according to CAD models, or to provide 2D surface ‘footprint’ references for 3D subsurface or airspaces.

There is a wide range of spatial units in jurisdictions around the world, ranging from simple 2D parcels (spatial units defining 3D column of space) to complex 3D collections of spaces, which are defined at various levels of sophistication from textural descriptions to complete, rigorous mathematical descriptions based on measurements and coordinates. Moreover, these ranges co-exist within the same jurisdiction (Kaufman and Steudler 1998). The principal spatial unit to be considered in a cadastral database is the base 2D land parcel - the basic unit of land that is subject to ownership or other rights by a party. In its simplest form, it is defined as a simple “ring” of boundary lines in 2D and describes a prism of space running from below the earth’s surface to a level well above, i.e. a 3D column of space.

Moving out from this simple 2D land parcel, larger regions are defined - administrative areas, which may be comprised of a large number of parcels, but can also be partially or completely defined by natural features of the land - for example, a drainage basin defined by ridge lines. This is relevant for both 2D and 3D representation. In the other dimension, there is a varying complexity of 3D subdivision of the base 2D land parcels, and a complex set of secondary interests (other RRRs), which may refer to all or part of a base cadastral 2D land parcel, or span several 2D land parcels. 3D spatial units may be defined entirely by reference to the structure which houses them (“building format units”), or volumetrically by the dimensions of boundary surfaces. There are also hybrid spatial units which are partially defined by building walls, floors, ceilings etc.; and partly by measurements (e.g. car parking bays).

A further challenge is in the definition of “common” (or shared) property. 2D land parcels (3D columns of space) or 3D spatial units may be subdivided into smaller spatial units, with the remainder being kept as common property for the owners of the individual units. For example town houses within a 2D land parcel (spatial unit), with the driveways and gardens being held for common use, or a 3D building with both private spaces and common use

spaces for the elevators, foyer etc.. This has led to the adoption of multi-level schemes, with base 2D land parcels (3D columns of space) being subdivided into volumetric spatial units; which are in turn further subdivided into individual units. Another example, a building may be placed on a base parcel, leaving property in common. It can be subdivided into volumetric spatial units for different classes of units (commercial, residential, etc.), leaving common property for entrance, elevators, etc. The volumetric spatial units can then be subdivided into individual units, with common property for the use of these unit owners (but not for owners of units in other volumes). It should be noted that when a volumetric unit is excised from a 2D parcel, the common property left will be partially unbounded: to the bottom, to the top, and possibly to the sides.

The Land Administration Domain Model (LADM) provides for all of these levels of complexity (Lemmen 2012, ISO-TC211 2012), and it has been shown by (Thompson et al, 2016) that a mixed representation allows a relatively simple encoding of the full range of cadastral spatial units. The latter paper, however does not address the issue of topological encoding of such a mixture of spatial units. The issues involved in encoding a survey plan (as distinct from a cadastral database) include some extra complexity. If the survey plan is to be the official and authoritative definition of a set of spatial units, to be used as the basis for recording interests (RRRs), it must be definitive. That is to say, it must carry the legal definition of the parcel. As such, it is unacceptable to represent a curve or curved surface by a polygonal approximation in a digital plan.

This paper explores the practicality of topologically encoding spatial units in a way that highlights their 2D extent (as typically represented on maps, survey plans and existing cadastral databases), while fully defining their extent in the third dimension. The suggested method uses a form of mixed-dimensional topological encoding (sharing boundary definitions between spatial units) that is simple and efficient in space requirements. It prevents problems of accidental overlap between spatial units in 3D, while providing a data source for a mixed 2D / 3D digital cadastral database without redundancy or inconsistency.

This paper discusses the expressions of topological encoding for the purposes of survey plan representations, including the questions of curved surfaces, (partly) unbounded spatial units, grouping and division of 2D and 3D spatial units ('hierarchy'). It is suggested that this approach can be extended to the cadastral database itself, including the requirement to maintain a historical record of the spatial unit structure (lineage).

In what follows, Section 2 discusses the concept of survey plans and the research on topology for cadastral data. Section 3 outlines the basic principles of encoding for 2D and 3D spatial units with topology. Section 4 demonstrates the complexity of such encoding in a real use case and Section 5 shows the representation in LandXML. Finally, Section 6 concludes the paper with summarizing the main results and indicating future work.

2. BACKGROUND

This section first elaborates the purpose and role of the survey plans in the context of land administration. Next, the importance of topology in a cadastral database is reviewed.

2.1 Survey plans

Typically, cadastral jurisdictions separate the administration of land “Rights Responsibilities and Restrictions” (RRR) into the action of defining the piece of land on a “Survey Plan” and the RRR and parties involved on a Title document (as in the case of the Torrens Titling System) or Deed document. Despite the fact that the term ‘Survey Plan’ is used, in reality it may not always involve a survey in the conventional sense. Many types of technology are used, particularly where 3D spatial units are involved (e.g. laser scanner), to produce a combination of sketches, tabular data and measurements that serve the purposes to which a survey plan are put.

As an instrument to determine land interests, the survey plan becomes a legal document that defines the exact extents of the interest in question. This requires that it carries strong and valid metadata such as who, when, how and under what authority it was made. It must be unambiguous and definitive, and becomes the ultimate authority defining the extent and location of the interest. New or changed spatial units on survey plan should not intrude the neighbouring unchanged spatial units. The requirement to be definitive, for example means that if a spatial unit has curved surfaces in its boundary, the plan must carry that as a definition. It is not acceptable to approximate curves with straight lines and planar facets. It may be acceptable for a sketch on the plan to be produced by faceting, but the plan must contain the intelligence that the boundary is curved, with the definition of that curvature.

When the time comes for a property to be redefined (by subdivision for example), a new plan of survey may be required. The surveyor who is tasked with the re-survey will make use of all existing surveys in the area to locate, confirm and re-instate the existing spatial unit before beginning the process of redefinition. Thus all historic plans of survey must be available on request to support this action. Further, there must be features, monuments, permanent marks, measurements, etc. recorded on the plan to assist the surveyor in a definitive identification. Although a prospective buyer of a spatial unit may elect to have it re-surveyed for identification purposes, it is still important that a non-technical person is able to understand a plan. If assured that any encroachments, secondary interests or other important issues are identified, and the spatial unit is identified in relation to other properties and landmarks, and is properly dimensioned, the owner or potential buyer knows exactly what they are dealing with.

The essential information carried on a survey plan is typically collected into a database to provide a multiple use cadastral database. Uses for this include: an index to the properties to give an overview of land subdivision; a background map for other assets such as street furniture; visualisation of 3D subdivisions; and many more.

Traditionally, a survey plan was a paper document, which was reassuring in that it carried seals and signatures, and was suitable for long term archive and storage. However in this

form, it was clumsy as a data source, especially when the preparation of these paper documents started to be a computer process. Recently there has been an effort to switch to digital plans, containing, in structured and semantically enriched manner, the spatial and measurement data. This has not changed the fundamental requirements of the survey plan as noted above. In addition, the move to 3D spatial units has led to a much greater complexity of the plans - needing to carry elevation diagram and/or isometric views to make the geometry comprehensible. In Singapore, New Zealand and Australia, the LandXML format (LandXML 2016) has been chosen to transport digital plans.

2.2 Topology in cadastral data

The 2D spatial unit has a special place in a cadastre. Often there is an identifiable “base layer” of 2D spatial units (implying 3D prisms) which comprises a complete, non-overlapping coverage of the jurisdiction. With the scarcity and value of land in modern cities, there is a strong trend to subdivision into explicit 3D spatial units. Typically, a 3D spatial unit which is to be associated via RRR with a party (person etc.) will be a closed volume, with a complete and well defined boundary (shell), but each time a closed volume is defined within a 2D spatial unit, it leaves a 3D “object” (a prism with a cavity). There is no volume to be determined for such a remainder spatial unit as it has an undefined top and bottom.

Alternatively, 3D spatial units may be defined, not by measurements but by the references to walls and floors/ceilings in a building that encloses them. There may be sketches on the plan of their location within the building, but the sketch is not the definition of the extents of the spatial unit (and may not have any measurements marked). In Queensland and Singapore, these do not have volumes defined, but are defined to have a certain floor area.

There has been considerable discussion on the subject of topological encoding of cadastral data in 2D over the years (van Oosterom et al 2002, Hoel et al 2003, Louwsma 2003). One major advantage of the topological approach is the reduction in redundant storage of linework. There are different types of topology - from the simple single layer complete non-overlapping coverage, to the multi-layer with topological connections maintained between levels. In practice, a cadastral database needs to accommodate multiple levels of data - ranging from the simple property spatial unit, aggregated into administrative regions, and subdivided into 3D spatial units and into secondary interests (such as easements).

Figure 1 gives a rough schematic of the sub and super-sets of a basic spatial unit. Administrative areas may not consist of an integral number of whole spatial units, and secondary interests may span more than one base spatial unit.

It has been shown (de Hoop et al 1993) such partial hierarchies can be accommodated in 2D, with the decision to use a number of single valued vector map (SVVM) layers, or alternatively more tightly as a multi valued vector map (MVVM). Similarly, such SVVM or MVVM's could be defined in 3D. This is a question of balancing consistency against complexity. Integrating multiple levels in a MVVM enables the reuse of boundaries needed at two or more levels (good for consistency), but also causes some geometry fragmentation in other cases.

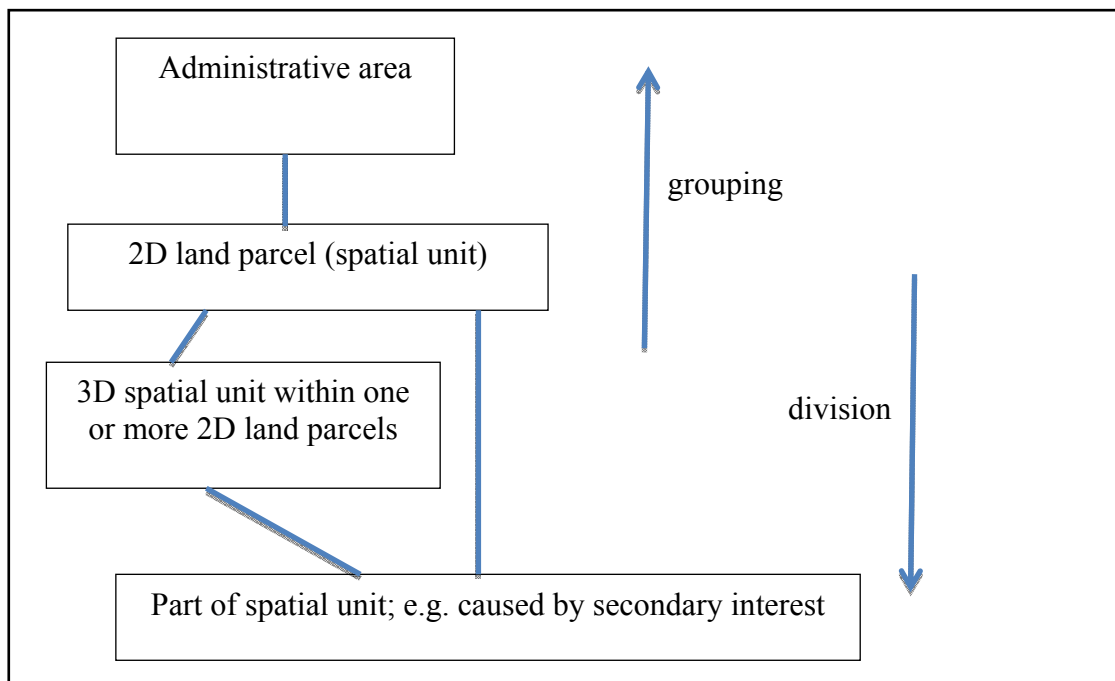

Figure 1. A rough "hierarchy" of spatial units

The question of extending the principle of topological encoding to 3D has been covered in detail, and in several ways, but always with the aim of a true 3D coverage - where all objects are volumetric (Ledoux et al 2007, Boguslawski et al 2009). By contrast, it has been shown that the vast majority of 3D cadastral parcels are relatively simple (Thompson et al 2015), and savings can be made by using that fact (Thompson et al 2016).

3. TOPOLOGICAL ENCODING FOR 2D AND 3D SPATIAL UNITS

In this section the topological encodings for the following three representations are presented: 2D Cadastral Spatial Units, Simple 3D Spatial Units, and Complex 3D Spatial Units.

3.1 2D cadastral spatial units

2D topology can be encoded by representing cadastral boundaries as line strings, with encoding for the “left” and “right” base cadastral units. For example, a “winged edge” structure (Baumgart 1972) can be extended to include non-base spatial units by including additional left/right encodings for non-base 2D spatial units (administrative areas, secondary interests, easements etc). This is the approach taken to develop a 2D topologically encoded multi-layer Cadastral database such as the Netherlands Kadaster with left and right references at multiple-levels: parcel, cadastral section, and municipalities (Van Oosterom 2000).

For a mixed 2D/3D cadastral database, the 1D linestrings in 2D space that are used to define the cadastral boundaries are re-interpreted as 2D face strings in 3D space (as defined in the LADM) (Lemmen et al 2010). This does not change the database representation at all, adding nothing to the storage requirements because the storage of a LA_BoundaryFaceString is simply as a 1D linestring in 2D space.

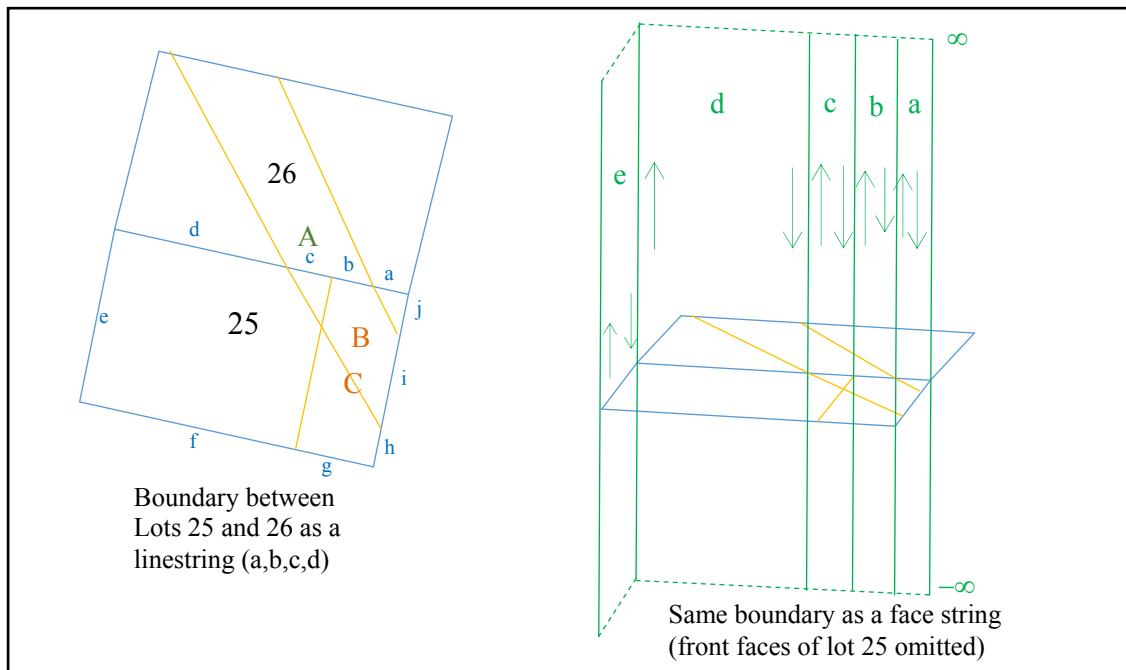

Figure 2. Interpreting a line string topological boundary as a LA_BoundaryFaceString

To illustrate this, let us consider Figure 2 as an example of a multi-valued-vector-map style encoding. In Figure 2:

- i. Line segment *a* has Lot 25 and Easement C on **left**; Lot 26 on **right**;
 - ii. Line segment *b* has Lot 25, Easement B and C on **left**; Lot 26 and Easement A on **right**;
 - iii. Line segment *c* has Lot 25 and Easement B on **left**; Lot 26 and Easement A on **right**;
 - iv. Line segment *d* has Lot 25 on **left**, Lot 26 on **right**;
 - v. Line segment *e* has Lot 25 on **left**;
- (therefore, Lot 25 is defined as being on the left of Line segments *a,b,c,d,e,f,g,h,i,j*).

The 2D spatial units are “converted” into 3D spatial units by replacing each line segment in their boundary by a face running from $-\infty$ to $+\infty$, and passing through the endpoints. The inside of any face is that side from which it appears to be clockwise, so that the same definitions apply, with the words “on left” replaced by “inside”, and “on right” with “outside”.

3.2 Simple 3D spatial units

The simplest of the 3D spatial units are those bounded by planar surfaces - the “Polygonal Slice” and the “Above/Below Elevation” (Thompson et al 2015) spatial units (see Figure 3 for example). These are delimited above and/or below by surfaces - usually horizontal. Only slightly more complex, are the volumes bounded by vertical faces, and with a well-defined top and bottom surface, which are not per se exactly horizontal (therefore the triangulation of these surface in the example of Figure 3). In either of these cases, the storage mechanism is to define the face strings as above - delimiting the footprint of the spatial unit, and the top and bottom as surfaces defined by one or more polygonal faces (curved faces will be discussed later). These faces may be shared with adjoining spatial units in 3D.

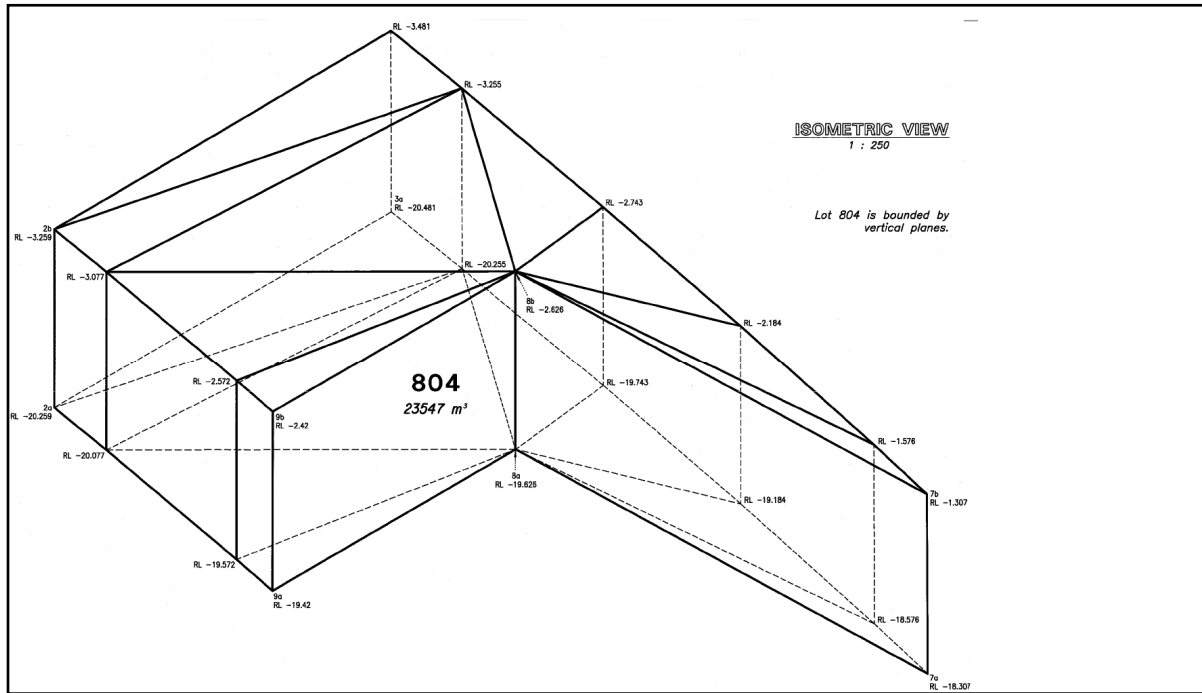

Figure 3. A simple 3D (underground) spatial unit with vertical walls, but with non-horizontal top and bottom

The example in Figure 3 is clearly well catered for in this approach, where the top and bottom have been triangulated to ensure the planarity of all facets. The case in Figure 4 is slightly more complex, because the top and bottom surfaces include some vertical faces which are not part of the outer boundary face strings. These are stored as faces as part of the top or bottom surface, but a simple algorithm allows them to be omitted from the encoding process.

In the common case, where a number of 3D spatial units are defined one above the other (as in the case of units in a tall building), they often share a common footprint, and a top surface of one unit can serve as the bottom of the one above. This is achieved as in the case of boundary face strings by linking a face to the spatial unit inside (from which the face polygon seems clockwise), and to the spatial unit outside (from which it is anticlockwise). For example, if the floors of a building are stored as faces, anticlockwise when viewed from above, they will link to the spatial unit below *inside*, and the spatial unit above *outside*.

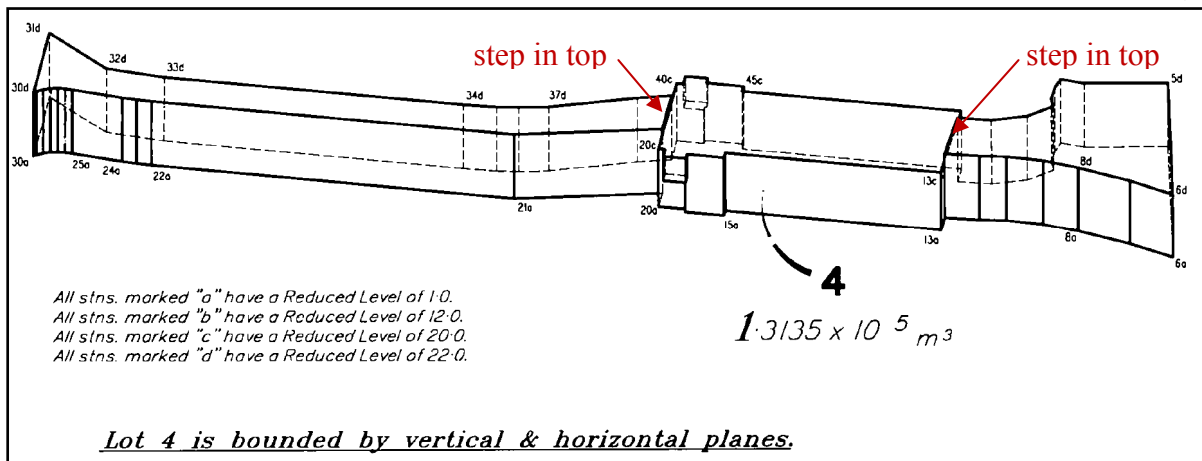

Figure 4. This spatial unit can fairly readily be decomposed into a "footprint" of vertical walls, and well defined sets of faces defining the top and bottom

3.3 Complex 3D spatial units

This is the most generic situation, which is not using the face string to define 3D Spatial Units, as boundaries have arbitrary origination and might even be curved. These Spatial Units are relatively rare, and in some cases, this proposed storage scheme may require more storage space for consistency with the topological encoding than would the conventional 3D polyhedron stored as a set of faces. However, having the 1D line string in 2D space is still useful as it can be applied to depict the footprint of the 3D spatial unit on the traditional 2D cadastral map.

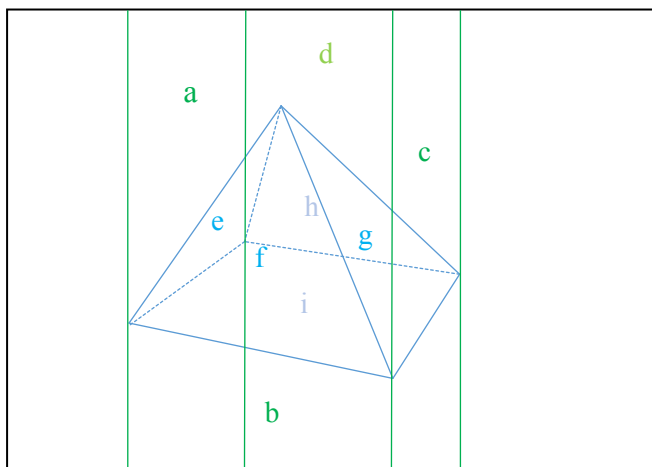

Figure 5. Complex spatial unit in the shape of a pyramid

In the case shown in Figure 5, the face strings a, b, c, d do not add anything to the definition of the pyramid - which is fully defined by faces e, f, g, h, i, but do provide the consistency that permits the database to be viewed as a 2D repository, by simply accessing the boundary face strings as linestrings (Thompson et al 2016). This is a small cost for a significant advantage.

This storage schema does not depend on the concept of a top surface and a bottom surface - it is only described in these words for clarity. Where there is no clear separation, the set of faces

is sufficient as long as the correct orientation of the faces is maintained. Further, if in the survey plan there are multiple 3D spatial units defined, then faces of neighboring spatial units are also shared. Again, this is realized by using references to the shared elements, i.e. the shared faces.

Curved surfaces

Several jurisdictions, as in Queensland or the Netherlands, permit curved boundary lines, and curved boundary surfaces in the definition of cadastral spatial units. As mentioned before, where a spatial unit boundary is defined as curved, the plan must record the details of that curve. While approximating this with short lines and facets is acceptable and often necessary for presentation, the definition in a survey plan is the legal situation. As an example, LandXML is used in a number of jurisdictions (ICSM 2011), and does have some options to define curved lines and surfaces. In practice, the commonly used curves can be accommodated in LandXML (circular arcs, cylindrical faces, conic faces), but not spherical/ellipsoidal surfaces or elliptical lines.

LandXML has 1D primitives (Line, Irregular line, etc.) and 3D primitives (VolumeGeom), but no explicit 2D primitive that can be used in the definition of a “Parcel” (spatial unit). The only geometric elements available within the Parcel element are Center (a point), CoordGeom (collection of line, curve, and/or spiral elements) and VolumeGeom. An assumption is made that a CoordGeom that closes defines a surface, and that if any of the CoordGeom elements are curved, then the simplest curved surface that passes through those lines is intended. For example, in Figure 6, the definition of the two volumes would be identical in LandXML, but the simplest - A would be inferred. This cannot be said to provide a truly unambiguous definition of the spatial unit.

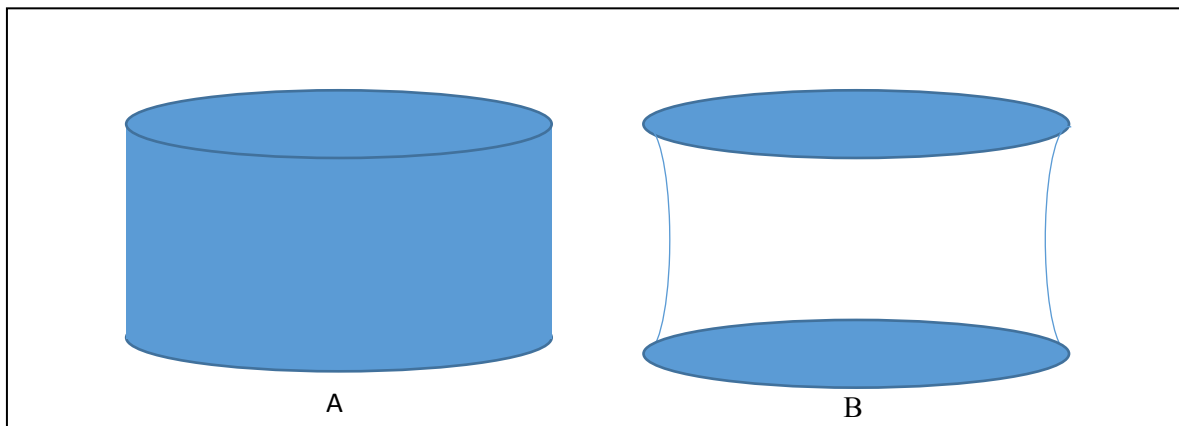

Figure 6. Encoding curved surfaces in LandXML

The storage of spatial units with curved boundaries is identical to that for conventional planar-faced or linear faced spatial units, however the processing is more complex. It must be remembered that the curve of intersection of two simple curved surfaces can be complex to determine (Abdel_Malek et al 1996). Note that the footprint boundary face strings may or may not need to be curved to define a volume with a curved surface.

4. REAL WORLD CASE APPLYING THE TOPOLOGICAL ENCODING

This section discusses a real world use case to demonstrate topological encoding. The case consists of a partially unbounded spatial unit with development where a tunnel (3D spatial unit) has been created underneath.

As shown in Figure 7, initially, the spatial unit was a simple 2D lot with 4 sides, adjoining other lots on two sides, and road on the other. When the tunnel was put through below it, the volume was excised from it below the ground, leaving a remainder lot unbounded above and below. The Queensland survey regulations require that each land parcel affected must be provided with a new plan which defines the surface lot and the volumetric lot. This plan becomes the point of definition for both the surface lot and the subterranean.

After the subdivision shown in Figure 7, the database would contain the following entries in the face strings and faces tables (Table 1 and Table 2):

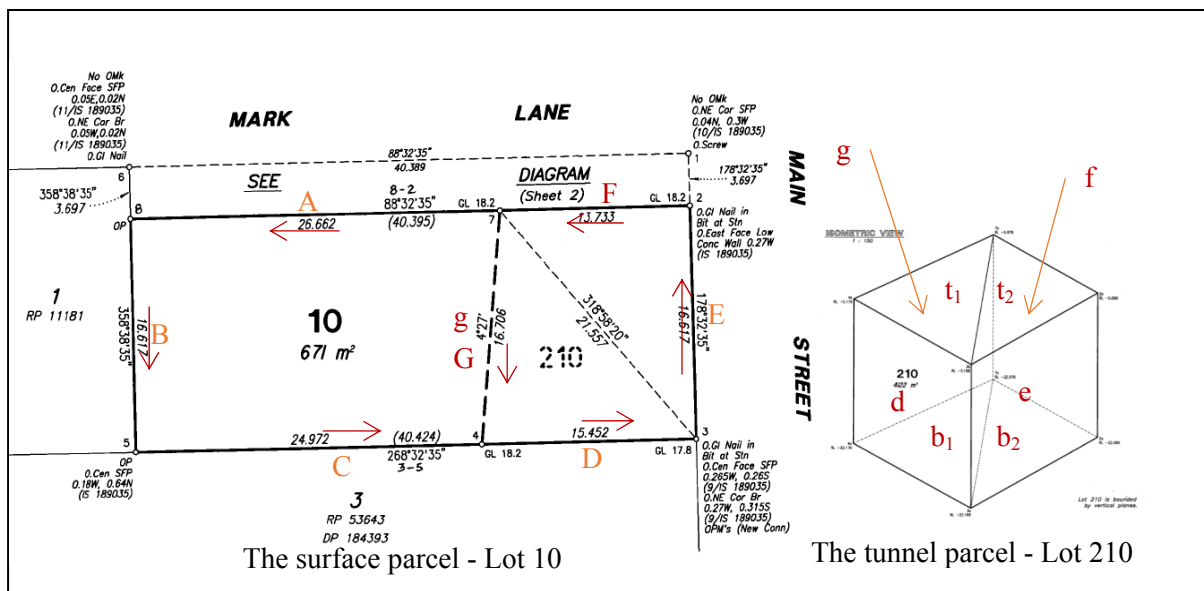

Figure 7. The original surface parcel, and the subsurface parcel being excised. Lines (face strings are labelled in uppercase, faces in lowercase)

Table 1. Face strings (lines, shown in uppercase) (directions as shown by arrows in Figure 7), note the multi-coding of left references at lines D, E, and F: at base layer level (Lot 10), but also for the footprint of the 3D spatial unit (Lot 210)

Line	Left spatial unit(s)	Right spatial unit(s)
A	Lot 10	Road
B	Lot 10	Lot 1/RP11181
C	Lot 10	Lot 3/RP53643
D	Lot 10, Lot 210	Lot 3/RP53643
E	Lot 10, Lot 210	Road
F	Lot 10, Lot 210	Road
G	Lot 210	

Table 2. Faces (faces are shown in lowercase in Figure 7)

Face	Inside spatial unit(s)	Outside spatial unit(s)
t_1	Lot 210	Lot 10
t_2	Lot 210	Lot 10
b_1	Lot 10	Lot 210
b_2	Lot 10	Lot 210
g	Lot 210	Lot 10

Note that there is no need to store faces d, e, f , as they can be generated from the face strings and the top and bottom surfaces, but face g is needed because it is a face of Lot 10.

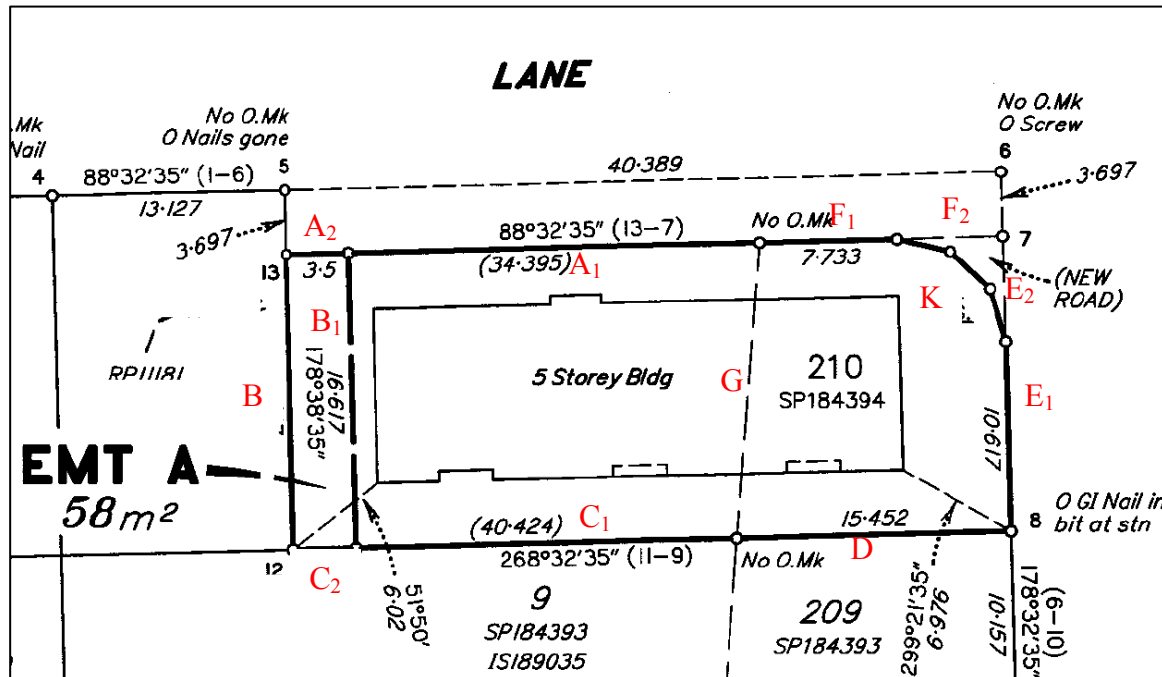

Figure 8. A new five-storey building was constructed on Lot 10

At a later date, a five story building was constructed on Lot 10, an easement (labelled as 'EMT A' in Figure 8) with its own geometry was put through the lot, and the road corner was truncated. This resulted in the creation of the building format plan but had no effect on the tunnel lot (Lot 210). Although Lot 210 is noted on the new plan, its definition is still provided by the previous plan, and the truncation of the corner does not apply to it (Figure 8). Lot 10 then becomes the base lot from which the building format lots are excised. Lot 10 is known from this time on as Lot CP (for Common Property) on the new plan. The tunnel parcel (Lot 210) is unchanged except for the splitting of the face strings (Figure 9). The resulted face strings and faces tables are illustrated in Table 3 and Table 4.

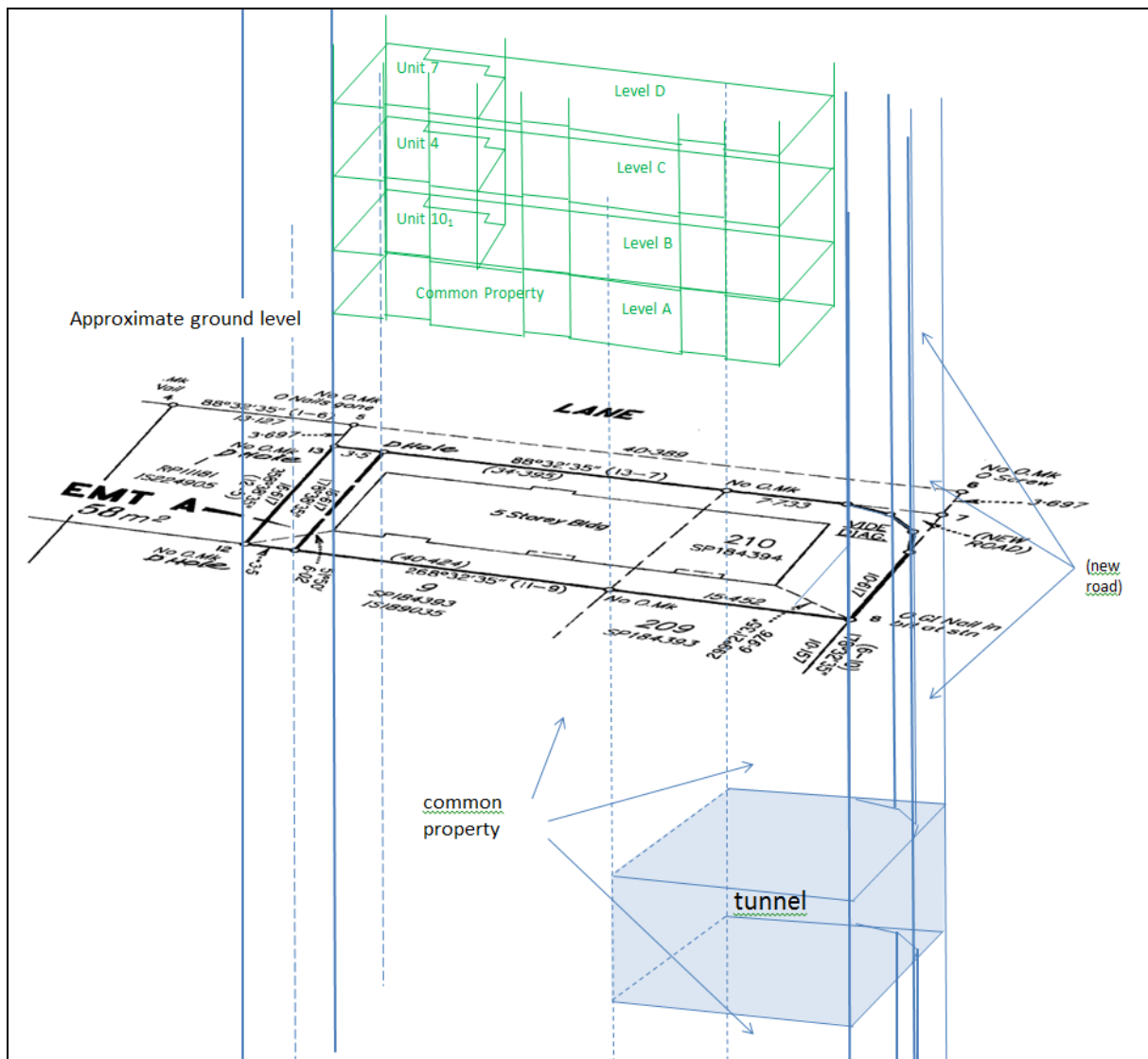

Figure 9. Side view of result after corner truncation and definition of Easement A

Table 3. Face Strings Table after splitting some existing lines (A, C, E, and F) and adding some new lines (B₁ and K) to represent the new easement and the truncated road corner. Note the increased use of multi-coding in the left and right references

Line	Left spatial unit(s)	Right spatial unit(s)
A ₁	Lot CP	Road
A ₂	Lot CP, Easement A	Road
B	Lot CP, Easement A	Lot 1/RP11181
B ₁	Easement A	
C ₂	Lot CP, Easement A	Lot 9/SP184393
C ₁	Lot CP	Lot 9/SP184393
D	Lot CP, Lot 210	Lot 9 and Lot 209/SP184393
E ₁	Lot CP, Lot 210	Road
E ₂	Lot 210	
F ₂	Lot 210	
F ₁	Lot CP, Lot 210	Road
G	Lot 210	Road
K	Lot 10	Road

Table 4. Faces Table. Note that faces t_2 and b_2 are unchanged (remaining simple triangles) because the truncation of the corner of the surface parcel is not applied to the tunnel

Face	Inside spatial unit(s)	Outside spatial unit(s)
t_1	Lot 210	Lot CP
t_2	Lot 210	Lot CP, Road
b_1	Lot CP	Lot 210
b_2	Lot CP, Road	Lot 210
g	Lot 210	Lot CP

Let us now look at the new Building Format plan. Figure 10 and Figure 11 show the details of Level B and Level C of the building, respectively. The corresponding face strings and faces tables are shown in Table 5 and Table 6.

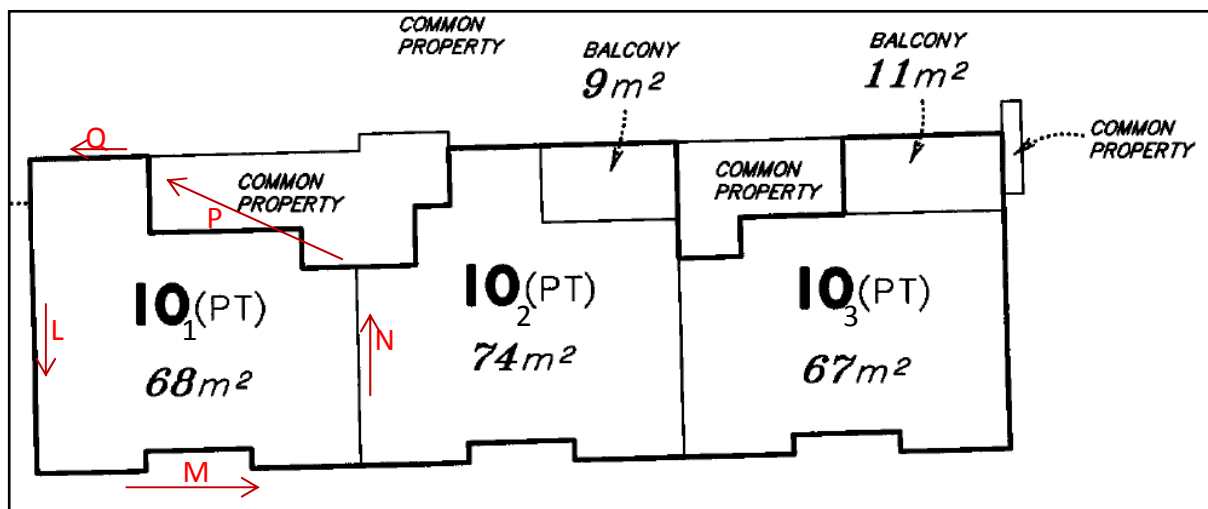

Figure 10. Detail of Level B of the building

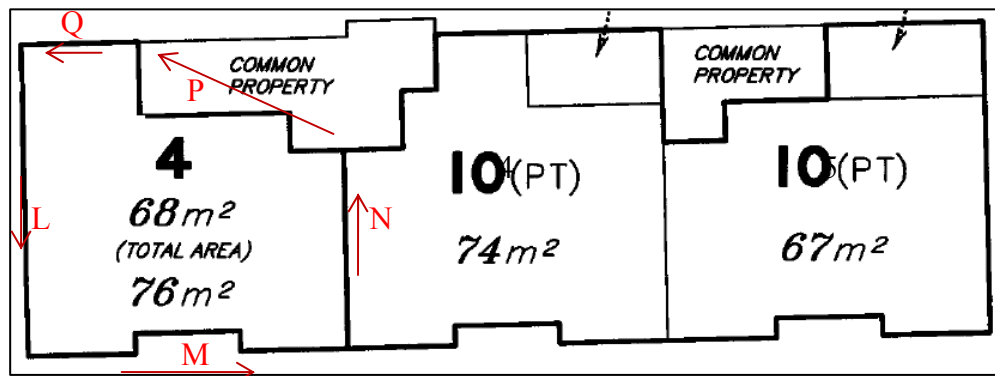

Figure 11. Level C of the building (emphasizing the reuse of lines L, M, N, P, Q at multiple levels in the building)

Table 5. Additional Face Strings (with just the references show at Level B and C in building)

Line	Left spatial unit(s)	Right spatial unit(s)
L	Unit 10 part 1, Unit 4	
M	Unit 10 part 1, Unit 4	
N	Unit 10 part 1, Unit 4	Unit 10 part 2, Unit 10 part 4
P	Unit 10 part 1, Unit 4	
Q	Unit 10 part 1, Unit 4	

Table 6. Additional Faces (all horizontal)

Face	Inside spatial unit(s)	Outside spatial unit(s)
bottom unit 10/1	Unit 10 part 1	Common Property
bottom unit 4	Unit 4	Unit 10 part 1
bottom unit 7	Unit 7 (not in diagram)	Unit 4

Note that for simplicity, this has omitted the void created by excising the units from the base lot (leaving common property). It would be a valid and useful approach to encode so - just recording that the common property is “base lot minus units 4, 7, 10 etc”. If explicit storage of common property including voids is required, faces will need to be generated lying on face strings L, M, N, P, Q to become part of the definition of the common property (as was done in the case of face *g* in Table 2).

In the course of encoding topology, we have formulated a number of tables of faces and face strings. These tables are crucial to extract 2D and 3D objects.

I) Extraction of 2D Objects

To generate polygons, the face strings table is only needed. This can be done by extracting all lines with the object on the left, and reversing those lines with the object on the right (and forming rings with the selected lines). For example:

- Lot 10 prior to the new building being constructed: Lines A, B, C, D, E, F;
- Lot 210 (as 2D polygon): Lines D, E₁, E₂, F₂, F₁, G;
- Lot CP after building: Lines A₁, A₂, B, C₂, C₂, D, E₁, E₂, F₂, F₁, G;
- Unit 4 (as 2D Polygon): Lines L, M, N, P, Q (which would also be the definition of Unit 10 part 1).

II) Extraction of 3D Objects

To generate 3D objects, both tables are needed. One can extract all faces with the object on the inside, and reversing those faces with the object on the outside; plus all extracted face strings as above.

For example:

- Lot 10 prior to building: Face Strings A, B, C, D, E, F; Faces $t_{1(\text{reversed})}$, $t_{2(\text{rev})}$, b_1 , b_2 , $g_{(\text{rev})}$;
- Lot 210: Face Strings D, E₁, E₂, F₂, F₁, G; Faces t_1 , t_2 , $b_{1(\text{rev})}$, $b_{2(\text{rev})}$, g ;
- Lot CP after building: Face Strings A₁, A₂, B, C₂, C₂, D, E₁, E₂, F₂, F₁, G; Faces $t_{1(\text{rev})}$, $t_{2(\text{rev})}$, b_1 , b_2 , $g_{(\text{rev})}$;
- Unit 4: Face Strings L, M, N, P, Q; Faces bottom lot 4, top bottom lot 7_(rev).

5. REPRESENTATION IN LandXML

Figure 12 shows a sample of LandXML encoding for this case, Note some important points:

- The CoordGeom elements do not contain actual coordinates, but reference to point definitions by name (point numbers such as “12”, “13”, for 2D Points, “12a” for 3D).
- Only a small number of FaceStrings, Faces and Parcels have been encoded here.
- The Parcel element is overloaded, and is used for (amongst others) spatial units, faces, face strings, administrative areas, etc.
- A convention is here assumed that a pclRef to a parcel name starting with a minus sign (“-”) is taken as a link to the reverse of the boundary.

- Face strings can be shared by units one above another (e.g. “L”, “M”, etc. shared between units 4, 10/1, 7 etc).
- Currently the 3D faces as specified by CoordGeom are permitted to consist of a list of point coordinates, with neighbouring faces containing duplicate point coordinates. A ‘more topological’ encoding of the faces is used here, based on referring to the points by name, and where points are shared by neighbouring faces (similar to the VRML/ X3D-like index set of points).

```

<Parcel class="FaceString" name="B">
  <CoordGeom><Line><Start pntRef="13"/><End pntRef="12"/></Line>
  ...</CoordGeom>
</Parcel>
<Parcel class="FaceString" name="C2">
  <CoordGeom>...</CoordGeom>
</Parcel>
<Parcel class="FaceString" name="N">
  <CoordGeom>...</CoordGeom>
</Parcel>
...
<Parcel class="Face" name="t2">
  <CoordGeom desc="Polygon3D">...</CoordGeom>
</Parcel>
<Parcel class="Face" name="Bottom Lot 10/1">
  <CoordGeom desc="Polygon3D">...</CoordGeom>
</Parcel>
...
<Parcel class="Easement" name="A" parcelFormat="Standard">
  <Parcels>
    <Parcel pclRef="B" />    <Parcel pclRef="C2" />
    <Parcel pclRef="B2" />  <Parcel pclRef="A2" />
  </Parcels>
</Parcel>
<Parcel class="LOT" name="4" parcelFormat="Volumetric">
  <Parcels>
    <Parcel pclRef="L" />    <Parcel pclRef="M" />
    <Parcel pclRef="N" />    <Parcel pclRef="P" />
    <Parcel pclRef="Q" />    <Parcel pclRef="-Bottom Lot 10/1" />
    <Parcel pclRef="Bottom Lot 4" />
  </Parcels>
</Parcel>
<Parcel class="LOT" name="10/1" parcelFormat="Volumetric">
  <Parcels>
    <Parcel pclRef="L" />    <Parcel pclRef="M" />
    <Parcel pclRef="N" />    <Parcel pclRef="P" />
    <Parcel pclRef="Q" />    <Parcel pclRef="Bottom Lot 10/1" />
    <Parcel pclRef="-Bottom Lot 7" />
  </Parcels>
</Parcel>
<CgPoint name="12" state="existing" oID="6636442"
  pntSurv="boundary">2000 1000</CgPoint>
<CgPoint name="13" state="existing" oID="6630143"
  pntSurv="boundary">1999.891 1016.617</CgPoint>

```

Figure 12. Sample of encoding in LandXML

6. CONCLUSIONS AND FUTURE WORK

6.1 Main results

This paper has presented a conceptual model applied to topology encoding of range of spatial units (2D, simple 3D, complex 3D). It supports elegant fusing of the 2D and the 3D representations with key role for the 1D line string in 2D space, which becomes a 2D face string in 3D space. Also, this line string is used to depict footprints of the 3D spatial units in traditional 2D cadastral maps. The further benefits of the proposed conceptual model and the topology encoding are: fitting to current cadastral survey practice, efficient encoding, explicit semantics on neighbors, reduction of redundancy, avoiding inconsistencies. The conceptual model for survey plans have been expressed in the language of the LADM. A multi-step actual real world example, is given and encoded according to this conceptual model in LandXML for exchange purposes, including the initial registration.

5.2 Future work

Future work includes investigating more types of 3D Cadastral parcels real world cases. It should be noted that in the future not all survey plans may originate from surveys, but quite a number of them might results from design; e.g. BIM/IFC (Atazadeh et al, 2016). Also, here too the role of topology is of equal importance, and topology encoding from this source needs further investigations. Currently, in many legislations the survey plan (paper hard copy) is an official, legal document. The issue of the digital document being the official document needs further investigation (on aspects such as long term preservation, digital signatures, approvals, etc.). This is quite similar to the treatment of administrative legal documents (Deeds) in the Netherlands. The digital Deeds have become legal documents and are submitted via the ELAN system (Stolk and Lemmen, 2003). These digital deeds now form the large majority of submitted, approved and recorded legal administrative documents. Finally, it has been suggested in the introduction that a topology representation as proposed for the survey plans, could also be applied to the cadastral database. Future work should explore how this can be realized: integrating the topology island from the survey plan into the topology structure of the complete cadastral database. The ultimate goal is to integrate the survey data with the cadastral map data in an integrated database (van Oosterom et al 2011).

REFERENCES

- Abdel_Malek, K. and Yeh, H.J. (1996). Determining intersection curves between surfaces of two solids, Publisher. Computer-Aided Design 28(6/7): 539-549.
- Atazadeh, B., Kalantari, M., Rajabifard, A., Champion, T. and Ho, S. (2016). Harnessing BIM for 3D Digital Management of Stratified Ownership Rights in Buildings. In proceedings FIG Working Week 2016.
- Baumgart, B. G. (1972). Winged Edge Polyhedron Representation. Stanford Artificial Intelligence Project: 44, Document STAN-CS-72-320 Memo AIM-179, from <http://www.dtic.mil/dtic/tr/fulltext/u2/755141.pdf>.
- Boguslawski, P. and Gold, C. (2009). Construction Operators for Modelling 3D Objects and Dual Navigation Structures. Lecture notes in goinformation and cartography: 3d Geoinformation Sciences, Part II. S. Zlatanova and J. Lee, Springer: 47-59.
- de Hoop, S., van Oosterom, P. and Molenaar, M. (1993). Topological Querying of Multiple Map Layers. COSIT'93 European Conference on Spatial Information Theory. Italy: 139-157.
- Hoel, E., Menon, S. and Morehouse, S. (2003). Building a Robust Relational Implementation of Topology. Submitted to the 8th International Symposium on Spatial and Temporal Databases.
- ICSM (2011). ePlan Protocol LandXML Mapping. 12/08/2011, from <https://icsm.govspace.gov.au/files/2011/09/ePlan-Protocol-LandXML-Mapping-v2.1.pdf>.
- LandXML. (2016, April 2016). "LandXML.org." Retrieved Aug 2016, from www.landxml.org.
- Ledoux, H. and Gold, C. (2007). Simultaneous Storage of Primal and Dual Three-Dimensional Subdivisions, Publisher. Computers, Environment and Urban Systems 31: 393-408.
- Lemmen, C., Van Oosterom, P., Thompson, R. J., Hespanha, J. and Uitermark, H. (2010). The Modelling of Spatial Units (Parcels) in the Land Administration Domain Model (LADM). FIG Congress 2010, Sydney, Australia.
- Louwsma, J. H. (2003). "Topology versus non-topology storage structures.", from http://www.gdmc.nl/publications/2003/Topology_storage_structures.pdf.
- Stolk, P. and Lemmen, Ch. (2003). Technical Aspects of Electronics Conveyancing. In proceedings of the 2nd FIG Regional Conference. Marrakech, Morocco, December 2-5, 2003.
- Thompson, R., van Oosterom, P., Karki, S. and Cowie, B. (2015). A Taxonomy of Spatial Units in a Mixed 2D and 3D Cadastral Database. FIG Working Week 2015. Sofia, Bulgaria.

Thompson, R. J., van Oosterom, P., Soon, K. H. and Priebbenow, R. (2016). A Conceptual Model Supporting a Range of 3D Parcel Representations through all Stages: Data Capture, Transfer and Storage. FIG Working Week. Christchurch NZ.

van Oosterom, P., Stoter, J., Quak, W. and Zlatanova, S. (2002). The Balance Between Geometry and Topology. 10th International Symposium on Spatial Data Handling, Ottawa, Canada, Springer-Verlag, Berlin.

van Oosterom, P. (2000). Research issues in integrated querying of geometric and thematic cadastral information (2), Technical report, Delft University of Technology, 33 pages.

van Oosterom, P., Lemmen, Ch., Uitermark, H., Boekelo, G. and Verkuil G. (2011). Land Administration Standardization with focus on Surveying and Spatial Representations. In Proceedings of the ACMS Annual Conference Survey Summit 2011, San Diego, 2011.

BIOGRAPHICAL NOTES

Rodney James Thompson has been working in the spatial information field since 1985. He designed and led the implementation of the Queensland Digital Cadastral Data Base, and is now advising on spatial database technology with an emphasis on 3D and temporal issues. He obtained a PhD at the Delft University of Technology in December 2007.

Peter van Oosterom obtained an MSc in Technical Computer Science in 1985 from Delft University of Technology, the Netherlands. In 1990 he received a PhD from Leiden University. From 1985 until 1995 he worked at the TNO-FEL laboratory in The Hague. From 1995 until 2000 he was senior information manager at the Dutch Cadastre, where he was involved in the renewal of the Cadastral (Geographic) database. Since 2000, he is professor at the Delft University of Technology, and head of the 'GIS Technology' Section, Department OTB, Faculty of Architecture and the Built Environment, Delft University of Technology, the Netherlands. He is the current chair of the FIG Working Group on '3D Cadastres'.

Kean Huat Soon is Principal Surveyor at the Land Survey Division of Singapore Land Authority. He is technical lead in the 3D National Mapping project and the development of the new cadastral system to support 3D Cadastres and automated cadastral processing. He earned a MSc in Geography from the Pennsylvania State University, a MSc in Geoinformatics and Bachelor of Surveying (Land) from University of Technology Malaysia. His research interests include semantic interoperability, data modeling, cadastral information system and ontology.

CONTACTS

Rod Thompson

Queensland Government/ \Department of Natural Resources and Mines
Landcentre, Cnr Main and Vulture Streets,
Woolloongabba, Brisbane, Queensland 4102

AUSTRALIA

Phone: +61 7 38963286

E-mail: Rod.Thompson@qld.gov.au

Website: <http://www.dnrm.qld.gov.au/>

Peter van Oosterom

Delft University of Technology

Faculty of Architecture and the Built Environment

Department OTB, GIS Technology Section

P.O. Box 5030

2600 GA Delft

THE NETHERLANDS

Phone: +31 15 2786950

E-mail: P.J.M.vanOosterom@tudelft.nl

Website: <http://www.gdmc.nl>

Kean Huat Soon

Singapore Land Authority

55 Newton Road, #12-01, Revenue House

Singapore 307987

SINGAPORE

Phone: +65 6478 3537

Fax: +65 6323 9937

E-mail: soon_kean_huat@sla.gov.sg

Website: <http://www.sla.gov.sg/>