

Wavefront control with a multi-actuator adaptive Lens in imaging applications

Mocci, J.; Cua, M.; Lee, S.; Jian, Y.; Pozzi, P.; Quintavalla, M.; Trestino, C.; Verstraete, H.; Wahl, D.; Muradore, R.

DOI

[10.1117/12.2250016](https://doi.org/10.1117/12.2250016)

Publication date

2017

Document Version

Final published version

Published in

Proceedings of SPIE

Citation (APA)

Mocci, J., Cua, M., Lee, S., Jian, Y., Pozzi, P., Quintavalla, M., Trestino, C., Verstraete, H., Wahl, D., Muradore, R., Zawadzki, R. J., Verhaegen, M., Sarunic, M. V., & Bonora, S. (2017). Wavefront control with a multi-actuator adaptive Lens in imaging applications. In T. G. Bifano, J. Kubby, & S. Gigan (Eds.), *Proceedings of SPIE: Adaptive Optics and Wavefront Control for Biological Systems III* (Vol. 10073). [1007302] (Proceedings of SPIE; Vol. 10073). SPIE. <https://doi.org/10.1117/12.2250016>

Important note

To cite this publication, please use the final published version (if applicable).
Please check the document version above.

Copyright

Other than for strictly personal use, it is not permitted to download, forward or distribute the text or part of it, without the consent of the author(s) and/or copyright holder(s), unless the work is under an open content license such as Creative Commons.

Takedown policy

Please contact us and provide details if you believe this document breaches copyrights.
We will remove access to the work immediately and investigate your claim.

PROCEEDINGS OF SPIE

[SPIDigitalLibrary.org/conference-proceedings-of-spie](https://spiedigitallibrary.org/conference-proceedings-of-spie)

Wavefront control with a multi-actuator adaptive Lens in imaging applications

J. Mocci
M. Cua
S. Lee
Y. Jian
P. Pozzi
M. Quintavalla
C. Trestino
H. Verstraete
D. Wahl
R. Muradore
R. J. Zawadzki
M. Verhaegen
M. V. Sarunic
S. Bonora

Wavefront control with a Multi-actuator Adaptive Lens in imaging applications

^aJ. Mocci, ^cM.Cua, ^cS.Lee, ^cY.Jian, ^bP.Pozzi, ^dM.Quintavalla, ^dC.Trestino, ^bH.Verstraete, ^cD.Wahl, ^aR.Muradore, ^cR.J. Zawadzki, ^bM.Verhagen, ^cM.V. Sarunic, and ^dS.Bonora

^aUniversità di Verona, Dipartimento di Informatica, Via Le Grazie, Verona, Italy

^bDelft Center for Systems and Control, Delft University of Technology, Mekelweg 2, 2628 CD, Delft, Netherlands

^cSchool of Engineering Science, Simon Fraser University, 8888 University Drive, Burnaby, BC, V5A 1S6, Canada

^dCNR-Institute of Photonics and Nanotechnology, via Trasea 7, Padova, Italy

^eUC Davis RISE Small Animal Ocular Imaging Facility, Department of Cell Biology and Human Anatomy, University of California Davis, Davis, CA 95616, USA

ABSTRACT

The use of adaptive lenses instead of deformable mirrors can simplify the implementation of an adaptive optics system. The recently introduced Multi-actuator Adaptive Lens (MAL) can be used in closed loop with a wavefront sensor to correct for time-variant wavefront aberrations. The MAL can guarantee a level of correction and a response time similar to the ones obtained with deformable mirrors. The adaptive lens is based on the use of piezoelectric actuators and, without any obstruction or electrodes in the clear aperture, can guarantee a fast response time, less than ~10ms. Our tests show that the MAL can be used both in combination with a wavefront sensor in a “classical” adaptive optics closed loop, or in a wavefront sensorless configuration. The latter has allowed us to design more compact and simple imaging systems for different microscopy platforms. We will show that the Multi-actuator Adaptive Lens has been successfully used for in-vivo OCT ophthalmic imaging in both mice and humans, as well as confocal and two photon microscopy. We tested and compared different optimization strategies such as coordinate search and the DONE algorithm. The results suggest that the MAL optimization can correct for eye aberrations with a pupil of 5mm or sample induced aberrations in microscopy.

Keywords: Adaptive Optics, OCT, Adaptive Lens, wavefront sensorless

1. INTRODUCTION

The Multi actuators Adaptive Lens (M-AL), can correct aberrations up to the 4th order. The M-AL has the potential to increase the diffusion of adaptive optics to many new applications by simplifying the integration of a wavefront corrector inside existing systems.

As examples of the advantages of the use of the M-AL we present its integration in two different in-vivo bio-imaging platforms such as an OCT ophthalmoscope for human retina and a 2-photon ophthalmoscope for small animals.

2. ADAPTIVE LENS

The Multi actuator-Adaptive Lens designed at CNR can generate aberrations up the Zernike 4th order. A detailed description of the adaptive lens can be found in [1]. The M-AL offers the same functionalities of a deformable mirror. The advantage is the easiness of integration inside existing systems. Fig. 1 shows the adaptive lens integrated inside a microscope just by placing it on the back aperture of the objective.

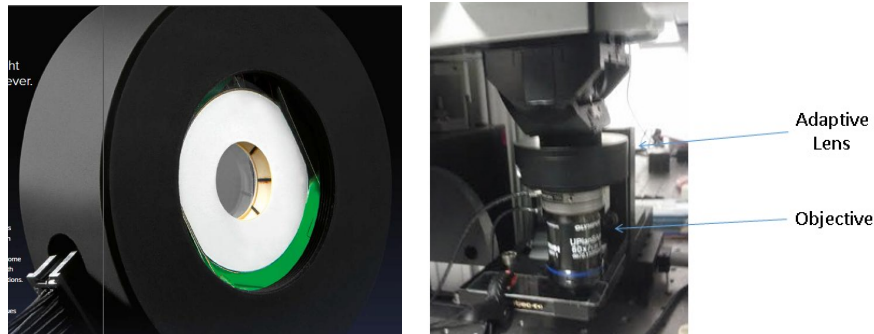

Figure 1. Left: adaptive lens. Right: adaptive lens mounted on a microscope objective.

The idea we show in this paper is the combined use of the M-AL with a wavefront sensorless control algorithm (see section 3 for more details on the algorithms). Fig. 2 shows the comparison between a simple microscope (Fig. 2a) and a microscope mounting an adaptive optics system based on closed loop control (Fig. 2b). By the use of the adaptive lens, instead of a deformable mirror, and by the use of wavefront sensorless control, the system is strongly simplified (Fig. 2c).

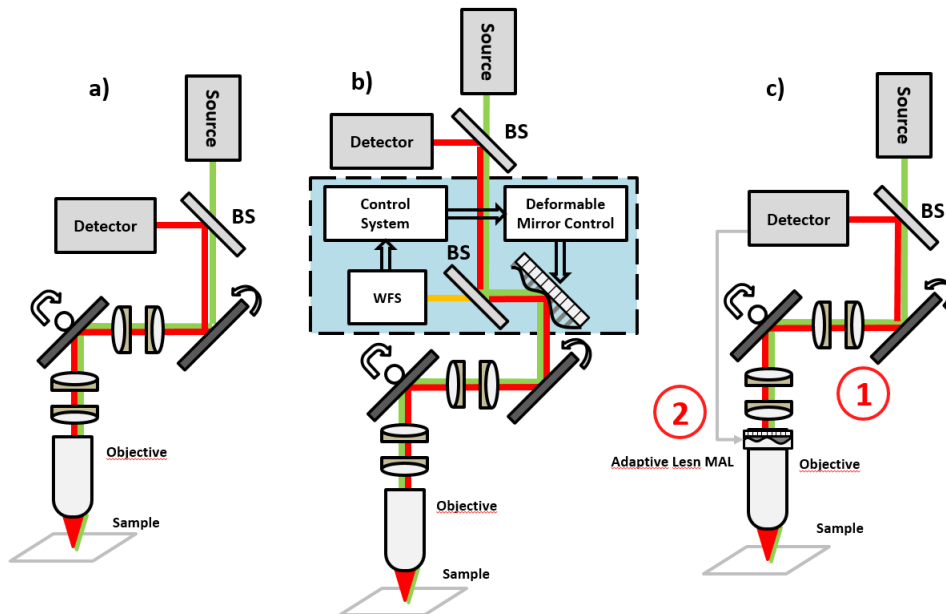

Figure 2: a) block diagram of a generic microscope. b) block diagram of a generic microscope using adaptive optics with a deformable mirror and a wavefront sensor. c) the same microscope using an adaptive lens instead of a DM and a wavefront sensorless control.

An additional advantage of the wavefront sensorless control is that it can be used without a point like source for feeding the wavefront sensor.

2.1 Adaptive lens compared with DMs

To demonstrate the capabilities of the M-AL we compared it with two different deformable mirrors in the generation of Zernike polynomials. The first one is an electrostatic membrane DM (32 actuators, PAN, Adaptica srl) and 19 actuators bimorph deformable mirror. All the devices have got a clear aperture of 10mm.

The performances of the devices were evaluated operating them in closed loop using a Shack Hartmann wavefront sensor.

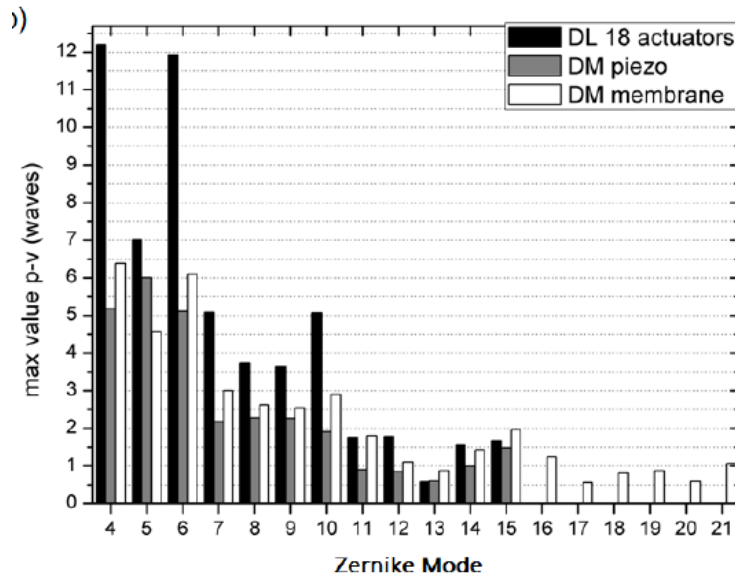

Figure 3: Peak-to-valley amplitude of the Zernike polynomials that can be generated by 18-actuators Deformable Lens (DL black bars), 19-actuators piezoelectric DM (gray bars) and 32-actuators membrane DM (white bars), using the adaptive lens in closed loop.

Figure 2 shows the maximum amount peak to valley amplitude of Zernike polynomials that is possible to generate using the three devices. The M-AL was able to generate the maximum wavefront displacement in all the cases except for polynomials of order larger than the 4th.

3. WAVEFRONT SENSORLESS ALGORITHM

3.1 Coordinate search

With the aim to simplify the use of adaptive optics, we have implemented a wavefront sensorless control algorithm [2 - 7]. Using this algorithm was possible to mount the adaptive lens adjacent to the objective lens of the system as shown in the Fig. 1. The algorithm performs the image optimization by the application of bias aberration to the system and by measuring the image sharpness of each of them. The Fig. 4 reports the basic principle of this method. For large value of the aberration, the image is blurry and therefore the merit function has a low value. The system finds the value of the bias aberration that gives the best merit and the sharpest image.

In order to achieve this purpose the adaptive lens was previously characterized by a wavefront sensor that measured the influence functions matrix.

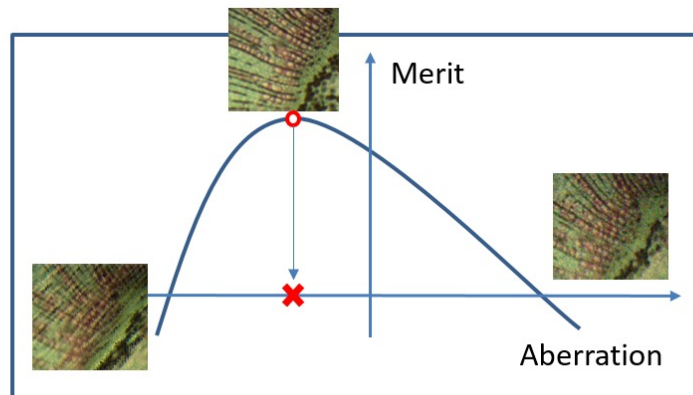

Figure 4: in order to find the maximum value of the merit function each aberration is scanned.

Fig. 5 reports some PSFs recorded placing a camera in the focal plane as an example of the reliability of the M-AL in the generation of pure Zernike wavefronts.

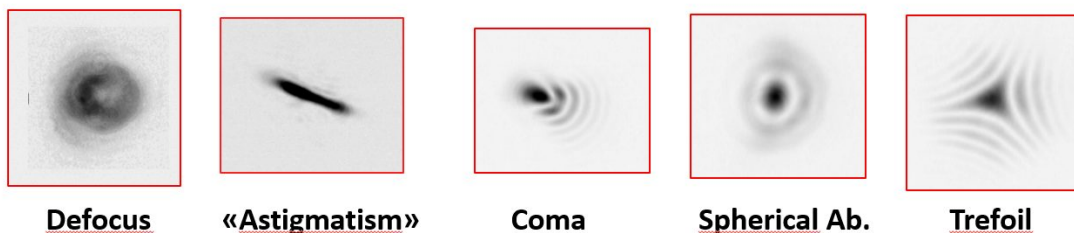

Figure 5: PSFs measured placing a camera in the focal plane during the aberration scan. The PSFs were generated without a wavefront sensor.

3.2 Hysteresis

The adaptive lens is realized with piezoelectric actuators. Therefore, the displacement of the adaptive lens is subjected to an error due to the hysteresis. This error can be as high as 15% of the total adaptive lens displacement. While this is not important for closed loop control, it plays a fundamental role in wavefront sensorless optimization. Fig. 5 shows a simple algorithm that can be used for compensating the hysteresis. The first step is to operate a “relax” operation, which is a sinusoidal excitation of all the actuators with decreasing value, in order to discharge the hysteresis. After that the aberration is scanned through positive values, subsequently we go back to the origin with a relax. At this point we scan the aberration towards negative entries and “relax” back again. Afterwards we have the information about the best merit value and we can apply it. This method has been applied in Refs. 2- 7 demonstrating to be reliable. Its main disadvantage is that the relax operations are the slower part of optimization procedure.

Algorithm

- 1 – go to the origin
- 2 – Scan positive aberration entries
- 3 – relax back to origin
- 4 – Scan negative aberration entries
- 5 – Relax back to origin
- 6 – Go to Max

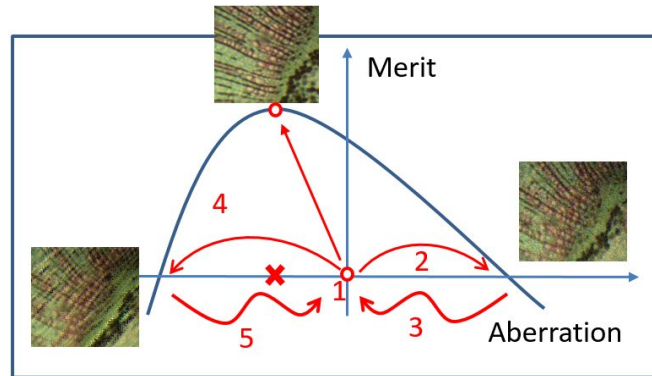

Figure 6: procedure to reduce the hysteresis error during the coordinate search optimization.

3.3 DONE algorithm

The Data-based Online Nonlinear Extremum-seeker (DONE) algorithm was first described for WFSL-AO in OCT [8]. In contrast to the aforementioned algorithms that take the measurement with the lowest (or highest) metric value, DONE was explicitly designed to take all past measurements into account such that the robustness of the algorithm with respect to noise is increased.

To apply the DONE algorithm we developed a linearization algorithm for the hysteresis correction. This method allowed us to directly apply the correction without any time costly “relax” operation. The method used for hysteresis correction directly approximates the inverse hysteresis curve with a combination of a polynomial and a Prandtl-Ishlinskii (PI) model [9].

4. IN-VIVO OPTIMIZATION

We tested the use of the M-AL with sensorless control in in-vivo OCT platforms for imaging of both human and mice retina. Details on the OCT systems can be found in [1-9]. We applied the coordinate search (or hill climbing) algorithm correction in the systems [1-8] and, recently, we used the DONE algorithm. The results presented in Ref. 6 describe the use of the M-AL in the optimization of a 2-Photon system for the imaging of mice retina. In order to reduce at minimum the irradiation of retina with high intensity laser pulses, in this experiment, the optimization was carried out with the OCT signal obtained with the same laser source used for the 2P imaging. The preliminary results are shown in Fig. 7.

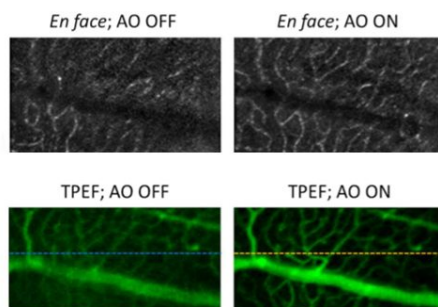

Figure 7. Images acquired by the 2-Photon system are described in Ref. 6. The optimization was carried out on the OCT signal as shown in the top row and, at the end of it, we acquired the 2P images.

We also compared the use of the DONE algorithm to the coordinate search (detailed results are reported in Ref. [8-9]). The experimental results show that the DONE algorithm is more robust to noise and faster than coordinate search. Both those advantages play a very important role in in-vivo imaging. Systems designed for clinical use will have important benefit from this optimization technique.

REFERENCES

- [1] Stefano Bonora, Yifan Jian, Pengfei Zhang, Azhar Zam, Edward N. Pugh, Robert J. Zawadzki, and Marinko V. Sarunic, "Wavefront correction and high-resolution in vivo OCT imaging with an objective integrated multi-actuator adaptive lens," *Opt. Express* 23, 21931-21941 (2015)
- [2] S. Bonora, R.J. Zawadzki, "Sensorless modal deformable mirror correction in Adaptive Optics - Optical Coherence Tomography", *Optics Letters* 38 (22), pp. 4801-4804, 2013
- [3] Yifan Jian, Jing Xu, Martin A. Gradowski, Stefano Bonora, Robert J. Zawadzki, and Marinko V. Sarunic, "Wavefront sensorless adaptive optics optical coherence tomography for in vivo retinal imaging in mice", *Biomedical Optics Express*, Vol. 5, Issue 2, pp. 547-559 (2014)
- [4] K.S.K. Wong, Y. Jian, M. Cua, S. Bonora, R.J. Zawadzki, M.V. Sarunic, "In vivo imaging of human photoreceptor mosaic with wavefront sensorless adaptive optics optical coherence tomography", *Biomed. Opt. Express* 6, 580-590 (2015)
- [5] Yifan Jian, Sujin Lee, Myeong Jin Ju, Morgan Heisler, Weiguang Ding, Robert J. Zawadzki, Stefano Bonora & Marinko V. Sarunic, "Lens-based wavefront sensorless adaptive optics swept source OCT", *Scientific Reports* 6, Article number: 27620
- [6] Michelle Cua, Daniel J Wahl, Yuan Zhao, Sujin Lee, Stefano Bonora, Robert J Zawadzki, Yifan Jian, Marinko V Sarunic, "Coherence-Gated Sensorless Adaptive Optics Multiphoton Retinal Imaging", *Scientific Reports* 6, 2016
- [7] Daniel J. Wahl, Yifan Jian, Stefano Bonora, Robert J. Zawadzki, and Marinko V. Sarunic, "Wavefront sensorless adaptive optics fluorescence biomicroscope for in vivo retinal imaging in mice" *Biomed. Opt. Express* 7, 1-12 (2016)
- [8] Hans R. G. W. Verstraete, Sander Wahls, Jeroen Kalkman, and Michel Verhaegen, "Model-based sensor-less wavefront aberration correction in optical coherence tomography," *Opt. Lett.* 40, 5722-5725 (2015)
- [9] H.R.G.W.Verstraete, Morgan Heisler, M.J. Ju, D.Wahl, L.Bliek, J.Kalkman, S.Bonora, Y.Jian, M.Verhaegen, and M.Sarunic, "Wavefront sensorless adaptive optics OCT with the DONE algorithm for in vivo human retinal imaging", in preparation.