

Mapping double-curved surfaces for production of precast concrete shell elements

Schipper, H. R.; Eigenraam, P.

Publication date

2016

Document Version

Final published version

Published in

Heron

Citation (APA)

Schipper, H. R., & Eigenraam, P. (2016). Mapping double-curved surfaces for production of precast concrete shell elements. *Heron*, 61(3), 211-233.

Important note

To cite this publication, please use the final published version (if applicable).
Please check the document version above.

Copyright

Other than for strictly personal use, it is not permitted to download, forward or distribute the text or part of it, without the consent of the author(s) and/or copyright holder(s), unless the work is under an open content license such as Creative Commons.

Takedown policy

Please contact us and provide details if you believe this document breaches copyrights.
We will remove access to the work immediately and investigate your claim.

Mapping double-curved surfaces for production of precast concrete shell elements

H.R. Schipper¹, P. Eigenraam²

¹ Faculty of Civil Engineering and Geosciences, Delft University of Technology,
P.O. Box 5048, 2600 GA Delft, the Netherlands

² Faculty of Architecture and the Built Environment, Delft University of Technology,
the Netherlands

Practical implications of deforming a flat mould surface into a double-curved shape. Proposal for processing concrete elements with a complex double-curved geometry in an efficient and accurate manner using parametric, associative modelling.

Keywords: Flexible mould, precast concrete, Gaussian curvature, parametric associative modelling, shear deformation

1 Introduction

Shells have become too expensive; can precasting be a solution?

The construction of monolithic concrete shell structures has become expensive, outpricing these shells in Western countries, when compared to other structural options [Mungan and Abel, 2011]. Monolithic shells, due to their double-curved shape and large spans, require labour-intensive formwork and falsework, placement of curved reinforcement and in-situ casting under a slope [Bösiger, 2011]. Although the use of precast technology is common for many other types of concrete structures, for shells, precasting has not been applied very often. Could precasting revive concrete shells again? This article will address a necessary step towards technical and economic feasibility of precasting: the application of a reusable and adaptive formwork. More specifically, the article will outline a parametric, associative approach to describe the kinematics of the mould deformation and position of mould contours.

Recent studies on precasting with a flexible formwork

Intuitively, the distribution of a monolithic shell into smaller precast elements seems to result in many challenges, among which are: 1) potential deterioration of buckling behaviour as a result of stiffness reduction in the connections, 2) introduction of a large number of connections between precast shell elements, 3) no change in the need for a temporary support structure, and finally 4) a large number of expensive moulds to precast the double-curved shapes, generally moulds with a low repetition factor, due to the irregular shape of shells.

Some of these challenges have been studied [Moiralis, 2013; Witterholt, 2016] in recent years, promising solutions for the first three issues mentioned. Therefore, the present article will specifically address the fourth issue: how to economically manufacture many double-curved precast shell elements with varying shape and curvature, solving the mould challenge? This will be elaborated around the concept of a *flexible mould*.

Figure 1 illustrates the concept of *deformation after casting* in an open, adaptive, and reusable flexible mould. This flexible mould concept was investigated in detail during the PhD study of the first author [Schipper, 2015]. In this PhD study, various aspects such as concrete rheology, reinforcement, and cracking risk were researched in detail. Ideas where

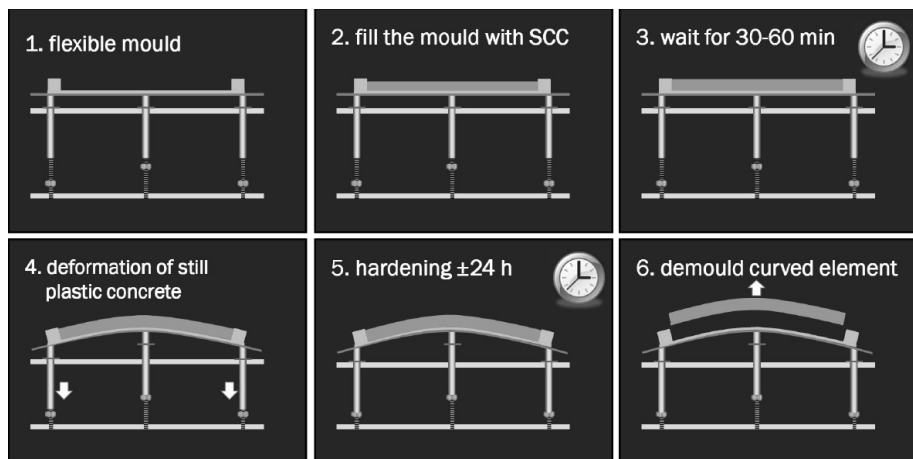

Figure 1: Principle of deforming concrete after casting, using a (1) flexible mould: a self-compacting concrete element is cast (2) in the mould, and after an brief period of initial stabilisation of the mixture (3), the element is deformed by changing the height of the vertical supports, the so-called actuators, (4) into its final shape. After approx. 24 hours of hardening (5), the element can be demoulded (6), after which the flexible mould can be reconfigured and reused, possibly with different element contours and curvature.

developed as to how an industrial production line could be designed with the concept of a flexible mould.

2 Large deformations

Kinematic and elastic difficulties

A particular challenge that was not solved completely during the above-mentioned PhD study, was the *kinematic and elastic behaviour of the mould surface*. Accurate deformation of a reusable mould surface into the desired double-curved shape appeared less trivial than one might think at first glance: for non-stretchable materials it even is fundamentally impossible. For most elastic materials, that could potentially be used as a flexible formwork, the forces needed for deformation can become very large if a continuous mould surface is used. This is caused by the fact that the thickness of this surface is bound to a certain minimum: deflections between the actuators due to the concrete weight might otherwise become visible in the final concrete element (so called *ponding*) or buckling due to in-plane compressive stresses could occur. These effects can be prevented in two ways: 1) using a denser grid of actuators - thus reducing the buckling length and distributing the forces over more actuators, or 2) using a thicker mould surface - thus reducing buckling risk and ponding, but requiring more powerful actuators. However, economic and industrial arguments speak against this approach. For any large project, typically hundreds to even thousands of concrete elements will have to be cast. Multiple flexible moulds will be needed to obtain a sufficiently quick production time. The use of light gravity-driven actuators to deform the mould is much less expensive than the use of powerful pneumatically, hydraulically or electrically actuated support points. In Schipper [2015], a hybrid solution of automated pin set-up in combination with gravity-driven deformation (see Figure 2) was proposed. For this, limited elastic resistance of the mould surface is required. The second author of the present article, already touched on a possible solution for this, namely a mould based on the principle of *shear deformation* [Eigenraam, 2013].

In Eigenraam and Schipper [2015], a prototype using the shear deformation principle was elaborated in more detail, including the underlying equation of Gauss. The present article will discuss a parametric-associative approach to solve the geometrical complexity of deforming a flat mesh into a double-curved one, using shear deformation. Let's first have a look at where actually the difficulties are.

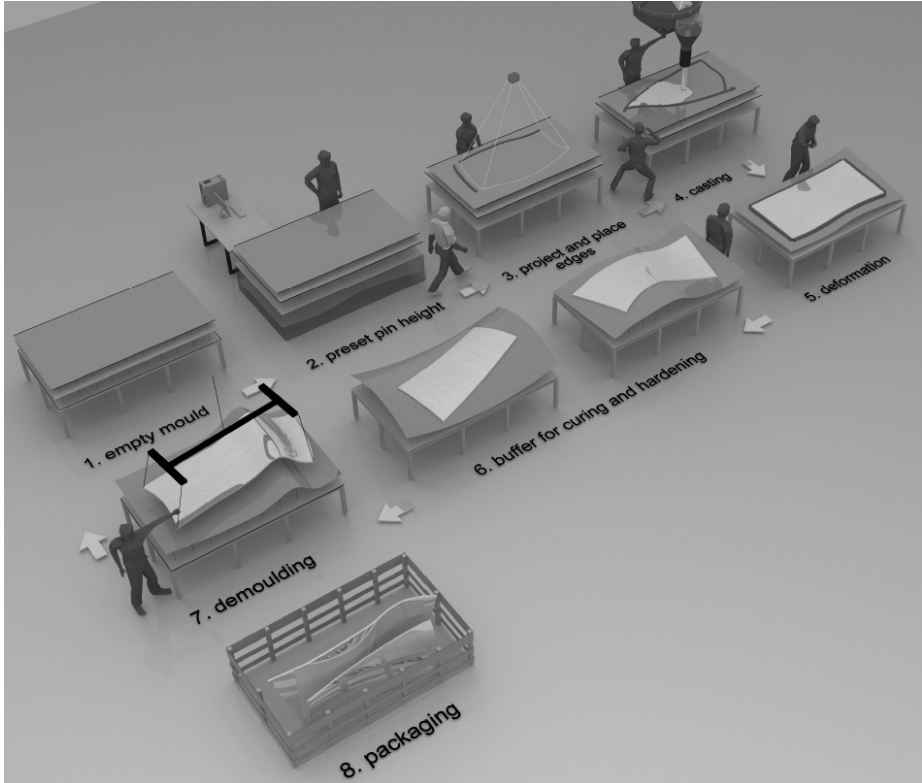

Figure 2: hybrid solution of automated pin set-up (station 2) in combination with gravity-driven deformation (station 5) [Schipper, 2015]

2D situation

To clarify the difficulties, we will now first restrict ourselves to a two-dimensional example. Assume that the principle illustrated in Figure 1 will be elaborated in an imaginary machine with six actuators at a mutual spacing of 180 mm, supporting a flexible mould surface. This flexible mould surface, shown in Figure 3, is deformed from flat to single-curved. In the figure two possible deformations are shown, namely into a circle segment with a radius of 5000 mm and one into a circle segment with 1200 mm radius, respectively.

Assume now, that one wants to manufacture a concrete element with exactly the same shape as the circle segment with the 1200 mm radius shown in the lowest image in Figure 3. For deformation of the mould, the actuator heights need to be adjusted to the correct heights. It is important to notice that the mould surface is not *stretched in-plane*, but only *bent*. Hence, the tips of the actuators remain equi-distant, provided that one measures

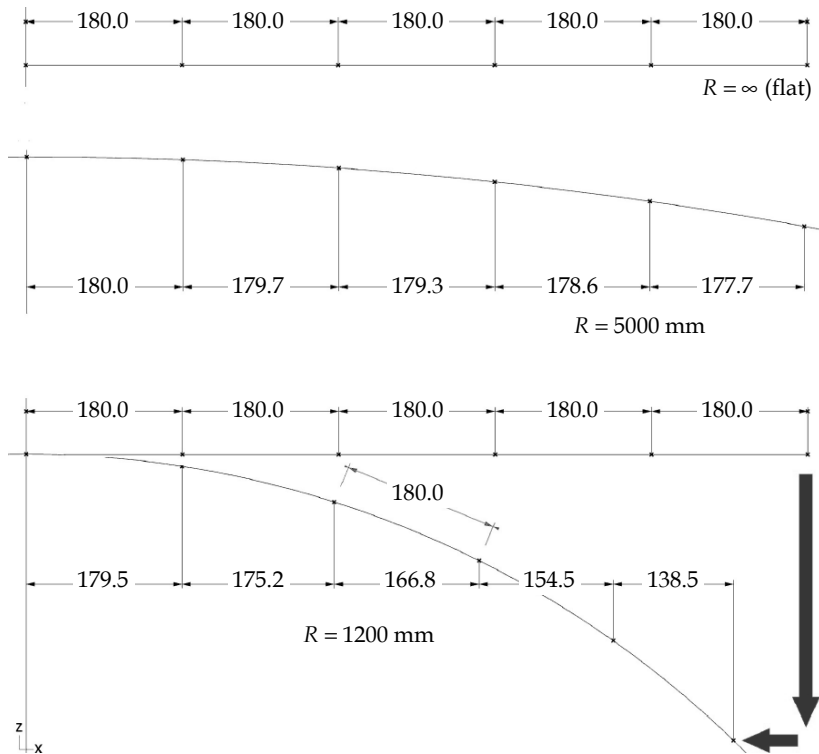

Figure 3: With increasing deformation of the mould, the horizontal displacements of actuator tips become relatively large and non-negligible.

along the mould surface. In the example of Figure 3, a 180 mm spacing was chosen for the actuators, like in the prototype that will be discussed later in this article. As can be seen, the horizontal displacements that accompany the large vertical displacements are not negligible, and need to be taken into account. This requires a smart actuator mechanism, in which the large displacements in both vertical and horizontal direction are accommodated and taken into account, so that the actuator tips, after deformation, will end in exactly those positions that lead to the exact shape of the concrete element. Inclusion of hinges or a flexible actuator could enable these required degrees of freedom.

3D situation

Now that we have examined this simple example in 2D, the three-dimensional situation is easier to explain. In a 3D situation, the mould surface will - like the actuators - need to accommodate relatively large horizontal displacements in *two* directions: it has to stretch or shrink. The Kine-Mould prototype, shown in Figure 4, was especially designed to allow

these large deformations in an accurate manner. The actuators allow horizontal displacements, as visible in the figure. The mould surface uses a specific deformation mechanism that will be discussed in more detail now.

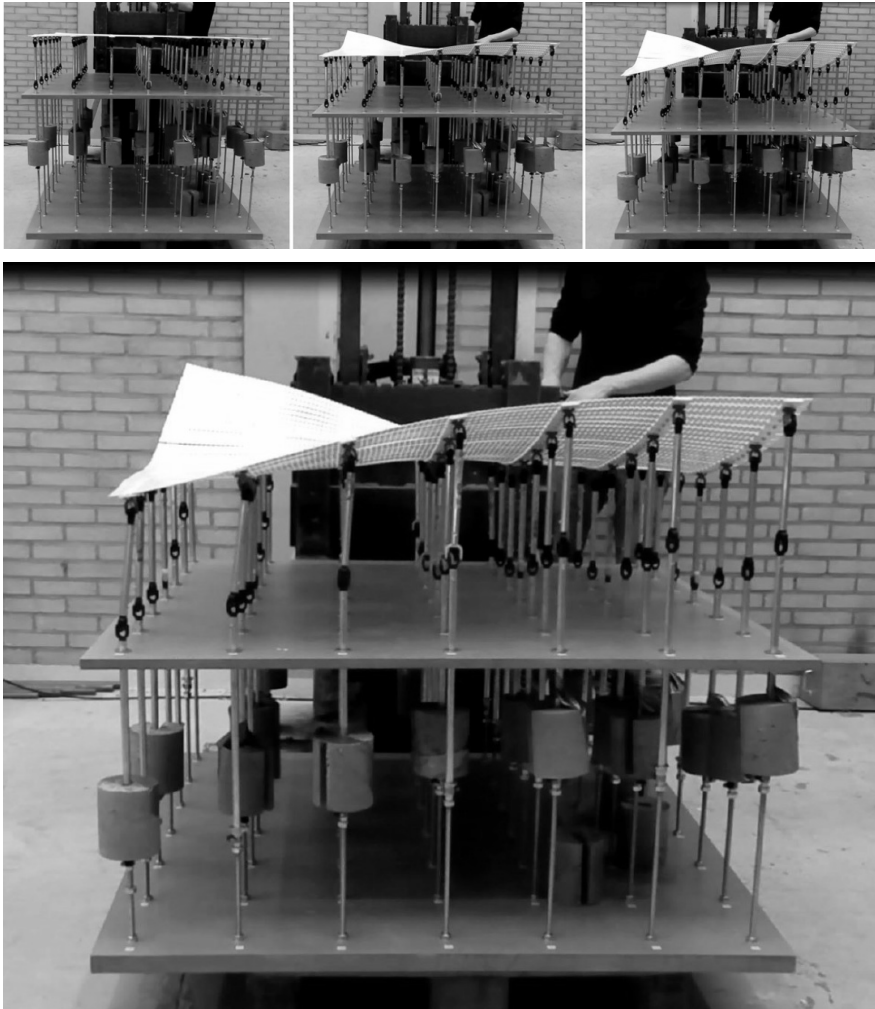

Figure 4: A prototype built in the project Kine-Mould funded by STW (Dutch Technology Foundation). In this prototype the tips of the actuators can sway in one or two directions to allow for the necessary horizontal displacements [Eigenraam and Schipper, 2015; Schipper et al., 2015b]. Here a hyperbolic paraboloid is formed. In the leftmost line of actuators, the varying horizontal displacement is clearly visible.

Kine-Mould projects for STW and 4TU.Bouw Lighthouse

The deformable surface of the first Kine-Mould prototype, shown in Figure 4, consisted of two layers of mutually perpendicularly arranged strips, offering bending stiffness in two directions, but also allowing *shear deformation*. This shear principle was developed according to the ideas set out first by Eigenraam [2013]. A further improvement was done with the prototype shown in Figure 5, developed by TU Eindhoven in the 4TU.Bouw Lighthouse project, also named Kine-Mould. This mould was successfully used to hot-bend glass panels that were arranged into a glass shell-like structure [Schipper et al., 2015a]. The prediction of the kinematics of the Kine-Mould, however, appears to be rather challenging. The following sections will work out this challenge in further detail.

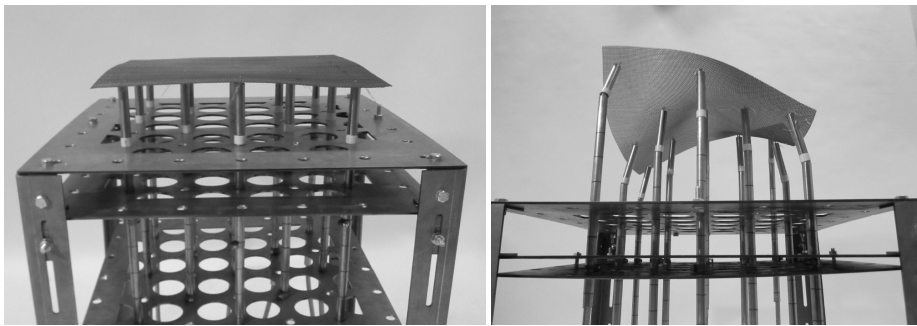

Figure 5: A mould surface from Omnimesh steel mesh. The main feature of the mesh is that it is woven and not welded, allowing the wires to shear undisturbed. This allows the mesh to take many shapes [Schipper et al., 2015a] (images: courtesy of Arno Pronk, TU Eindhoven).

3 Shear deformation

Gauss and Calladine

Gauss [1827] made a study of the mathematical description and physical behaviour of surfaces. The Gaussian curvature is an important local parameter for points on curved surfaces, defined as the product of the principal curvatures κ_1 and κ_2 at the given point, where curvature is defined as $\kappa = 1/R$. The implications of Gauss' work for the design of concrete shells were described in a very clear manner in Calladine [1983] and Calladine [1986]. In Eigenraam and Schipper [2015] the work of Gauss and Calladine was applied to the flexible mould surface: to deform a surface from flat to double-curved, it needs to stretch or shrink in x and/or y -direction, or it needs to shear in xy -direction. The most successful moulds were the ones that made use of the latter form of deformation: shear deformation.

Figure 6 clearly illustrates how this principle is already used in a familiar kitchen utensil. The shear angle appears to be a function of the Gaussian curvature and the area of the curved surface over which this Gaussian curvature applies. Calladine introduced the term *angular defect* with the symbol β as a useful property of deformation.

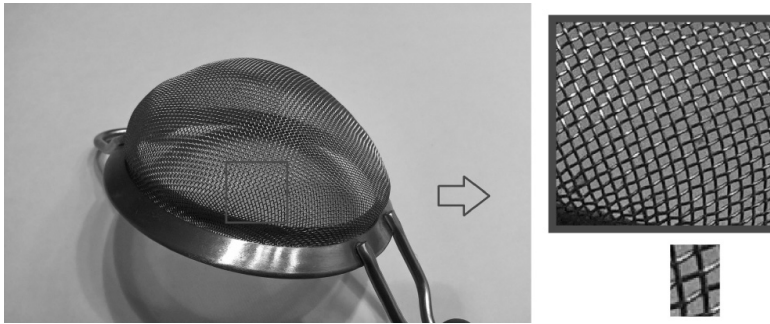

Figure 6: A kitchen sieve clearly shows the principle of shear-deformation: a flat steel mesh can be formed into a double-curved surface, by allowing shear angles between the woven wires of the sieve. Although it cannot be completely ruled out that also stretching of the wires has occurred, shear deformation will result in the required shape with limited force.

Angular defect

The hat-like shape on the left in Figure 7 can be folded from a flat piece of paper (middle), cut in the pattern as shown. The right image shows a representation of the hat surface on a unit sphere: each of the 5 planes in the hat surface has a different normal vector, all 5 normal vectors are scaled to unity length, and then put with their starting vertex on the center vertex of a unity sphere. The dots on the unity sphere in the right image are the ending vertices of the 5 vectors. The area β appears to be equal to the angle β shown in the middle image Calladine [1986]. This angle β was called the *angular defect* by Calladine, and

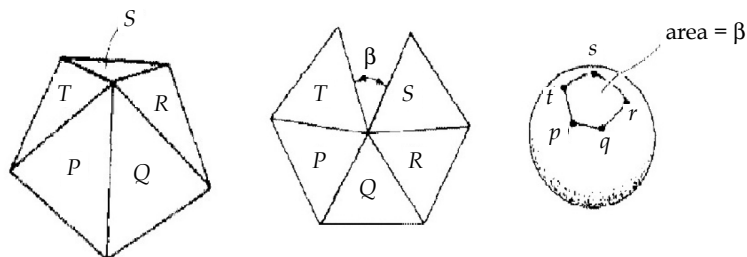

Figure 7: Calladine [1983] described the principle of a Gaussian sphere.

appears to be a varying, but always purely geometrical property of any non-planar surface. As we will see later, it can be used to describe the kinematics of the flexible mould, using shear deformation.

4 Algorithm to locate the actuator tips on a flexible mould surface

Attempt to describe actuator forces is abandoned

In all earlier publications on the Kine-Mould, the authors have focused on describing both deformations *and* actuator forces. This leads to a quite large system of equations with many degrees of freedom, in which the full elastic behaviour of the mould surface needs to be taken into account. Since the system of equations is non-linear due to the large deformations, direct solution linked to a CAD-modeller is not straightforward. In the present article, we will abandon the attempt to describe any forces. This is only possible under the assumption that the deformation does not depend on the elasticity of the mould surface. We believe that, if only shear deformation and bending is possible in the surface of the mould, a good approximation can be found. Comparison between model and measurements in Section 5 will later demonstrate that this assumption is appropriate.

Parametric-associative approach

We will now introduce a parametric-associative algorithm, which was developed to describe the deformation of a mould surface from flat to double-curved, using shear deformation. We will call this the *mapping* algorithm: it maps a one-to-one geometrical relation between the flat and the deformed situation. The algorithm is inspired by the draping-algorithm developed by Bergsma [1995] and applied by Woodington et al. [2015]. Furthermore, a quite comparable method was developed by Toussaint [2007] for determining grids with equal rib lengths for freeform timber grid shells. The present algorithm is used to construct all important coordinates in 3D-space. This is necessary for both the height adjustment of the actuators and the correct positioning of the mould edge. Both are needed for an accurate computer-aided manufacturing (CAM) process. The mapping algorithm was developed in GrassHopper (GH), a plug-in allowing parametric design in the geometric modeller Rhinoceros 3D (together further abbreviated here as Rhino-GH). The advantage of the Rhino-GH environment is the direct interaction between architectural model (CAD) and concrete element manufacturing solutions (CAM).

Step 1: choosing a base grid of actuator distances

A square base grid of $\Delta X \cdot \Delta Y \text{ mm}^2$ is first chosen as the centre lines for the feet of all actuators. In the prototype earlier shown in Figure 4, $\Delta X = \Delta Y = c = 180 \text{ mm}$. c is a user-chosen value, of which the choice is affected by the stiffness of the mould surface and the thickness of the concrete; the stiffer the mould surface, the thinner the concrete and the smaller this grid size, the less deflection the mould will exhibit between the actuator tips (so called 'ponding'). As assumed earlier, we will abandon any attempt to describe stiffness here. For the proper choice of c , a trial-and-error strategy is followed.

Step 2: choosing an origin and orientation in the global coordinate system

As a next step, the concrete panel that will be manufactured is now placed with its centre in the origin of an orthogonal coordinate system x - y - z (Fig. 8a). The centre of the concrete element does not necessarily need to be the centre of gravity, it can basically be any user-chosen centre. This choice, however, will affect the necessary shear deformation, as we will see later. Two perpendicular cutting planes are placed parallel to the vertical z -axis. These planes divide the concrete panel in roughly four 'quarters'. The mechanism of the flexible mould will be designed such, that all actuators that are in these two planes can only rotate *in-plane*. This is an important starting point for the further algorithm. In other words: the swaying of the actuator tips is facilitated by a mechanism that only allows rotation in one direction, according to the prototype shown in Figure 4 on page 357.

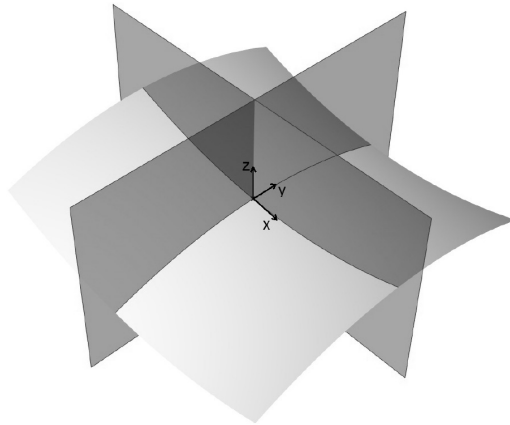

Figure 8a: Perpendicular planes in the x - z plane and y - z plane and an example of a double-curved element that could be manufactured using the flexible mould. Here, the element is only represented as the surface facing the mould. In reality, the element has an offset (thickness).

Step 3: construct position of actuator tips in two perpendicular planes x-z and y-z

By constructing circles with radius c , starting from the origin, the intersections between the curved surface and the two cutting planes can be divided in equal distances c (compare the 180 mm distance measured along the curved line in Figure 3, lower image). This step is illustrated in Figure 8b. It is important to realise that this equi-distant distribution takes into account that *no in-plane elongation* of the mould surface occurs, which is correct.

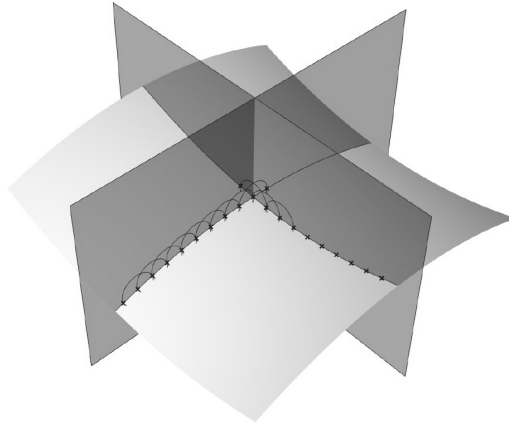

Figure 8b: The first tips of the actuators are constructed by measuring a distance c along the surface in the x-z and y-z plane. The thus constructed points represent the tips of those actuators that are in the x-z and y-z plane.

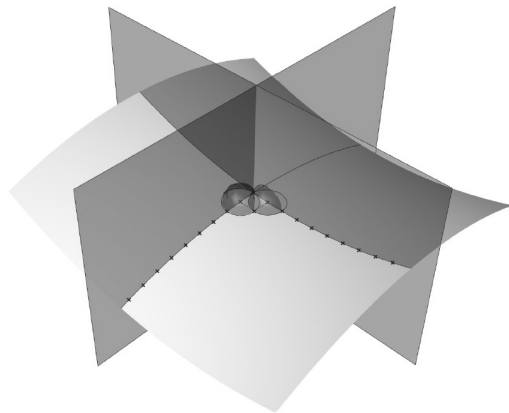

Figure 8c: Then, by drawing two spheres with a radius $R = c$ around the first axis points, the next intersection point with the double-curved mould surface is constructed. This intersection point is connected with the axis points constructed earlier, and the first actuator tip outside of the perpendicular planes is found.

Step 4: construct first actuator tip outside the cutting planes

Now that all actuator tips *in* the cutting plates are found, the actuator tips outside of these planes can be constructed. This is done by constructing two spheres with the earlier found actuator tips as origins (Fig. 8c), both spheres again having a radius c . This radius implies that no elongation (stretching) in-plane of the mould surface is occurring.

Step 5: construct remaining actuator tips

Finally, by repeating step 4 as many times as there are actuator tips, the whole grid of actuator tips on the curved surface can be 'rolled out' or draped (Fig. 8d). By combining two earlier found actuator tips, every time a third one can be found, and so on.

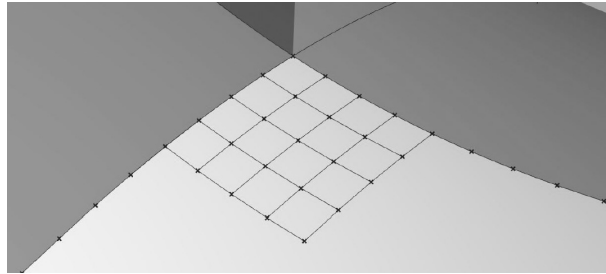

Figure 8d: Consequently, using the same sphere construction method, the other actuator tips are found. The length of all mesh edges is c . All shown points are exactly on the double-curved surface. The method actually is similar to draping a wire mesh over a curved surface.

5 Investigating the resulting shear angles

Introduction: no stretching, only shear

The kitchen sieve in Figure 6 illustrated that the deformation of an (almost) non-stretchable steel mesh into a double curved surface is possible, by the means of shear deformation only. It can be observed that in Figure 8d, the quadrilaterals that were drawn by connecting the actuator tips, have equal rib length c (= no stretching), but do not have 90 degree angles (= shear deformation). Let's now look in more detail at these shear angles and their relation to the curvature of the surface.

Figure 9 shows how the same algorithm was repeated on four sphere-like surfaces, with the sphere radius decreasing stepwise from 5.0 m to 1.2 m. Additionally, the shear angles were measured and plotted, using Rhino-GH. For a sphere radius of 5.0 m, a shear angle

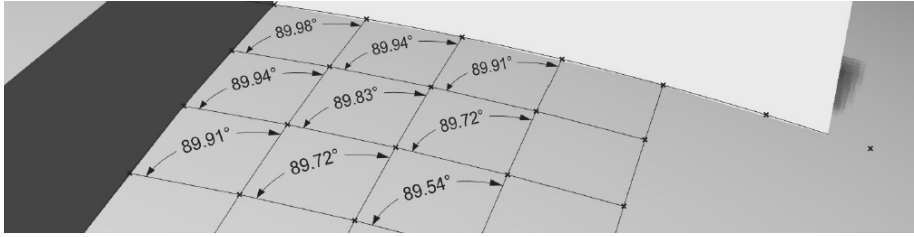

(a) sphere $R = 5.00$ m; angle 89.54°

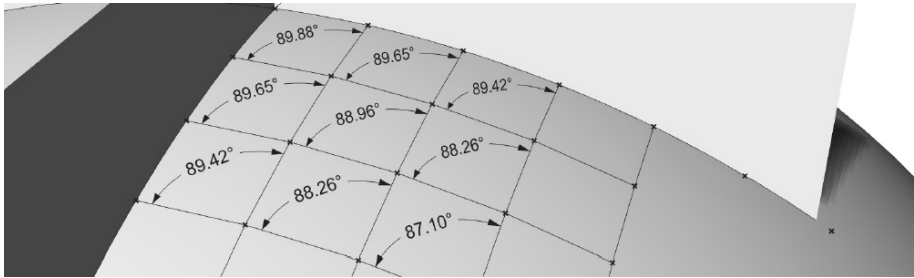

(b) sphere $R = 2.00$ m; angle 87.10°

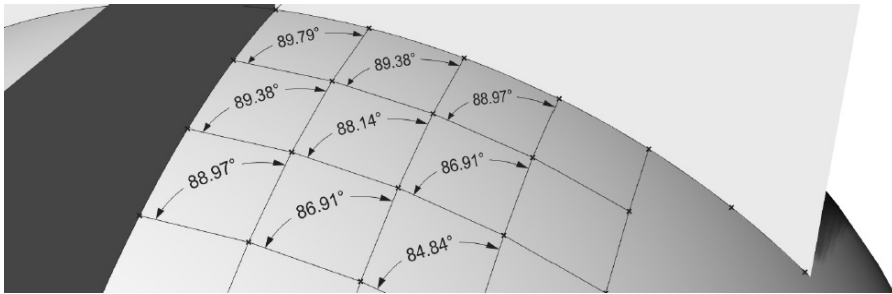

(c) sphere $R = 1.50$ m; angle 84.84°

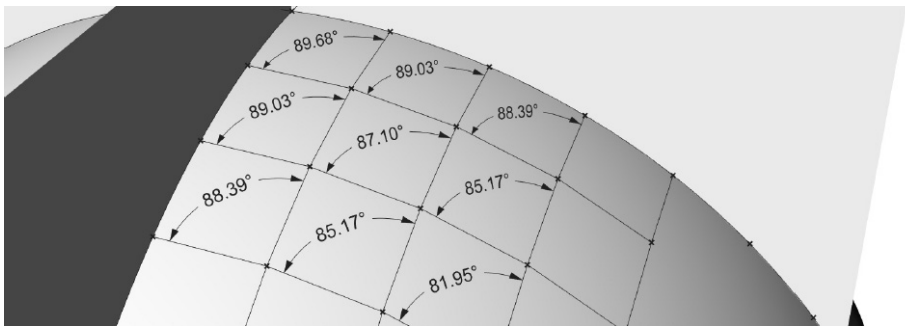

(d) sphere $R = 1.20$ m; angle 81.95°

Figure 9: Choosing a sphere-shaped element as basis for the draping clearly illustrates the shear-effect. A decreasing radius of the sphere results in a sharper shear-angle, here measured over 9 grid cells. Meanwhile, the edge length of the mesh remains c in all four cases.

in the quadrilateral on the third row and the third column of 89.54° was measured (Figure 9a). Repeating the same for a radius of 1.2 m leads to a shear angle of 81.95° for the same quadrilateral. In all four cases, the edge length remains $c = 180$ mm.

Intermediate conclusion on shear deformation

From this exercise, it hopefully becomes clear that, without stretching of the mould surface in x - or y -direction, only using shear deformation, a double-curved surface can be draped with an originally flat mesh. Furthermore there appears to be a relation between the Gaussian curvature and the resulting shear angle.

Comparison between model and prototype measurements

Before investigating this relation in more detail, let's first do a check of the calculated shear angles: the values found with the Rhino-GH model are compared to the shear angles measured in the real prototype of the Kine-Mould. Figure 10 and 11 show this comparison for spheres with a radius of 1.5 and 1.2 m, respectively.

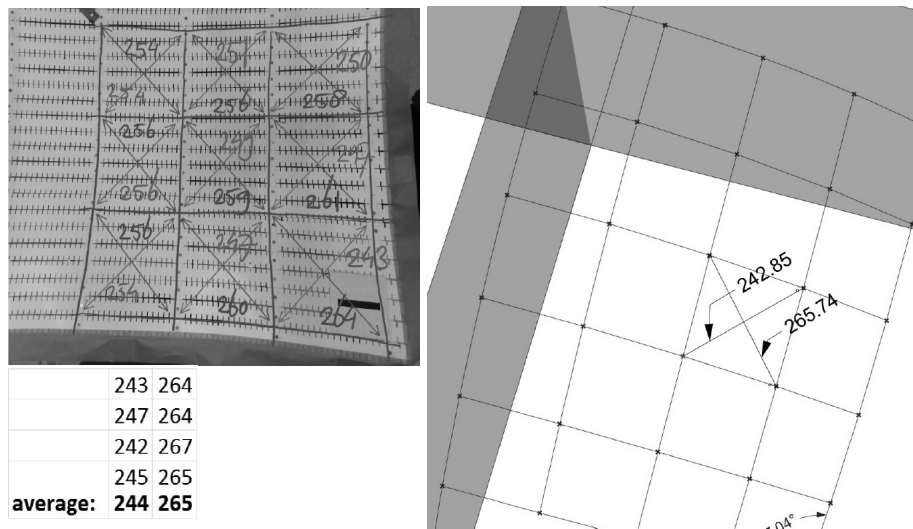

Figure 10: The shear-angle in the Rhino-GH model compared to that in the prototype, $R = 1500$ mm. Good correspondence (error below 1%) is found between the values calculated using the model and the average values determined by measuring the diagonals over four mould corners of the prototype set-up. The angle is calculated from the diagonal lengths as follows:

$$\gamma = 180^\circ - 2 \arctan \frac{l_{\text{long diag}}}{l_{\text{short diag}}} = 180^\circ - 2 \arctan \frac{265.74}{242.85} = 84.84^\circ$$

$$\beta = 12.5 K c^2 \frac{360^\circ}{4\pi} = 12.5 \frac{1}{1.50^2} 0.18^2 \frac{360^\circ}{4\pi} = 5.16^\circ \quad (1)$$

Subsequently, the shear angle $\gamma = 90^\circ - \beta = 84.84^\circ$, which corresponds with the value measured in Rhino-GH, demonstrating that the factor 12.5 was chosen correctly. As can be observed, the shear angle, draping a mesh over a sphere, increases when further removed from x - and y -axis.

In Table 1 below, the coefficients to calculate the shear angle are shown. It becomes clear that the shear angle increases rapidly when moving away from the origin (in case $K = \text{constant}$). Example: for a sphere with a radius $R = 2.5 \text{ m}$ and a grid size $c = 0.18 \text{ m}$ the shear angle in cell ($i = 10, j = 10$) the coefficient

$$n = 0.5(2i - 1)(2j - 1) = 2ij - i - j + \frac{1}{2} = 180.5 \quad (2)$$

and

$$\beta = 180.5 \frac{1}{2.5^2} 0.18^2 \frac{360^\circ}{4\pi} = 26.8^\circ \quad (3)$$

then $\gamma = 90^\circ - \beta = 63.2^\circ$.

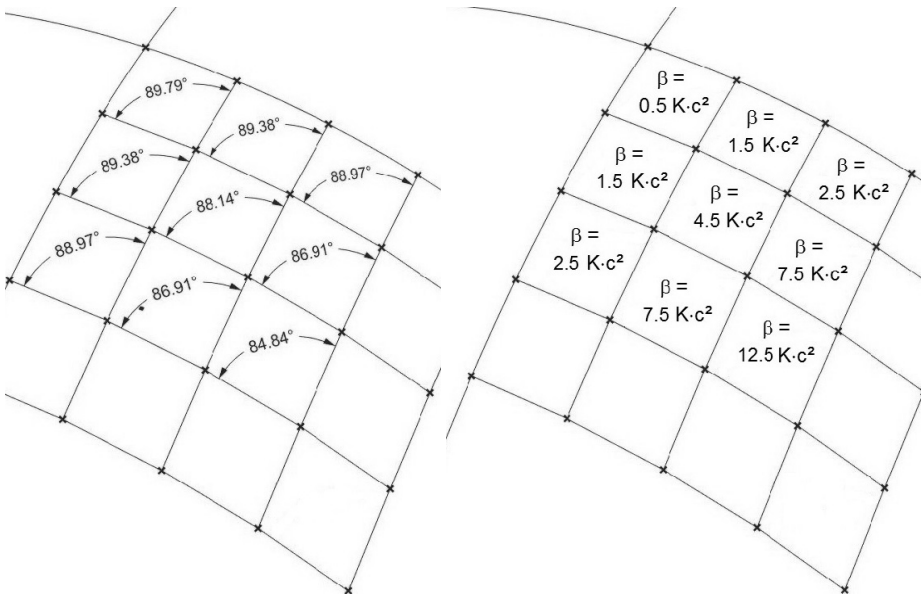

Figure 12: Angular defect β according to Calladine, left measured in the Rhino-GH model, right expressed as factor of the Gaussian curvature K and the grid size c ($R = 1.5 \text{ m}$ and $c = 0.18 \text{ m}$).

Table 1: Coefficients n of the calculated shear-angle $\beta = nKc^2$ in the specified grid cell, with $n = 2ij - i - j + \frac{1}{2}$

	$i = 1$	2	3	4	5	6	7	8	9	10
$j = 1$	0.5									
2	1.5	4.5								
3	2.5	7.5	12.5					symmetrical		
4	3.5	10.5	17.5	24.5				$n = 2ij - i - j + \frac{1}{2}$		
5	4.5	13.5	22.5	31.5	40.5					
6	5.5	16.5	27.5	38.5	49.5	60.5				
7	6.5	19.5	32.5	45.5	58.5	71.5	84.5			
8	7.5	22.5	37.5	52.5	67.5	82.5	97.5	112.5		
9	8.5	25.5	42.5	59.5	76.5	93.5	110.5	127.5	144.5	
10	9.5	28.5	47.5	66.5	85.5	104.5	123.5	142.5	161.5	180.5

The equation for the coefficients can be understood if the definition of Calladine [1986], page 187 is followed:

$$\text{Gaussian curvature} = \frac{\text{angular defect at a vertex}}{\text{area associated with the vertex}} \quad (4)$$

where Calladine uses a triangulated version of a sphere. In a similar manner, the term $2ij$ in the equation for n represents the area associated with the cells of our mesh; the terms $-i$, $-j$ and $+\frac{1}{2}$ represent a correction due to the prevention of shear in the two central cutting planes.

What if K is not constant?

For surfaces with varying Gaussian curvature K , such as freeform shells, the shear angle will increase or decrease, according to the local Gaussian curvature and the shear angle 'received' from adjacent cells closer to the x - y -axis. Let's look at an example of such a freeform surface. Figure 13 shows a part of the inner concrete cladding of a tunnel section of the Crossrail project in London, that is currently under construction. The tunnel consists of two single-curved (circular) tubes, each with different radius, that have been connected by a smooth surface ('fillet') at the intersection of both tubes. The fillet surface is clearly double-curved, however, the shear of the mesh for the selected concrete panel is surprisingly limited. This is the result of the fact that some parts are convex and others concave, resulting in increase and decrease of the shear angle, respectively. For a sphere,

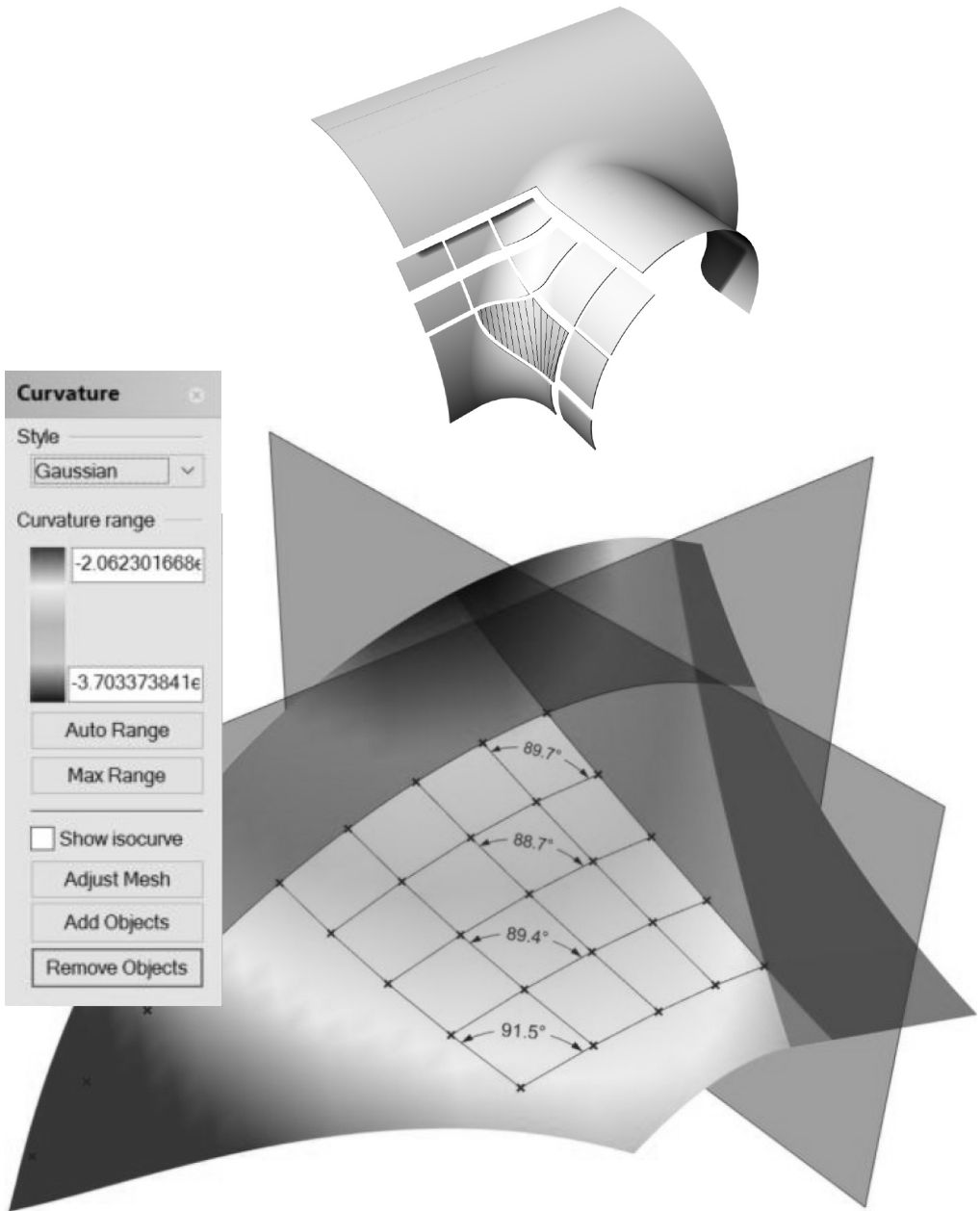

Figure 13: Top: exploded view of double-curved concrete elements applied in the London Crossrail Farringdon station interior cladding. Bottom: the Gaussian curvature of the hatched element is analysed ($-3.70 < K < -2.06 \text{ mm}^{-2}$) and the mesh is constructed. The shear angles at the diagonal stay close to 90° (= no shear) and vary only between 88.7° and 91.5° . (Colour figures are available at www.heronjournal.nl)

we were able to exactly determine the coefficients for shear in each cell. It is however less transparent how to capture the shear angle mathematically for surfaces with varying curvature. This implies that the use of the parametric-associative approach, as presented here, can be helpful to find the optimal position of the concrete element in the flexible mould. The optimisation consist of translation and rotation of the element until the minimal amount of shear is obtained. Why would such an optimisation be needed? A minimum of shear assures the most accurate deformation of the mould, since by observation of the various prototypes it was found that large shear angles generally are accompanied with inaccuracy and local buckling effects of the strips that make up the mould surface [Janssen, 2011; Eigenraam, 2013]. Also, if a steel mesh is used instead of strips, minimisation of shear angles is desirable, since locking of the mesh is occurring if shear values become to large [Bergsma, 1995]. A further advantage of using the Rhino-GH approach is that the edges of the mould can be localised with the same algorithm, as we will see in the next section.

Further development of Rhino-GH script

Before moving on to the important topic of edge positioning, the status of the script implementation needs to be discussed: at this moment, the script that was developed in Rhino-GH is not particularly stable for processing the wide range of freeform shapes that occur in a typical building geometry. This lack of stability is the result of the fact that the Grasshopper script is based on finding intersection points between curves and surfaces or spheres and surfaces. This sometimes leads to multiple answers that need to be assessed, after which the proper one has to be selected. Therefore, a more robust implementation is still needed. The findings above, however, in our opinion, demonstrated a proof of concept and accuracy for all situations in which the mesh was correctly constructed.

6 Suggestion for an algorithm to find the mould edges on a flexible mould surface

One of the advantages of the flexible mould method, is that the concrete element is cast in *flat position*, and that deformation into the curved shape is carried out in a later stage. This greatly simplifies the casting process, since a self-compacting and self-levelling concrete can be applied in an open, single-sided mould. The use of such concrete leads to a much smoother concrete surface texture than the use of stiffer mixtures that would be needed if the concrete is applied *after* deformation, by plastering or spraying the concrete.

However, the choice for this procedure implies that the position of the mould edges also needs to be determined in the *flat* situation (see Figure 14). Whereas in the finally targeted curved surface, all coordinates can be easily found through measuring in 3D space in the CAD-program, finding the right coordinates is less easy for the flat situation. This problem was already addressed in the subsection "Geometrical aspects of edge positioning" in [Schipper, 2015]. There, it was proposed to develop a projection or 'mapping' algorithm for this.

Figure 15 illustrates how in the flat situation the mould edge could be positioned correctly. This algorithm yet has to be developed, the present illustration is not output from Rhino-GH, but is meant as documentation of the following idea. First, the intersection points

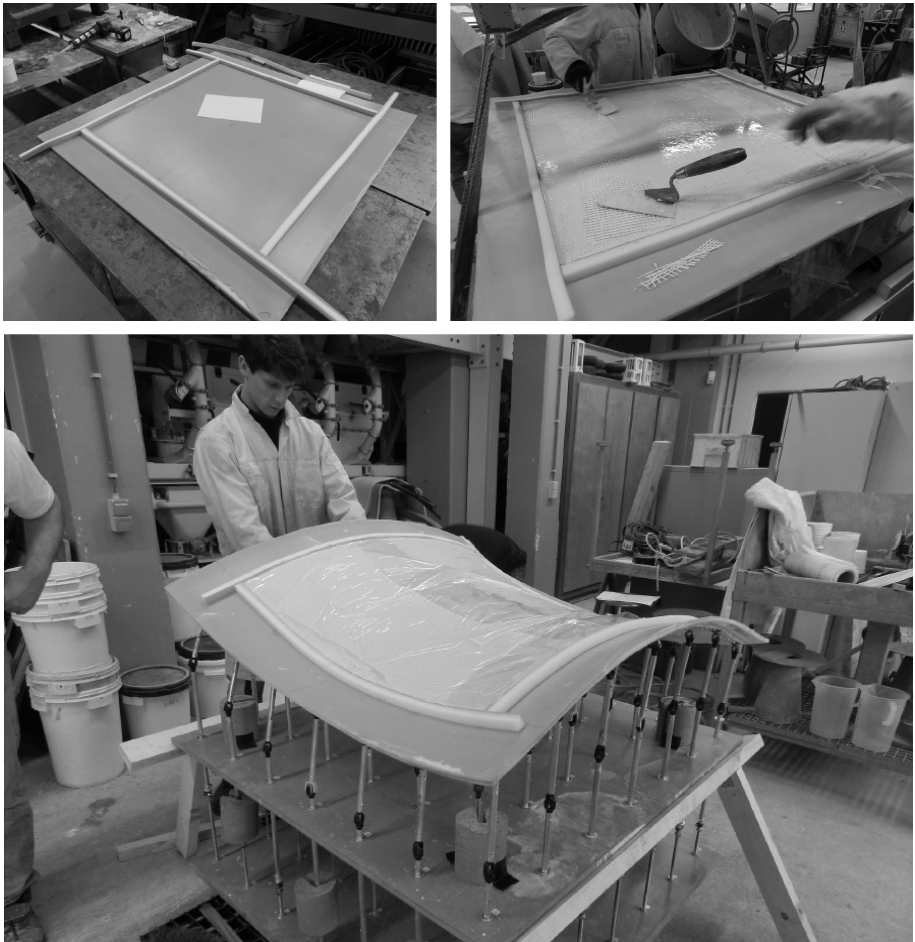

Figure 14: Process of edge positioning, casting and deformation

between the mesh and the mould edges need to be identified and registered. Since the intersection points can be referenced to the mesh in both curved and flat situation, then also the position in the flat situation becomes clear. Further work is needed on implementation of this algorithm, but we feel that it follows an unambiguous procedure that properly takes into account the shear deformation.

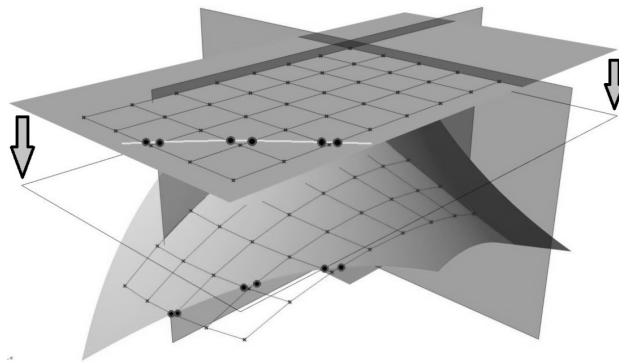

Figure 15: By finding the closest point between the earlier constructed mesh and the original edge curve, the mapping of the edge curve from double-curved to flat can be obtained, allowing the projection of the edge in the flat situation. Here a freeform panel, taken from the Crossrail Farringdon station interior cladding (Fig. 13), is shown. The fat dots are on the edge contour of the mould, and can be used both in flat and deformed situation.

7 Conclusions

A parametric-associative approach was presented for modelling the deformation of a flexible mould. This flexible mould can be applied for precasting freeform concrete shell elements. The deformation principle used to transform from flat to double-curved is *shear deformation*. The following conclusions are drawn:

- To abandon any attempt calculating actuator forces at the same time as shape transformations, simplifies the problem to a large extent.
- The draping algorithm that was presented by Bergsma [1995] inspired the present algorithm in Rhino-GH. The parametric-associative algorithm has the advantage that it opens the possibility for real-time visual interaction and modification.
- The shear angles calculated with the Rhino-GH algorithm show good correspondence (within 2%) with those measured in two configurations in a real mould prototype.

- For a regular double-curved geometry, such as a sphere, the shear angles can be calculated accurately using the Gaussian curvature, the mesh size and a matrix of predefined coefficients.
- Also for non-regular (freeform) curved surfaces, the presented algorithm opens the possibility to calculate and minimize the shear angle.
- By registering the intersection points between the mesh and the element edges in the deformed situation, it is possible to determine where these element edges should be positioned in the flat situation of the mould. This part, though, was not implemented yet.

8 Further research and outlook

In this article a number of topics were not discussed: the exact construction of the actuator heights from the actuator tip, the fluidity of the concrete in relation to the mould slope, optimisation options in the Rhino-GH environment and ways to process large numbers of concrete elements in an efficient manner. These topics are subject for further research. As discussed, the edge positioning needs implementation. We expect that, after an initial investment in accurate software and equipment at industrial strength and scale, the presented draping algorithm and mould method can be used for economically producing large projects in precast concrete cladding or structural concrete shell elements, but also for other construction materials.

Acknowledgments

This work was carried out with the help of a Valorisation Grant provided by Dutch Technology Foundation STW and a 3TU.Bouw Lighthouse Grant.

References

- Bergsma, O. (1995). *Three Dimensional Simulation of Fabric Draping*. PhD thesis, Delft University of Technology.
- Bösiger, H. (2011). The building of Isler shells. *IASS Journal*, 52-3(169):161-169.
- Calladine, C. R. (1983). *Theory of shell structures*. Cambridge University Press.
- Calladine, C. R. (1986). *Gaussian Curvature and Shell Structures*, pages 179-196. Clarendon Press, Oxford.

- Eigenraam, P. (2013). Flexible mould for production of double-curved concrete elements. Master's thesis, Delft University of Technology.
- Eigenraam, P. and Schipper, H. (2015). Concepts and prototypes for flexible moulds for production of double curved elements. In Coenders, J., Borgart, A., and Pronk, A., editors, *Proceedings of the International Society Of Flexible Formwork (ISOFF) Symposium, Amsterdam*. KIVI.
- Gauss, K. F. (1827). *General Investigations of Curved Surfaces of 1827 and 1825*. Project Gutenberg translation 2011.
- Janssen, B. (2011). Double curved precast load bearing concrete elements. Master's thesis, Delft University of Technology.
- Moiralis, G. (2013). Analysis and design of free form precast planks - investigate the possibility of applying the flexible mould method in free form floors. Master's thesis, Delft University of Technology.
- Mungan, I. and Abel, J., editors (2011). *Fifty Years of Progress for Shell and Spatial Structures: In Celebration of the 50th Anniversary Jubilee of the IASS (1959-2009)*. International Association for Shell and Spatial Structures.
- Schipper, H., Eigenraam, P., Soru, M., Grunewald, S., and Pronk, A. (2015a). 4TU.Federation Lighthouse project Kine-Mould, material efficiency using a flexible kinematic mould system. <https://www.4tu.nl/bouw/en/lighthouse2014/kine-mould/>.
- Schipper, H. R. (2015). *Double-curved precast concrete elements - Research into technical viability of the flexible mould method*. PhD thesis, Delft University of Technology.
- Schipper, H. R., Eigenraam, P., Grünewald, S., Soru, M., Nap, P., Van Overveld, B., and Vermeulen, J. (2015b). Kine-mould: Manufacturing technology for curved architectural elements in concrete. In Coenders, J., Borgart, A., and Pronk, A., editors, *Proceedings of the International Society Of Flexible Formwork (ISOFF) Symposium, Amsterdam*. KIVI.
- Toussaint, M. (2007). A design tool for timber gridshells - the development of a grid generation tool. Master's thesis, Delft University of Technology.
- Witterholt, S. (2016). The application of prefabricated double-curved concrete elements for the project green planet. Master's thesis, Delft University of Technology.
- Woodington, W., Bergsma, O., and Schipper, H. (2015). Shear-deforming textile reinforced concrete for the construction of double-curved elements. In Coenders, J., Borgart, A., and Pronk, A., editors, *Proceedings of the International Association for Shell and Spatial Structures (IASS) Symposium, Amsterdam*. KIVI.

