

Effect of long-term thermal cycling and moisture on heated Fibre Metal Laminates and glass-fibre epoxy composites

Hagenbeek, Michiel; Sinke, Jos

DOI

[10.1016/j.compstruct.2018.11.068](https://doi.org/10.1016/j.compstruct.2018.11.068)

Publication date

2019

Document Version

Accepted author manuscript

Published in

Composite Structures

Citation (APA)

Hagenbeek, M., & Sinke, J. (2019). Effect of long-term thermal cycling and moisture on heated Fibre Metal Laminates and glass-fibre epoxy composites. *Composite Structures*, 210, 500-508.
<https://doi.org/10.1016/j.compstruct.2018.11.068>

Important note

To cite this publication, please use the final published version (if applicable).
Please check the document version above.

Copyright

Other than for strictly personal use, it is not permitted to download, forward or distribute the text or part of it, without the consent of the author(s) and/or copyright holder(s), unless the work is under an open content license such as Creative Commons.

Takedown policy

Please contact us and provide details if you believe this document breaches copyrights.
We will remove access to the work immediately and investigate your claim.

Effect of long-term thermal cycling and moisture on heated Fibre Metal Laminates and glass-fibre epoxy composites

Michiel Hagenbeek*, Jos Sinke

*Structural Integrity & Composites, Faculty of Aerospace Engineering, Delft University of
Technology, Kluyverweg 1, 2629 HS Delft, The Netherlands*

Abstract

Heated GLARE, a Fibre Metal Laminate with an integrated heater element, has a promising potential as de- or anti-icing system in aircraft structures. To investigate the long-term durability of heated GLARE previously reported thermal cycling tests up to 12000 cycles are extended up to 144000 cycles and moisture conditioning is included. Similar testing up to 72000 cycles is performed on FM906 glass-fibre epoxy laminates with an integrated heater element to study the influence of the aluminium layers in GLARE.

In all test results the initial decrease in interlaminar shear values from 0 to about 10000 thermal cycles is followed by a recovery phase and a resumed decline after roughly 60000 cycles. The decrease in ILSS is expected to be caused by internal stress relief which is counteracted by the positive effect of physical ageing due to elevated temperature exposure. Thermal cycling of conditioned samples generally resulted in slightly larger decreases in interlaminar shear strength for both heated GLARE and heated FM906 glass-fibre epoxy laminates.

Keywords: Glass-fibre epoxy composite, heated GLARE, thermal cycling, moisture, interlaminar shear strength

*Corresponding author

Email address: m.hagenbeek@tudelft.nl (Michiel Hagenbeek)

URL: www.tudelft.nl/ae (Michiel Hagenbeek)

1. Introduction

Heated GLARE, a Fibre Metal Laminate with an integrated heater element, has a promising potential as de- or anti-icing system in aircraft structures. The effect of thermal cycling on internal heated GLARE has been explored up to 12000 cycles in previous research [1, 2]. To investigate the long-term durability of heated GLARE beyond 12000 cycles the thermal cycling tests have been extended up to 144000 cycles and moisture conditioning has been included.

A maximum decrease in interlaminar shear strength (ILSS) of -7.8% was previously found for internal heated GLARE after 12000 cycles in the temperature range from -25 to 95 °C [1]. For internal heated cross-ply FM906 glass-fibre epoxy laminates a similar decrease of -7.3% was found after 12000 cycles in a smaller temperature range from -25 to 50 °C [2]. After an initial drop (5.6% after 4kC), expected to be caused by internal stress relief, the GLARE samples cycled between 25 and 50 °C show increased ILSS values (up to +2.6% after 12000 cycles). The GLARE samples cycled between 25 and 72.5 °C did not show a drop but a steady increase in ILSS (+5.7% after 12000 cycles) as a result of physical aging [2].

For application of heated GLARE as deicing system in aircraft structures the number of cycles is expected to be even higher than the mentioned 12000 cycles. It is not only determined by the number of flights in which the deicing system is turned on, but as well by the pulsed heating as discussed in reported research [2]. Assuming the de-icing system is used in 10% of a 90000 flight service life for a regional aircraft results in 9000 heating events. When a heating event consists of 1 cycle per 3 minutes and lasts 30 minutes a total number of 90000 thermal cycles is experienced in addition to thermal loadings due to regular flight conditions in this application. In addition, moisture might accumulate in the material over the years. The aluminium outer layers of GLARE however shield off the moisture uptake by the glass-fibre epoxy layers in GLARE. In laboratory tests Botelho reported a 0.15% weight gain in GLARE after 6 weeks of exposure at 80°C and 90% relative humidity [4, 5]. Based on outdoor exposure

tests Beumler predicted a maximum 0.2% moisture uptake for Glare after 30 years exposure in the tropics [3].

However, even for GLARE 4A-4/3-0.3 samples conditioned to only 0.41% moisture Zhong reported an ultimate strength decrease of -45.4% without identifiable structural defects in the microstructure [6]. Majerski found up to -15% decrease in tensile strength for R-glass epoxy and AS7 carbon fibre epoxy based fibre metal laminates with a 0.1 to 0.2% moisture content [7]. Borgonje and Ypma reported decreases of maximum -15% on GLARE properties due a 0.4% moisture content [8, 9]. The durability of the material under these conditions therefore needs to be assessed.

Gkikas found -50 to -60% reduction in ILSS of completely saturated carbon-fibre epoxy after 100 thermal cycles (-30 to +30 °C) [10]. In contrast, the ILSS was practically unaffected after exposure to thermal cycling only. An overview of twelve different studies on thermal cycling (up to 300 cycles) and conditioning of FRP is given by Sousa in which maximum ILSS reductions of -29.3% are reported [11]. Li showed that 1000 thermal cycles between -65 to +135 °C hardly changed the fatigue crack growth in a novel fibre metal laminate based on an aluminium-lithium alloy and S4-glass polysulfone-epoxy prepreg [12]. Park found -9 to -18% reduction in ILSS for unconditioned GLARE 5-7/6-0.4 specimens after 1500 thermal cycles between 25 to 125 °C [13]. For glass-fibre epoxy [0]₄₀ a slightly smaller -8 to -13% decrease in ILSS was found. According to Park this difference is explained by internal stresses in the GLARE specimens that do not exist in the UD glass-fibre epoxy specimens. After thermal cycling a thick aluminium FML, GLARE2/1-1.6, up to 2000 cycles between -50 and +80 °C Da Costa did not find a reduction in tensile or interlaminar shear strength [14].

These results from literature indicate that moisture and temperatures beyond the material T_g play an important role in the material degradation due to thermal cycling. The larger temperature range of Da Costa (-50 to 80 °C) compared to Park (25 to 125 °C) seems less important, since no strength reduction was found by Da Costa. Calculations show indeed that internal stresses in GLARE do not rise significantly at low temperatures compared to room

temperature, taking into account the change in thermal expansion coefficient and stiffness with temperature [2]. Around Tg there is significant drop in stiffness. Cycling from room temperature beyond Tg will therefore give a maximum change in internal stresses.

In the current study both the effect of extended thermal cycling and the effect of moisture on heated GLARE are investigated. Long-term thermal cycling tests up to 144000 cycles have been performed on GLARE with an integrated heater element using a specifically designed thermal cycling setup [1, 15]. A first test series was performed up to 72000 cycles in the -20 to 80 °C temperature range on both dry and conditioned samples with 0.2% moisture uptake.

A second series of tests was performed up to 144000 cycles in the -20 to 50 °C temperature range on dry samples. Similar testing was performed up to 72000 cycles for FM906 glass-fibre epoxy laminates with an integrated heater element in the -20 to 80 °C temperature range on both dry and conditioned samples with 0.3% moisture uptake. FM906 glass-fibre prepreg epoxy is used in heated GLARE [19] and by testing the pure composite the influence of the aluminium layers can be investigated. The extended number of thermal cycles are expected to be in the range of a potential aircraft deicing system.

2. Heated GLARE

2.1. The heated GLARE lay-up

In Figure 1 both a heated GLARE laminate and a heated cross-ply composite laminate are depicted as used in the current research. The cross-ply composite laminate is build-up from unidirectional (UD) glass-fibre epoxy layers only, whereas in GLARE these layers are stacked together with aluminium sheets [16]. Heating is introduced by embedding copper heater elements between the UD glass-fibre epoxy layers. The influence of the aluminium layers on the thermal cycling behaviour can thus be examined by comparing the test results for GLARE with the results for the cross-ply composite laminate. By integrating heating in the certified (structural) aircraft material GLARE the material

can potentially be applied for de-/anti-icing of aircraft leading edges [16].

FM906 glass-fibre epoxy prepreg is used in the heated laminates. This prepreg has a higher allowable service temperature of 120°C compared to the FM94 prepreg used for conventional GLARE. The higher allowable service temperature results from the higher glass transition ($T_g=135^\circ\text{C}$ vs. 103°C) and curing (180°C vs. 120°C) temperatures [17]. Both heated GLARE and conventional GLARE are autoclave cured in one hour at 6 bars of pressure [18]. Since the stiffness of the FM94 significantly decreases at temperatures beyond 70°C , FM906 glass-fibre prepreg epoxy is used in heated GLARE [19]. The vacuum, pressure and temperature set points which are used for manufacturing of heated GLARE can be found in already reported research [2].

2.2. Leading edge loading conditions

The major loading conditions of heated leading edges are depicted in Figure 2. Mechanical stresses in the material develop due to the aerodynamic and gravitational loading of the wing. Due to the different thermal expansion coefficients of the heated GLARE constituents (aluminium, epoxy, glass-fibre, copper) thermal stresses in the material develop during and after manufacturing. These thermal stresses change due to temperature changes during ascents and descents (once per flight) [18] and due to internal heating in case of anti- and de-icing (several times per flight) [20, 21, 22]. Therefore, both the mechanical and the thermal loading have a cyclic nature and can lead amongst others to fatigue damage [23, 24]. Moreover, the elevated temperatures in case of anti- and de-icing are expected to cause physical ageing of the epoxy [1, 2, 25]. Damage on the leading edge can also be caused by impact, for example due to bird strike, and more gradually due to moisture ingress during the lifetime of the structure. Although the aluminium outer layer shields the glass-fibre epoxy layers in case of GLARE, moisture ingress can take place along the edges and bore holes [26]. The total moisture ingress is however expected to be limited to 0.2% as shown by Beumler [3].

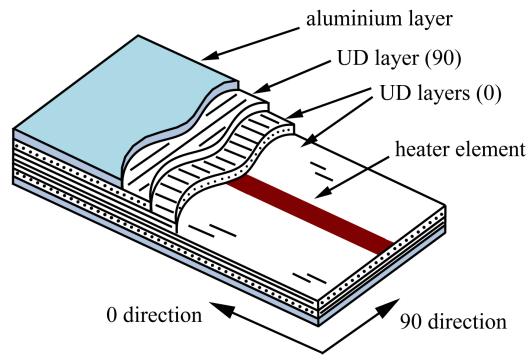

(a)

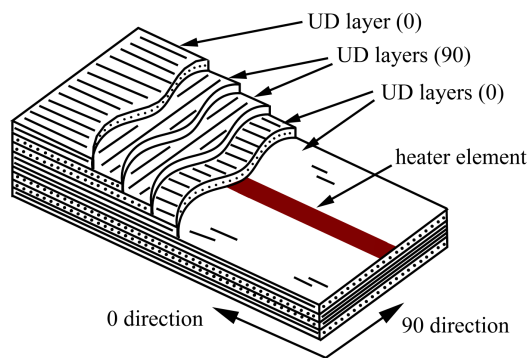

(b)

Figure 1: Schematic lay-up: (a) heated GLARE and (b) heated cross-ply composite laminate.

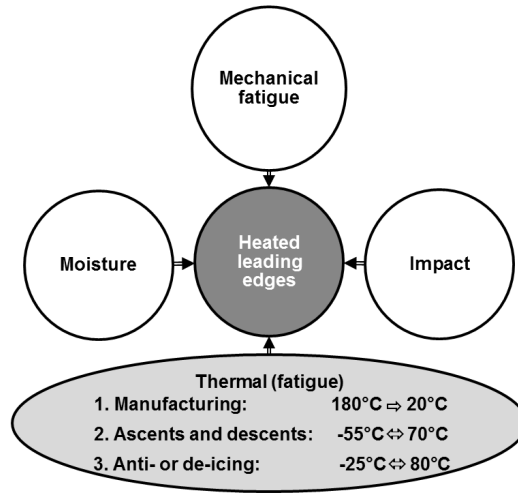

Figure 2: Major loading conditions of leading edges made of heated GLARE.

120 3. Experimental procedures

3.1. Thermal cycling setup

A specifically designed thermal cycling system was used to perform the thermal cycling tests. The electrical system uses heater elements inside the material for internal heating and Peltier elements for external cooling on both sides of the sample. This way of cycling corresponds with the intended use as anti-/de-icing device [16]. The system can also be used for both external heating and cooling with the Peltier elements by changing the direction of the current [27]. Thus, with the same setup both conventional GLARE and heated GLARE can be thermally cycled. The thermal cycling setup is shown in Figure 3. In previous research a detailed description of the thermal cycling system has been reported [1, 15].

The thermal cycling is computer controlled using embedded thermocouples and switching from heating to cooling and vice versa when predefined sample temperatures are reached. Temperature range and profile can thus easily be changed by adapting the electrical heating and cooling power. The minimum sample temperature can be further reduced by placing the whole thermal cycling

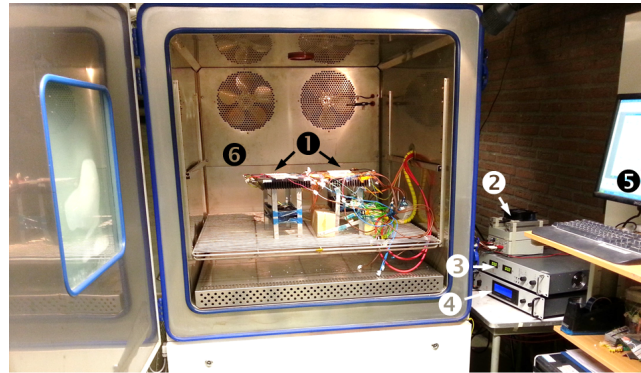

- | | |
|------------------------------------|-------------------|
| ❶ Thermal cycling core | ❷ Power supply 2 |
| ❸ Box with relay (Peltier control) | ❸ Computer |
| ❹ Power supply 1 | ❹ Climate chamber |

(a)

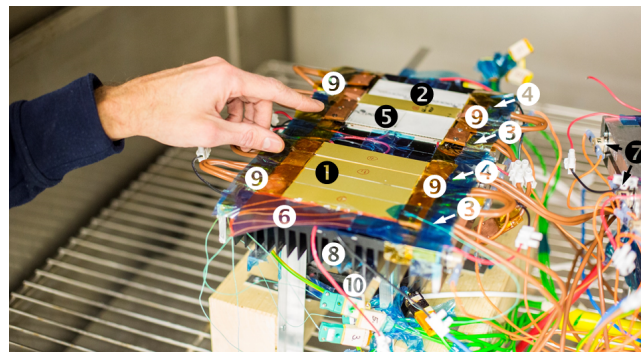

- | | |
|--------------------------------|----------------------------|
| ❶ Sample series 1 (4 in total) | ❶ Embedded thermocouples |
| ❷ Sample series 2 (1 shown) | ❷ Thermal safety switches |
| ❸ Electrical input | ❸ Heat sink |
| ❹ Electrical output | ❹ Copper sample connectors |
| ❺ Peltier elements | ❺ Ventilator |

(b)

Figure 3: Thermal cycling machine in the climate chamber (a) overview and (b) detail.

setup into a climate chamber at low temperature. By using Peltier elements the sample is not exposed to cooling liquids and related effects on material composition or moisture content are thus avoided.

140 *3.2. Thermal cycling samples and conditioning*

Forty-nine samples were investigated in this study. The specimens with the number 0 in their abbreviation were not thermal cycled and used as a reference, all other samples were thermal cycled. All samples were internal heated using the embedded heater element and indicated by the letter H in all the abbreviations. The samples with the abbreviations HGE0 to HGE6 consists
145 of FM906 glass-fibre epoxy with $[90/0/0/90]_{2s}$ layup. The samples with the abbreviations HGL0 to HGL6, HGL10 to HGL23 and HGL30 to HGL36 indicate a heated GLARE 5-2/1-0.3 layup. This layup is comprised of two 0.3 mm thick aluminium layers and four glass fibre-epoxy layers with fibre orientations of
150 $[0/90/90/0]$. All samples indicated with an additional M in the abbreviation were conditioned prior to thermal cycling.

Two different sample configurations are used in the current thermal cycling study and shown in Figure 4. Both configurations have embedded heater elements and are internally heated through resistance heating. Sample configuration I shown in Figure 4a has 0.12mm thick and 2.5mm wide copper heater
155 element embedded at the edge. Both heated FM906 glass-fibre epoxy composites and heated GLARE 5-2/1-0.3 samples have been used for thermal cycling with this configuration. Thermal cycling was performed without and with prior conditioning to moisture (indicated by the additional M in the designation).
160 This configuration allows for easy microscopic inspection and comparison of the interfaces before and after testing. Sample configuration II shown in Figure 4b has a much thinner, 0.03mm thickness, and 5.0mm wide copper heater element embedded at the centre and is only used for thermal cycling of heated GLARE 5-2/1-0.3. The loading conditions of the thermal cycled samples with
165 configuration I and II are depicted in Table 1 and Table 2 respectively.

All samples have a width of 25mm, which allows for simultaneous cycling

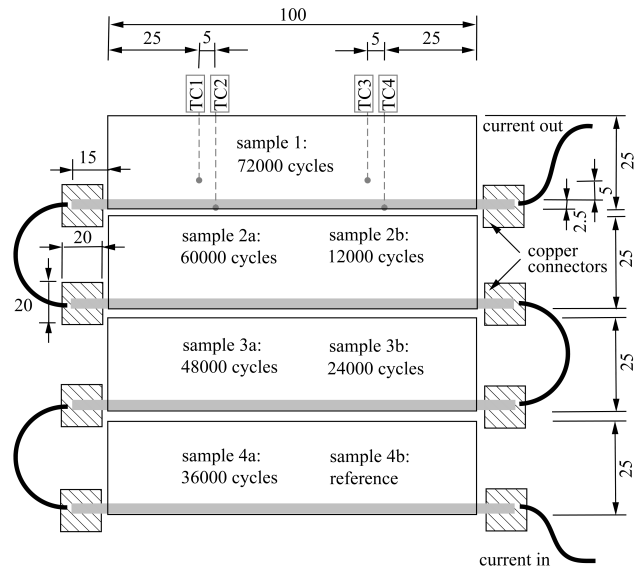

(a) Configuration I

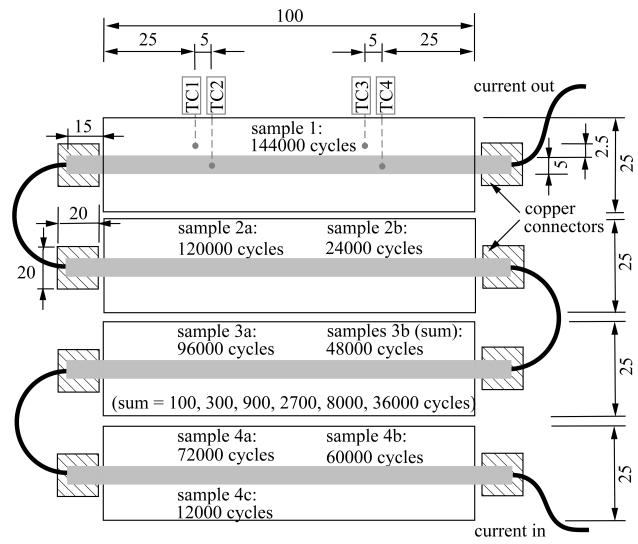

(b) Configuration II

Figure 4: Sample dimensions and arrangement: (a) 0.12mm thick and 2.5mm wide heater element at the edge, (b) 0.03mm thick and 5.0mm wide heater element at the centre.

of multiple samples. On position 2, 3 and 4 a combination of samples is used with the same total number of cycles as the continuously cycled sample 1. By replacing samples at conveniently chosen intervals, as indicated in Figure 4, the overall cycling time can be significantly reduced compared to sequential testing and an economic use of the thermal cycling machine is achieved. Four thermocouples were embedded in the samples to monitor and control the thermal loading. Two thermocouples (TC2, TC4) were embedded on top of the heater element with a single glass-fibre epoxy layer in between. The two other thermocouples (TC1, TC3) were embedded at a distance of 5mm and 2.5mm to the heater element for sample configuration I and II respectively. The in-plane positions of the thermocouples are depicted in Figure 4.

For both the heated glass-fibre epoxy and the heated GLARE samples the heater element is positioned at the mid-plane in the 90 degree direction. The heater element is thereby stacked between two 90 degree glass-fibre epoxy layers with the orientation along the fibre direction. The stiffness difference between the copper heater element and the glass-fibre epoxy layer is thereby reduced as much as possible in this direction.

For the FM906 glass-fibre epoxy samples the conditioning was performed by exposing the samples for 4 weeks to 85% relative humidity and 55°C temperature in a climate chamber and a weight gain of 0.3% was reached. For the GLARE samples a weight gain around 0.2% was obtained by submerging the samples in water of 60°C for about 5 weeks.

3.3. Thermal cyclic fatigue testing

Three different temperature ranges were chosen in the thermal cycling tests; -25 to 95°C, -20 to 80°C and -20 to 50°C. In the first two test series both heated FM906 glass-fibre epoxy and the heated GLARE 5-2/1-0.3 with sample configuration I, shown in Figure 4a, were tested. The typical thermal cycles are shown in Figure 5 (a) and Figure 5 (b) for FM906 glass-fibre epoxy and GLARE 5-2/1-0.3 respectively. The heated glass-fibre epoxy samples HGE1 to HGE6 were cycled as received and samples HGE1M to HGE6M after conditioning to 0.3%

Table 1: Samples without and with moisture (M) and configuration I (Figure 4a): Nomenclature (nom), materials, thermal loading conditions and number of cycles (noc).

| nom | T_{min} [°C] | T_{max} [°C] | Moisture [%] | noc [-] |
|--------------|-------------------|-------------------|-----------------|------------|
| Heated GFRP | | | | |
| HGE0(M) | na | na | (0.3%) | 0 |
| HGE1(M) | -25 | 95 | (0.3%) | 12000 |
| HGE2(M) | -25 | 95 | (0.3%) | 24000 |
| HGE3(M) | -25 | 95 | (0.3%) | 36000 |
| HGE4(M) | -25 | 95 | (0.3%) | 48000 |
| HGE5(M) | -25 | 95 | (0.3%) | 60000 |
| HGE6(M) | -25 | 95 | (0.3%) | 72000 |
| Heated GLARE | | | | |
| HGL0(M) | na | na | (0.2%) | 0 |
| HGL1(M) | -20 | 80 | (0.2%) | 12000 |
| HGL2(M) | -20 | 80 | (0.2%) | 24000 |
| HGL3(M) | -20 | 80 | (0.2%) | 36000 |
| HGL4(M) | -20 | 80 | (0.2%) | 48000 |
| HGL5(M) | -20 | 80 | (0.2%) | 60000 |
| HGL6(M) | -20 | 80 | (0.2%) | 72000 |

Table 2: Samples with configuration II (Figure 4b): Nomenclature (nom), materials, thermal loading conditions and number of cycles (noc).

| nom | T_{min} [°C] | T_{max} [°C] | Moisture [%] | noc [-] |
|--------------|-------------------|-------------------|-----------------|------------|
| Heated GLARE | | | | |
| HGL10 | na | na | - | 0 |
| HGL11 | -20 | 50 | - | 100 |
| HGL12 | -20 | 50 | - | 300 |
| HGL13 | -20 | 50 | - | 900 |
| HGL14 | -20 | 50 | - | 2700 |
| HGL15 | -20 | 50 | - | 8000 |
| HGL16 | -20 | 50 | - | 12000 |
| HGL17 | -20 | 50 | - | 24000 |
| HGL18 | -20 | 50 | - | 36000 |
| HGL19 | -20 | 50 | - | 60000 |
| HGL20 | -20 | 50 | - | 72000 |
| HGL21 | -20 | 50 | - | 96000 |
| HGL22 | -20 | 50 | - | 120000 |
| HGL23 | -20 | 50 | - | 144000 |
| HGL30 | na | na | - | 0 |
| HGL31 | -20 | 80 | - | 12000 |
| HGL32 | -20 | 80 | - | 24000 |
| HGL33 | -20 | 80 | - | 36000 |
| HGL34 | -20 | 80 | - | 48000 |
| HGL35 | -20 | 80 | - | 60000 |
| HGL36 | -20 | 80 | - | 72000 |

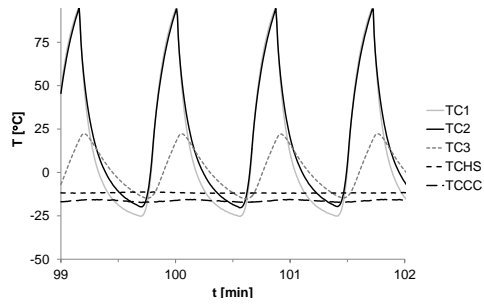

(a)

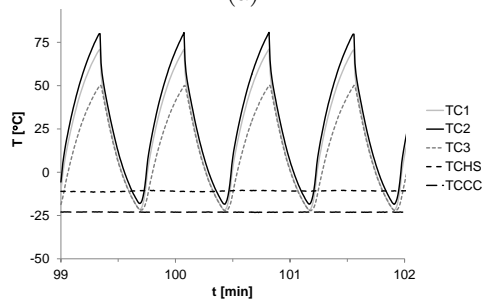

(b)

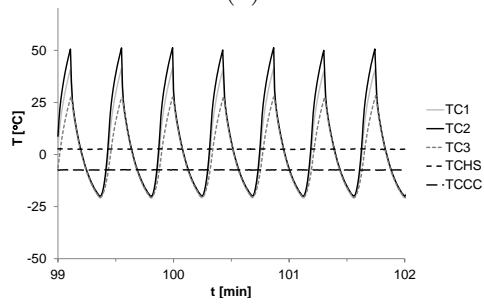

(c)

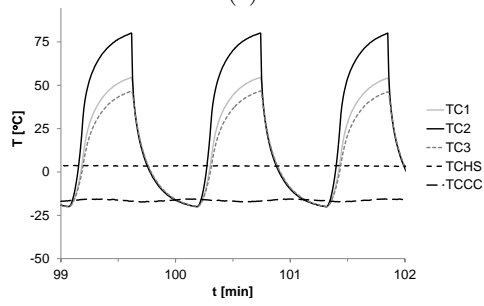

(d)

Figure 5: Typical thermal cycles for heated FM906 glass-fibre epoxy (a) HGE1(M)-HGE6(M), and heated GLARE (b) HGL1(M)-HGL6(M), (c) HGL11-HGL23 and (d) HGL31-HGL36 (cf. Table 1.)

Table 3: Total exposure time in hours of specimens after 12000 thermal cycles (cf. Figure 5).

| Temp. range [°C] | HGE1 [h] | HGL1 [h] | HGL16 [h] | HGL31 [h] |
|----------------------|-------------|-------------|--------------|--------------|
| -30 to -20 | 43.3 | 0.0 | 0.0 | 0.0 |
| -20 to -10 | 30.0 | 21.7 | 28.3 | 71.7 |
| -10 to 0 | 16.7 | 18.3 | 15.0 | 26.7 |
| 0 to 10 | 11.7 | 13.3 | 11.7 | 16.7 |
| 10 to 20 | 10.0 | 13.3 | 10.0 | 10.0 |
| 20 to 30 | 6.7 | 11.7 | 6.7 | 6.7 |
| 30 to 40 | 6.7 | 13.3 | 7.5 | 6.7 |
| 40 to 50 | 6.7 | 13.3 | 9.2 | 8.3 |
| 50 to 60 | 6.7 | 15.0 | 0.0 | 10.6 |
| 60 to 70 | 8.3 | 12.5 | 0.0 | 20.6 |
| 70 to 80 | 8.3 | 15.0 | 0.0 | 46.7 |
| 80 to 90 | 10.0 | 0.0 | 0.0 | 0.0 |
| 90 to 100 | 8.3 | 0.0 | 0.0 | 0.0 |
| Σ | 173.3 | 147.5 | 88.3 | 224.6 |
| Min temp [°C] | -25 | -20 | -20 | -20 |
| Max temp [°C] | 95 | 80 | 50 | 80 |
| Cycle time [s] | 52.0 | 44.3 | 26.5 | 67.4 |
| Max cycles [kC] | 72 | 72 | 144 | 72 |
| Total time [days] | 43.3 | 36.9 | 44.2 | 56.2 |

moisture in a temperature range from -25 to 95°C up to 72000 cycles. Similar cycling was performed on heated GLARE samples HGL1 to HGL6 as received and samples HGL1M to HGL6M after conditioning to around 0.2% moisture, 200 in a temperature range from -20 to 80°C.

Two additional test series were performed on heated GLARE with sample configuration II as indicated in Figure 4b. The first additional tests on samples HGL11 to HGL23 were performed in the -20 to 50°C temperature range and ran up to 144000 cycles. A significant lower maximum temperature of 50°C and 205 relatively high input current, and thus a short cycle time of 26.5s, was chosen to minimise the positive effect of physical ageing on the epoxy. At the same time interval at elevated temperature the residual stresses remain high in the -20 to 50° temperature range, whereas in the -25 to 95°C or -20 to 80°C range the residual stresses show more decrease. A second series of tests on samples 210 HGL31 to HGL36 were performed in the -20 to 80°C temperature range up to 72000 cycles. The cycle time in this case is 67.4s and thereby much longer than in the -20 to 50° range. The typical thermal cycles are shown in Figure 5 (c) and Figure 5 (d) for GLARE 5-2/1-0.3 cycled in the -20 to 50°C and the -20 to 80°C temperature range respectively.

215 In Table 3 the total exposure time in hours after 12000 thermal cycles is given for all four test series and for each 10°C segment. The cycle time, minimum and maximum temperature, maximum number of cycles, and total cycling time are given as well. From this table it can be seen that heated GLARE sample configuration II (HGL31) was three times longer exposed above 70°C 220 than sample configuration I (HGL1) with the same temperature range but a different cycle shape and cycle time cf. Figure 5 (b) and (d).

Previously reported thermal cycling tests on internal heated GLARE 5-2/1-0.3 and FM906 glass-fibre epoxy ran up to 12000 cycles [1, 2]. Extended thermal cycling tests up to 36000 cycles on FM906 glass-fibre epoxy were only performed 225 by external heating and showed an increase in interlaminar shear strength due to physical ageing. The current tests run up to 72000 with sample configuration I and up to 144000 with sample configuration II. These thermal cycles numbers

are in the range of the estimated total number of 90000 thermal cycles for a potential deicing system during the aircraft service life.

230 3.4. Interlaminar shear strength testing

Interlaminar shear strength (ILSS) tests were performed in threefold on all samples listed in Table 1 and Table 2 according to ASTM standard D2344 [28]. The mean values have been determined for each set of data and are given together with the scatter (absolute minimum and maximum values) in the resulting graphs. The specimens have a width of 4 mm and a length of 20 mm. The
235 ILSS tests were conducted on a 25 kN Zwick test machine with a test speed of 1 mm/min. Correct failure modes were obtained in all tests.

Heated FM906 glass-fibre epoxy and heated GLARE 5-2/1-0.3 samples with configuration I, as shown in Figure 4a and Table 1, were thermal cycled up to
240 72000 cycles with and without prior conditioning to moisture. For some samples the copper connection failed as a result of the high currents used in the thermal cycling tests and the designated number of cycles was not reached.

Figure 6 shows the ILSS results for the heated FM906 glass-fibre epoxy specimens HGE1 to HGE6 thermal cycled between -25 and 95°C . Figure 7
245 gives the ILSS results for specimens HGE1M to HGE6M that were thermal cycled between -25 and 95°C after conditioning up to 0.3% moisture content. In Figure 8 the relative ILSS values, i.e. in comparison to the (non-cycled and non-conditioned) reference, are given for both the conditioned and non-conditioned glass-fibre epoxy specimens as a function of the number of cycles. In Figure 9 the ILSS results are given for the heated GLARE 5-2/1-0.3 HGL1
250 to HGL6 thermal cycled between -20 and 80°C and Figure 10 shows the ILSS results for thermal cycled specimens HGL1M to HGL6M with 0.2% moisture content. For both the conditioned and non-conditioned GLARE specimens the relative ILSS values as a function of the number of cycles can be compared in
255 Figure 11.

Two additional thermal cycling test series on heated GLARE were performed with sample configuration II as indicated in Figure 4b and Table 2. The ILSS

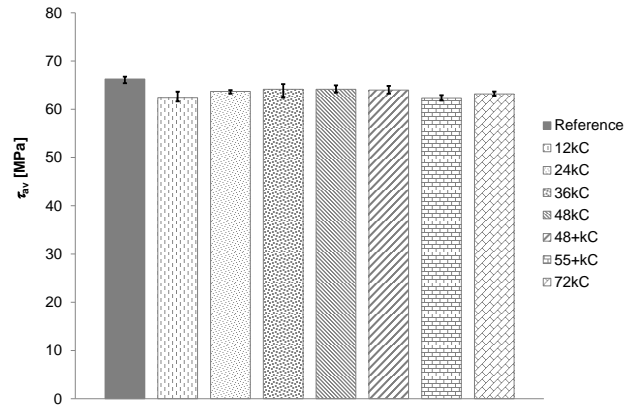

Figure 6: Absolute ILSS values for heated glass-fibre epoxy specimens HGE1 to HGE6 thermal cycled between -25 and 95 °C (cf. Table 1).

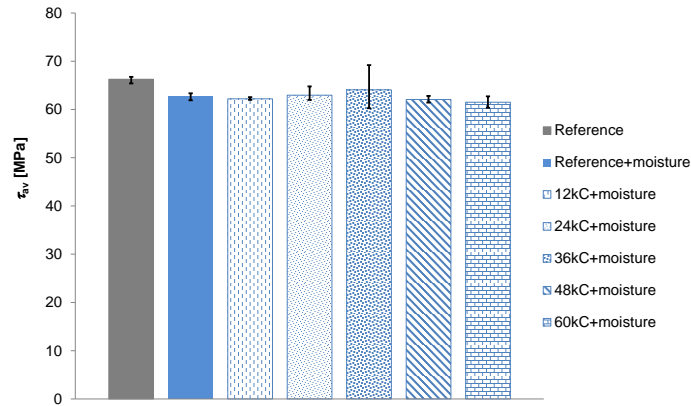

Figure 7: Absolute ILSS values for heated glass-fibre epoxy specimens HGE1M to HGE6M thermal cycled between -25 and 95 °C after conditioning to 0.3% moisture content (cf. Table 1).

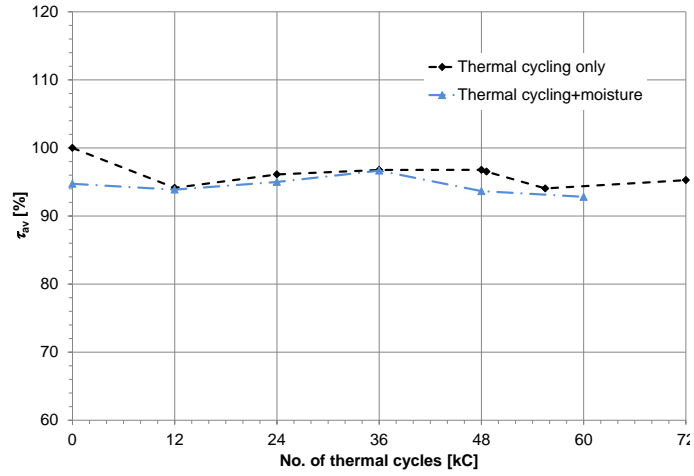

Figure 8: Relative ILSS values for heated glass-fibre epoxy specimens HGE1(M) to HGE6(M) thermal cycled between -25 and 95 °C with and without prior conditioning to 0.3% moisture content (cf. Table 1).

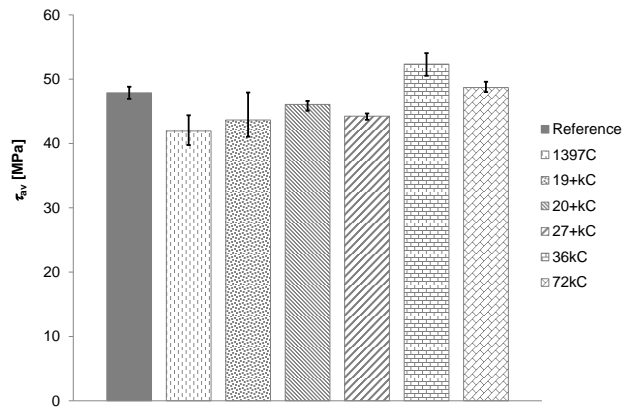

Figure 9: Absolute ILSS values for heated GLARE 5-2/1-0.3 specimens HGL1 to HGL6 thermal cycled between -20 and 80 °C (cf. Table 1).

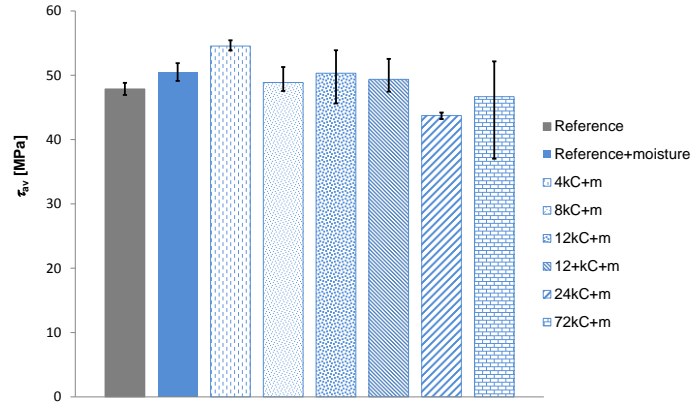

Figure 10: Absolute ILSS values for heated GLARE 5-2/1-0.3 specimens HGL1M to HGL6M thermal cycled between -20 and 80 °C (cf. Table 1).

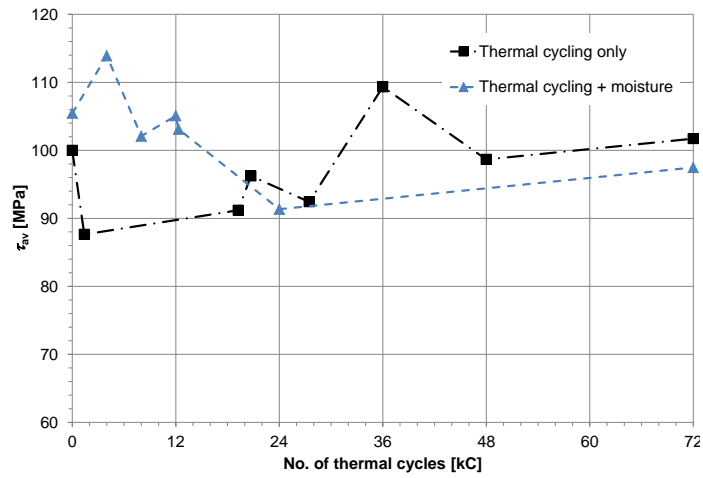

Figure 11: Relative ILSS values for heated GLARE 5-2/1-0.3 specimens HGL1(M) to HGL6(M) thermal cycled between -20 and 80 °C with and without prior conditioning to 0.3% moisture content (cf. Table 1).

test results for heated GLARE 5-2/1-0.3 specimens HGL10 to HGL23 thermal
cycled up to 144000 cycles between -20 and 50 °C are given in Figure 12. Fig-
260 ure 13 shows the ILSS results for heated GLARE 5-2/1-0.3 specimens HGL31
to HGL36 thermal cycled up to 72000 cycles between -20 and 80 °C. In these
tests again some copper connection failed and the designated number of cycles
were not always reached. In Figure 14 the relative ILSS values for both thermal
cycling temperature ranges, -20 to 50 °C and -20 to 80 °C, are depicted in the
265 same graph as a function of the number of cycles.

4. Results and discussion

Both heated FM906 glass-fibre epoxy composites and heated GLARE 5-2/1-
0.3 samples with configuration I have been thermal cycled up to 72000 cycles.
This configuration, shown in Figure 4a, has a 0.12mm thick and 2.5mm wide
270 copper heater element embedded at the edge. Microscopic inspection and com-
parison of the interfaces before and after thermal cycling did not reveal any
damage in the glass-fibre epoxy or the copper-epoxy interface due to moisture
conditioning and thermal cycling, in line with the findings of Zhong [6]. How-
ever, a color change is found in both the glass-fibre epoxy and the copper, which
275 is expected to be caused by corrosion of the copper heater element. The images
before and after 60000 cycles are shown in Figure 15 as an example and besides
a color change (from yellowish to more greenish for the glass-fibre epoxy) do
not show damage.

The interlaminar shear strength (ILSS) results after thermal cycling of heated
280 FM906 glass-fibre epoxy between -25 and 95°C show a -5.9% decrease in strength
after 12000 cycles compared to the non-cycled reference (see Figure 8). This
initial drop in strength is followed by a recovery phase up to 48000 cycles. The
decrease in strength due to thermal cycling has been mentioned by several au-
thors, but the strength recovery after extended thermal cycling has not been
285 reported in the literature due to the limited number of performed thermal cycles
(maximum 2000 cycles) [10, 11, 13, 14]. The strength recovery is expected to be

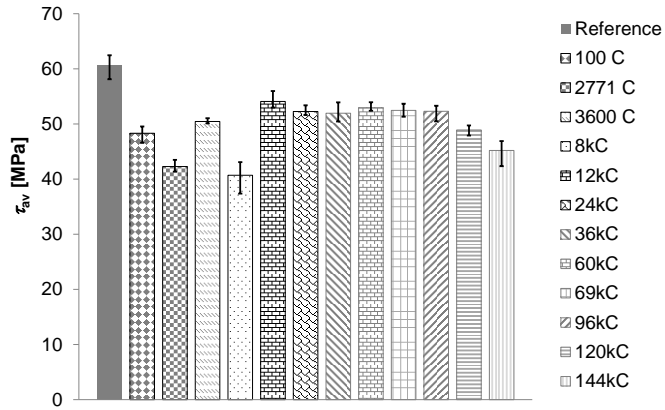

Figure 12: Absolute ILSS values for heated GLARE 5-2/1-0.3 specimens HGL10 to HGL23 thermal cycled between -20 and 50 °C (cf. Table 2).

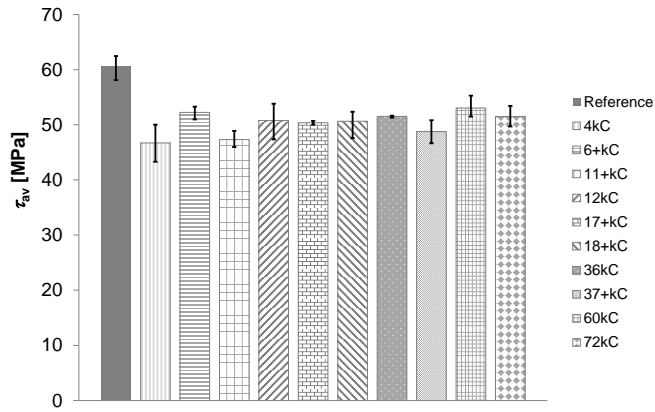

Figure 13: Absolute ILSS values for heated GLARE 5-2/1-0.3 specimens HGL31 to HGL36 thermal cycled between -20 and 80 °C (cf. Table 2).

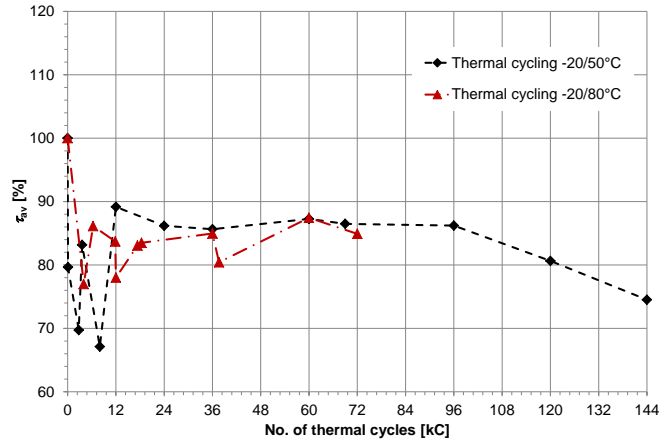

Figure 14: Combined ILSS graph for heated GLARE 5-2/1-0.3 specimens thermal cycled between -20 to 50 °C and -20 to 80 °C in comparison with the reference (cf. Table 1).

caused by physical ageing, which is confirmed by previously reported thermal cycling and ageing test results [2]. The strength at 55000 cycles is the lowest ILSS value found (-6.0%). A similar trend is found for samples with 0.3% moisture content as can be seen in Figure 8 as well. The presence of moisture only, without thermal cycling and without observable damage in the microstructure, gives a -5.3% decrease in the ILSS value. The decrease in ILSS due to moisture is assumed to be caused by plasticization of the epoxy and subsequent internal stress relief. All samples with 0.3% moisture show lower ILSS values after thermal cycling than samples without moisture. Generally, the scatter in the ILSS results is found to be larger for samples with moisture than samples without moisture as well. A maximum decrease of -7.2% in ILSS due to moisture and thermal cycling is found at 60000 cycles. This is in sharp contrast to the -50% to -60% reduction in ILSS found by Gkikas for completely saturated carbon fibre epoxy after 100 thermal cycles (-30 to +30 °C) [10]. Both the limited 0.3% moisture content and the positive effect of ageing in the extended thermal cycling are expected to play an important role in our results.

Heated GLARE 5-2/1-0.3, thermal cycled between -20 and 80 °C, shows a decrease in ILSS of -12.4% after 4000 cycles. This initial drop is followed by

305 a recovery phase with ILSS values reaching +9.3% and +1.7% compared to
the non-cycled reference after 36000 cycles and 72000 cycles respectively, see
Figure 11. Conditioning to 0.2% moisture content gives a direct +5.5% increase
in ILSS, in contrast to a decrease in ILSS found in the literature [6, 8, 9], and
an even further increase up to +13.9% after 4000 thermal cycles. This initial
310 increase in ILSS might be explained by the conditioning method in which the
samples are submerged in 60 °C water. This elevated temperature could have
a positive influence on the glass-fibre epoxy stiffness. The effect of moisture is
also limited to the edges as the ILSS specimens are cut from the centre of the
25mm wide thermal cycling samples. Minor thickness changes in the order of 1%
315 were detected after moisture conditioning. The local swelling and plasticizing
at the edges of the ILSS specimens could postpone failure as well. After 24000
cycles the maximum decrease in ILSS of -8.7% is found, as can be seen in
Figure 11. This is much less than the -17 to -32% decrease found by Park for
fully saturated GLARE 5-7/6-0.4 specimens after 1500 thermal cycles between
320 25 to 125 °C [13]. The moisture content thus has a large influence on the results
and for realistic testing the moisture level should be carefully selected.

Extended thermal cycling up to 144000 cycles was performed on heated
GLARE 5-2/1-0.3 with sample configuration II. This configuration, shown in
Figure 4b, has a much thinner, 0.03mm thickness, and 5.0mm wide copper
325 heater element embedded at the centre. The ILSS results after thermal cycling
of heated GLARE 5-2/1-0.3 between -20 and 50°C show a -32.9% decrease in
strength after 8000 cycles compared to the non-cycled reference (see Figure 14).
Right beside the heater element a maximum decrease in ILSS of only -10.2%
is found after thermal cycling. The larger decrease at the heater element is
330 confirmed by results found in previously reported research [1, 2] and expected
to be caused by internal stress relief at the copper-epoxy interface. The positive
effect of physical ageing due to elevated temperature exposure does not yet play
an important role for these low number of cycles and low maximum temperature.
Between 8000 cycles and 60000 cycles there is a recovery of the interlaminar
335 shear strength up to -12.7% followed by a further decline to -25.5% after 144000



(a)

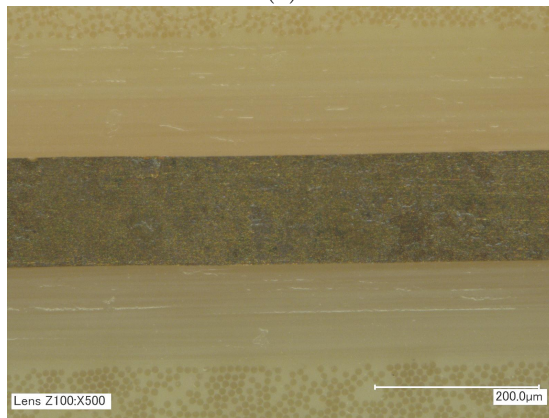

(b)

Figure 15: Optical microscope image of a heated GLARE sample (a) before conditioning and cycling and (b) after conditioning and 60000 thermal cycles. 500 times magnification.

cycles.

For heated GLARE 5-2/1-0.3 with sample configuration II and thermal cycled between -20 and 80°C an initial drop in ILSS of -23% is found at 4000 cycles. In this case the decrease in ILSS is less pronounced than in the -20 and 50°C temperature range. This initial drop is followed by a recovery phase with ILSS values reaching -12.6% and -15.1% compared to the non-cycled reference after 60000 cycles and 72000 cycles respectively, see Figure 14.

5. Conclusions

Heated GLARE 5-2/1-0.3 and heated FM906 glass-fibre epoxy have been thermal cycled in three different temperature ranges; -25 to 95°C, -20 to 80°C and -20 to 50°C. The -20 to 80°C temperature range is expected to be the most realistic for a deicing application. A specifically developed thermal cycling setup is used which enables fast thermal cycling. The achieved cycle times in the current research varied between 26.5 and 67.4 seconds and up to 144000 cycles were reached within two months. By using Peltier elements the sample is not exposed to cooling liquids and related effects on material composition or moisture content are thus avoided.

Of all thermal cycling tests, thermal cycling heated GLARE 5-2/1-0.3 with sample configuration II in the -20 to 50°C temperature range shows the largest decrease in interlaminar shear strength of -32.9%. The decrease in strength is already found after 8000 cycles. The larger width of the embedded copper heater element in configuration II, 5mm compared to 2.5mm in configuration I, and the lower maximum temperature of 50°C instead of 80°C or 95°C are important factors in this. The ILSS is mainly affected at the copper-epoxy interface and the positive effect of physical ageing due to elevated temperature exposure is minimal for 50°C. Right beside the heater element a maximum decrease in ILSS of only -10.2% is found after thermal cycling heated GLARE 5-2/1-0.3 between -20 and 50°C. The higher ILSS values after thermal cycling up to 80°C or 95°C can be explained by physical ageing of the epoxy at elevated temperature. The

365 effect of the heater element and the physical ageing are confirmed by results
found in previously reported research [1, 2].

The effect of moisture is especially present in the first stage of thermal cycling
(up to 12000 cycles). For heated FM906 glass-fibre epoxy an initial drop of -
5.3% in ILSS is found, however for heated GLARE 5-2/1-0.3 on the contrary an
370 increase up to +13.9% after 4000 cycles is found. Besides this initial increase in
ILSS strength for heated GLARE 5-2/1-0.3 due to moisture in the first stage up
to 12000 cycles, all tested samples with moisture show lower ILSS values after
thermal cycling than samples without moisture. Microscopic inspection and
comparison of the interfaces before and after thermal cycling did not reveal any
375 damage in the glass-fibre epoxy or the copper-epoxy interface due to moisture
conditioning and thermal cycling. The initial positive influence of moisture on
the ILSS is expected to be related to the sample submersion in 60°C water and
locally higher swelling and plasticizing of the glass-fibre epoxy at the edges which
postpones failure. Beyond 12000 cycles this initial effect is lost and decreased
380 ILSS values are found compared to the non-cycled and unconditioned reference.
The generally larger decrease in ILSS due to moisture and thermal cycling,
compared to thermal cycling only, is expected to be caused by a larger internal
stress relief due to overall plasticizing of the glass-fibre epoxy.

6. Acknowledgements

385 This study is funded by the Dutch Technology Foundation STW and Fokker
Aerostructures.

[1] Müller B, Hagenbeek M and Sinke J (2016) Thermal cycling of (heated)
Fibre Metal Laminates. *Composite Materials* 152, p.106-116.

[2] Hagenbeek M, Müller B, and Sinke J (2018) Effect of ther-
mal cycling and ageing on heated Fibre Metal Laminates and
390 glass-fibre epoxy composites. *Advanced Engineering Materials*.
<https://doi.org/10.1002/adem.201800084>.

- 395 [3] Beumler T (2004) Flying Glare, A contribution to aircraft certification issues on strength properties in non-damaged and fatigue damaged Glare structures. Ph.D. thesis, Delft University of Technology, Delft University Press, The Netherlands.
- [4] Botelho E C, Almeida R S, Pardini L C, Rezende M C (2007) Elastic properties of hygrothermally conditioned Glare laminate. *Int. J. Eng. Sci.* 45, p.163-172.
- 400 [5] Botelho E C, Rezende M C, Pardini L C (2008) Hygrothermal effects evaluation using the Iosipescu shear test for Glare laminates. *J. Braz. Soc. Mech. Sci. Eng.* 30, p.213-220.
- [6] Zhong Y and Joshi S C (2015) Response of hygrothermally aged GLARE 4A laminates under static and cyclic loadings, *Materials and Design* 87, 405 p.138-148.
- [7] Majerski K, Surowska B, and Bienias J (2018) The comparison of effects of hygrothermal conditioning on mechanical properties of fibre metal laminates and fibre reinforced polymers. *Composites Part B: Engineering*, 142, p.108-116.
- 410 [8] Borgonje B, Ypma M S (2003) Long Term Behaviour of Glare, *Applied Composite Materials* 10, p.243255.
- [9] Ypma M S (2001) Overview of tests concerning the influence of temperature and environmental exposure on Glare. Report B2V-00-41, Glare Research Program, Delft.
- 415 [10] Gkikas G, Douka D D, Barkoula N M, Paipetis A S (2014) Nano-enhanced composite materials under thermal shock and environmental degradation: A durability study, *Composites: Part B*, 70, p.206-214.
- [11] Sousa J M, Correia J R, Cabral-Fonseca S, and Diogo A C (2014) Effects of thermal cycles on the mechanical response of pultruded GFRP profiles used 420 in civil engineering applications. *Composite Structures*, 116, p.720-731.

- [12] Li H, Hu Y, Liu C, Zheng X, Liu H and Tao J (2016) The effect of thermal fatigue on the mechanical properties of the novel fiber metal laminates based on aluminium-lithium alloy. *composites: Part A* 84, p.36-42.
- [13] Park S Y, Choi W J, and Choi H S (2010) The effects of void contents on the long-term hygrothermal behaviors of glass/epoxy and GLARE laminates, *Composite Structures* 92 p.18-24.
- [14] Costa A A, da Silva D F N R, Travessa D N, and Botelho E C (2012) The effect of thermal cycles on the mechanical properties of fibre metal laminates, *Materials and Design*, 42 (1), p.434-440.
- [15] Müller B, Teixeira De Freitas S and Sinke J (2015) Thermal cycling fiber metal laminates: Considerations, test setup and results. In: *Proc. of the 20th Int. Conf. on Composite Materials (ICCM)*, Copenhagen, Denmark, 2015, paper no.4212-3, p.1-11.
- [16] Fibre Metal Laminates Centre of Competence, <http://www.fmlc.nl>, accessed 9.6.2018
- [17] Pacchione M and Telgkamp J (2006) Challenges of the metallic fuselage, *Proceedings of the 25th International congress of the aeronautical sciences (ICAS)*, p.1-12.
- [18] Vermeeren C A J R, Beumler Th, De Kanter J L C G, Van der Jagt O C and Out B C L (2003) Glare Design Aspects and Philosophies, *Applied Composite Materials* 10, p.257-276.
- [19] Hagenbeek M (2005) Characterisation of Fibre Metal Laminates under Thermo-mechanical Loadings, PhD thesis, TU Delft.
- [20] Federal Aviation Administration (FAA) (2010), Airplane and Engine Certification Requirements in Supercooled Large Drop, Mixed Phase and Ice Crystal Icing Conditions, *Federal Register* 75 (124), 37311-37339.

- [21] Mohseni M, and Amirfazli A (2013) A novel electro-thermal anti-icing system for fiber-reinforced polymer composite airfoils, *Cold Regions Science and Technology*, 87, p.47-58.
- 450 [22] Müller B, Anisimov A G, Sinke J and Groves R M (2015) Thermal strains in heated fibre metal laminates. *Proc. of the 6th Int. Con. on Emerging Technologies in Non-destructive Testing (ETNDT)*, p.1-6.
- [23] Alderliesten R C (2017) *Fatigue and Fracture of Fibre Metal Laminates. Solid Mechanics and Its Applications*. Springer International Publishing. Vol. 236, DOI 10.1007/978-3-319-56227-8_1
- 455 [24] Hagenbeek M, Van Hengel C, Bosker O J and Vermeeren C A J R (2003) Static Properties of Fibre Metal Laminates, *Applied Composite Materials* 10, p.207-222.
- [25] Odegard G M and Bandyopadhyay A (2011) Physical Aging of Epoxy Polymers and Their Composites, *J. of Polymer Science Part B: Polymer Physics*, 49 (24), p.1695-1716.
- 460 [26] Vlot A and Gunnink J W, eds. (2001) *Fibre metal laminates: An introduction*. Kluwer Academic Publishers. Dordrecht. The Netherlands.
- [27] Wijngaards D D L, Cretu E, Kong S H and Wolffenbuttel R F (2000) Modelling of integrated Peltier elements, *Proceedings of the 3rd International Technical Conference on Modelling and Simulation of Microsystems*, p.652-655.
- 465 [28] ASTM, Standard Test Method for Short-Beam Strength of Polymer Matrix Composite Materials and Their Laminates, ASTM standards, D2344/D2344M-13.
- 470