

## A fuzzy multi-attribute HAZOP technique (FMA-HAZOP): Application to gas wellhead facilities

Cheraghi, Morteza; Eslami Baladeh, Aliakbar; Khakzad, N.

**DOI**

[10.1016/j.ssci.2018.12.024](https://doi.org/10.1016/j.ssci.2018.12.024)

**Publication date**

2019

**Document Version**

Accepted author manuscript

**Published in**

Safety Science

**Citation (APA)**

Cheraghi, M., Eslami Baladeh, A., & Khakzad, N. (2019). A fuzzy multi-attribute HAZOP technique (FMA-HAZOP): Application to gas wellhead facilities. *Safety Science*, 114, 12-22.  
<https://doi.org/10.1016/j.ssci.2018.12.024>

**Important note**

To cite this publication, please use the final published version (if applicable).  
Please check the document version above.

**Copyright**

Other than for strictly personal use, it is not permitted to download, forward or distribute the text or part of it, without the consent of the author(s) and/or copyright holder(s), unless the work is under an open content license such as Creative Commons.

**Takedown policy**

Please contact us and provide details if you believe this document breaches copyrights.  
We will remove access to the work immediately and investigate your claim.

# **A fuzzy multi-attribute HAZOP technique (FMA-HAZOP): Application to gas wellhead facilities**

Morteza Cheraghi <sup>a</sup>, Aliakbar Eslami-Baladeh <sup>b</sup>, Nima Khakzad <sup>c,\*</sup>

a. University of Tehran, Iran, [cheraqi@ut.ac.ir](mailto:cheraqi@ut.ac.ir)

b. Amirkabir University of Technology, Iran, [a.eslami@aut.ac.ir](mailto:a.eslami@aut.ac.ir)

c. Delft University of Technology, The Netherlands. [n.khakzadrostami@tudelft.nl](mailto:n.khakzadrostami@tudelft.nl)

\* Corresponding author (N. Khakzad)

Address: Jaffalaan 5, Delft 2628BX, The Netherlands

Phone: +31 15 278 4709

## **Abstract:**

Hazard and Operability analysis (HAZOP) is a popular technique for hazard identification and risk ranking in hazardous facilities. Conventional HAZOP, however, has some drawbacks: (i) it considers a limited number of risk factors, i.e., only the frequency and the severity of hazards; (ii) it assumes equal weights for the risk factors, thus ranking low-probability high-consequence hazards equally important as high-probability low-consequence hazards; and (iii) it uses crisp and precise data which is rarely available or highly uncertain, especially in the case of complex oil and gas facilities.

The present study is an attempt to alleviate the foregoing drawbacks of conventional HAZOP via a Fuzzy Multi-Attribute HAZOP technique (FMA-HAZOP). To do this, Analytic Hierarchy Process (AHP) and the Technique for Order of Preference by Similarity to Ideal Solution (TOPSIS) are used, both in a fuzzy environment, to determine the weight of risk factors and to prioritize the hazards. The application of the FMA-HAZOP on a gas wellhead facility shows that FMA-HAZOP presents a more transparent and more detailed information about the rank of hazards compared to conventional HAZOP.

**Keywords:** Risk assessment; HAZOP; Gas wellhead facility; Fuzzy logic; TOPSIS; AHP

## 1. Introduction

Failures in the oil and gas industry can lead to catastrophic accidents. In addition to casualties of such accidents, their financial, societal, and environmental impacts are very important (Guo et al. 2016). Accidents at oil and gas facilities usually occur in the form of major hydrocarbon release, explosion, and fire (Khakzad et al., 2013; Cheraghi et al. 2018), threatening the integrity of the facilities and the assets of the stakeholders. The importance of safety in oil wells and relevant process facilities and the challenges faced in their hazard identification have been reported in the previous studies (Brandsæter 2002, Khakzad et al. 2013, Ataallahi and Shadizadeh 2015, Lavasani et al. 2015). Despite the development in design techniques and safety systems, faults still occur in gas wellhead facilities. For instance, failure of gas wellhead – a safety critical system in oil wells – resulted in blowouts and subsequent fires in southern Iran in 2007 (ADAMS and MAKVANDI 2007) and BP's Macondo well in the Gulf of Mexico in 2010 (Vinnem 2018).

Hazard and Operability (HAZOP) study is a well-known and effective risk assessment technique for identifying potential hazards and operability problems in hazardous industries (Dunjó et al. 2010; Ahn and Chang 2016, O Herrera et al. 2018). In HAZOP, after the identification of the hazards, the risk index of the hazards is calculated by a risk matrix or simply by multiplying the Frequency (F) and the Severity (S) of the consequence of each hazard. HAZAOP, like other traditional risk evaluation techniques, suffers from major drawbacks (Grassi et al. 2009), and a large amount of research has been conducted to improve and respond to these limitation (Marhavidas et al. 2011; Khakzad et al., 2011). In this regard, the drawbacks of HAZOP can be explained in three categories:

(I) Conventional HAZOP only considers F and S as the risk factors, ignoring other fundamental aspects of risk such as workplace characteristics and human factors although the inclusion of such factors can significantly improve the quality of risk evaluation. In this regard, factors such as the capability of organization in reaction to risk (Mikulak et al. 2008), sensitivity to personal protective equipment (Grassi et al. 2009), sensitivity to maintenance (Grassi et al. 2009), safety culture (Pinto 2014), the number of risk sources (Biyikli and Aydogan 2016), the number of persons exposed (Djapan et al. 2018), and stress (Aras et al. 2014) have been introduced as risk factors.

(II) HAZOP uses absolute and precise numbers to identify risk factors, which in the case of complex systems and rare failures turns out to be very challenging. For instance, numerical quantification of the

severity of the consequences by experts is very subjective if not practically impossible; furthermore, due to data scarcity and incomplete knowledge of the experts, the accurate estimation of the frequencies in the form of crisp and precise probabilities is usually prone to a high level of uncertainty (epistemic uncertainty).

Regarding the disadvantage of using crisp and precise expert judgments, several researchers have used uncertainty analysis to show the inconsistencies in the experts' opinion (Nilsen and Aven 2003). One effective way to deal with this type of uncertainty, which arises due to data scarcity and incomplete knowledge of experts, is fuzzy logic (Zadeh 1965). Fuzzy logic has been effectively used to improve the performance and credibility of risk assessment techniques (Sii et al. 2001; Jamshidi et al. 2013).

(III) HAZOP gives equal weights to the risk factors, resulting in the same ranks for both a low-probability high-consequence hazard and a high-probability low-consequence hazard. Multi-attribute decision making (MADM) techniques such as Analytic Hierarchy Process (AHP) (Saaty 1977) and Technique for Order of Preference by Similarity to Ideal Solution (TOPSIS) (Hwang and Yoon 1981) can be used to identify the weights and ranks of risk factors (Othman et al. 2016, Kokangül et al. 2017, Raviv et al. 2017). Integration of fuzzy logic and MADM techniques can further improve the performance of decision making under uncertainty. For instance, Fuzzy AHP (Chang, 1996) has been employed to determine the relative weight of risk factors (Patil and Kant 2014; Gul and Guneri 2016; Wang et al. 2016, Zhou et al. 2017). Fuzzy TOPSIS (Chen 2000) has also been widely used for ranking the hazards (Akyildiz and Mentis 2017; Carpitella et al. 2018).

There have been several attempts to integrate fuzzy theory and MADM techniques in HAZOP study. For instance, Fuzzy theory has been used to evaluate the importance of parameters (Pan et al. 2012, Gao and Wang 2018), to improve the risk matrix (Ahn and Chang 2016; Fuentes-Bargues et al. 2016; Markowski and Siuta 2018), and to assess the frequency factor (F) (HU et al. 2009; Wei et al. 2009). In addition, AHP has been used for defining weight of parameters and deviations (Kang et al. 2015, Othman et al. 2016, Aziz et al. 2017) and optimal allocation of HAZOP resources (Kang et al. 2015).

As discussed above, the fuzzy theory and MCDM techniques have been applied, mostly separately, to improve the performance of HAZOP in the previous studies. Thus, the present study aims to integrate the previous methodologies to develop a Fuzzy Multi-Attribute HAZOP (FMA-HAZOP) technique, where AHP and TOPSIS are used in a fuzzy environment to weigh the risk factors and to rank the hazards,

respectively. Besides, a new risk factor, sensitivity to failure of safety measures, is defined to account for the influence of the failure of safety measures on risk. The technique is applied to a gas wellhead facility. The rest of the work is organized as follows: gas wellhead facilities are described in Section 2. The FMA-HAZOP is developed in Section 3. Results of the conventional HAZOP and the FMA-HAZOP are compared in Section 4. Section 5 presents the conclusions of the study.

## **2. System Description**

Gas wellhead facilities are used in the production of natural gas and condensate. These facilities convey the fluids to manifolds in a cost-effective and safe (Lavasani et al. 2011). A gas wellhead facility includes a wellhead, flow lines, corrosion inhibitor injection facilities, a heater facility, a flare, a burn pit, a hydraulic shut down system, pig receiver facilities, a methanol system, a header, and a trunk line.

In our case study, the heater facility and the methanol system have been eliminated from the wellhead facility since the site is located in tropical areas (the site location is in Kangan, Bushehr Province, southern Iran; the average temperature in February: 23 °C). The surface pressure is controlled by a Christmas Tree installed on top of the wellhead. The Christmas Tree consists of spools, fittings, and valves. Wellhead facilities have two main safety valves, a Sub-Surface Safety Valve (SSSV) and a Surface Safety Valve (SSV), to control and safely convey the fluids to the surface. In addition, two types of choke valves, fixed and adjustable, are used to control the flow of fluids during production. There are also valves on wellhead facilities such as the Lower Master Valve (LMV), the Upper Master Valve (UMV), the production valve, and the Pressure Safety Valve (PSV) (Standard 2004, Lavasani et al. 2011). A separator is located in the flow line to separate the production fluids into liquid and gaseous components. Wellhead facilities have many instrumentation systems such as transmitters, controllers, alarms and switches. The flare and the burn pit are used for unplanned (over pressure) or planned (start up, shutdown, or testing) combustion of fluids. The flare line has a knockout drum (K.O. drum) upstream of the flare to remove any liquid from gases (Devold 2013).

The corrosion inhibitor injection facilities are used to mitigate corrosion by injecting chemical corrosion inhibitors into the flow lines. The corrosion inhibitor tank works in atmospheric condition. A Pig is a device which traverses inside the pipe for performing various maintenance operations (e.g., internal cleaning, pipeline drying, internal coating and inspection). A pig launcher is a device to launch the pig into the pipeline, and a pig receiver is a device to retrieve the pig (Devold 2013). The Piping and Instrumentation Diagram (P&ID) of wellhead facilities is represented in Fig. 1.

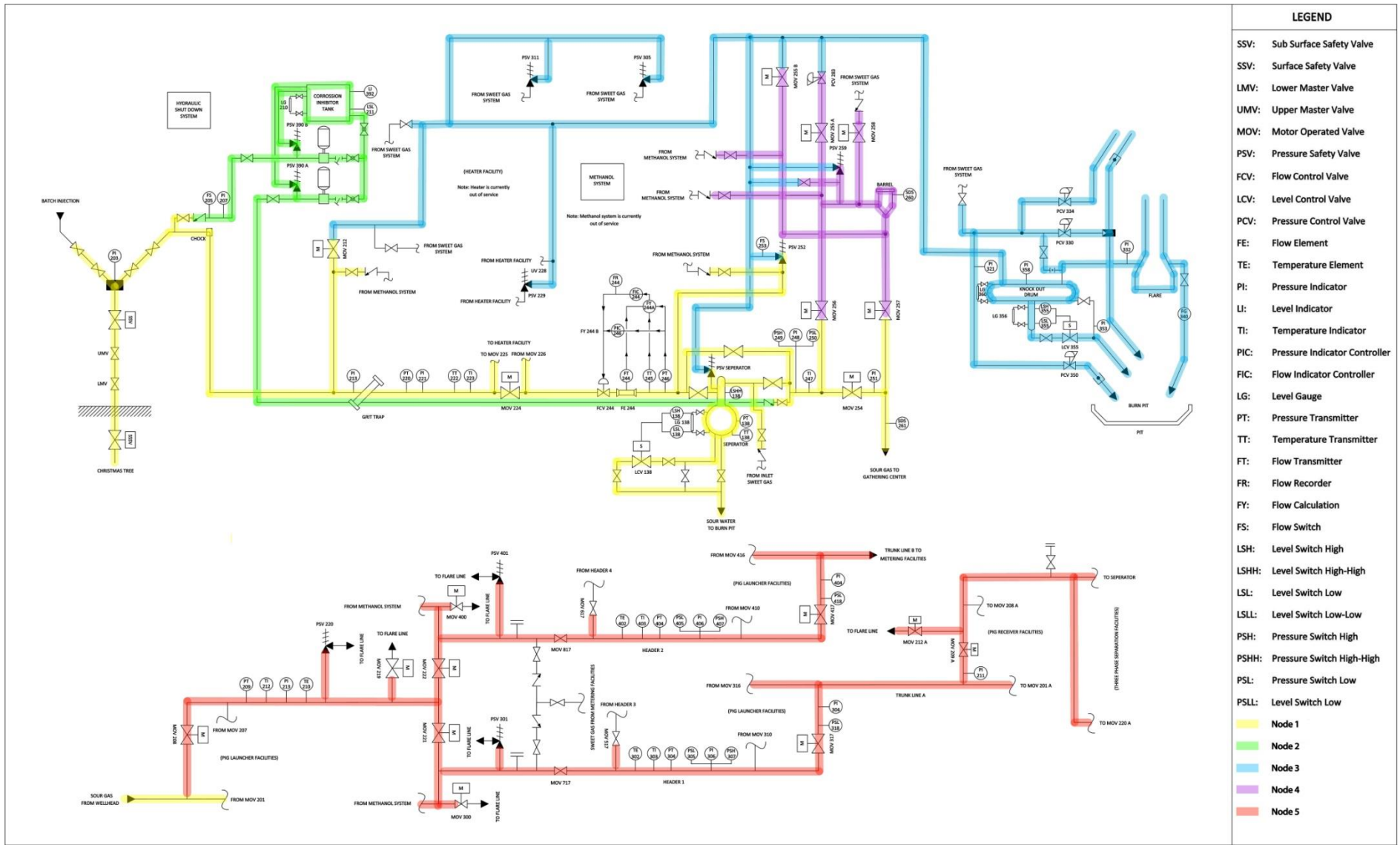

LEGEND	
SSV:	Sub Surface Safety Valve
SSV:	Surface Safety Valve
LMV:	Lower Master Valve
UMV:	Upper Master Valve
MOV:	Motor Operated Valve
PSV:	Pressure Safety Valve
FCV:	Flow Control Valve
LCV:	Level Control Valve
PCV:	Pressure Control Valve
FE:	Flow Element
TE:	Temperature Element
PI:	Pressure Indicator
LI:	Level Indicator
TI:	Temperature Indicator
PIC:	Pressure Indicator Controller
FIC:	Flow Indicator Controller
LG:	Level Gauge
PT:	Pressure Transmitter
TT:	Temperature Transmitter
FT:	Flow Transmitter
FR:	Flow Recorder
FY:	Flow Calculation
FS:	Flow Switch
LSH:	Level Switch High
LSHH:	Level Switch High-High
LSL:	Level Switch Low
LSLL:	Level Switch Low-Low
PSH:	Pressure Switch High
PSHH:	Pressure Switch High-High
PSL:	Pressure Switch Low
PSLL:	Level Switch Low
	Node 1
	Node 2
	Node 3
	Node 4
	Node 5

Fig. 1. P&ID of a wellhead facility. Nodes of HAZOP analysis have been denoted with different colors.

1 **3. Materials and Method**

2 Compared to the conventional HAZOP, which considers two risk factors of equal importance, in the FMA-  
 3 HAZOP, we consider five risk factors the weight of which to be determined using AHP. Having the hazards  
 4 and their corresponding risk indices determined, TOPSIS is used to prioritize and rank order the hazards.  
 5 To tackle the uncertainty in experts' opinion, we combine both AHP and TOPSIS with fuzzy logic. The  
 6 steps for developing the FMA-HAZOP are presented in Fig. 2, and will be described in more detail in the  
 7 following subsections.

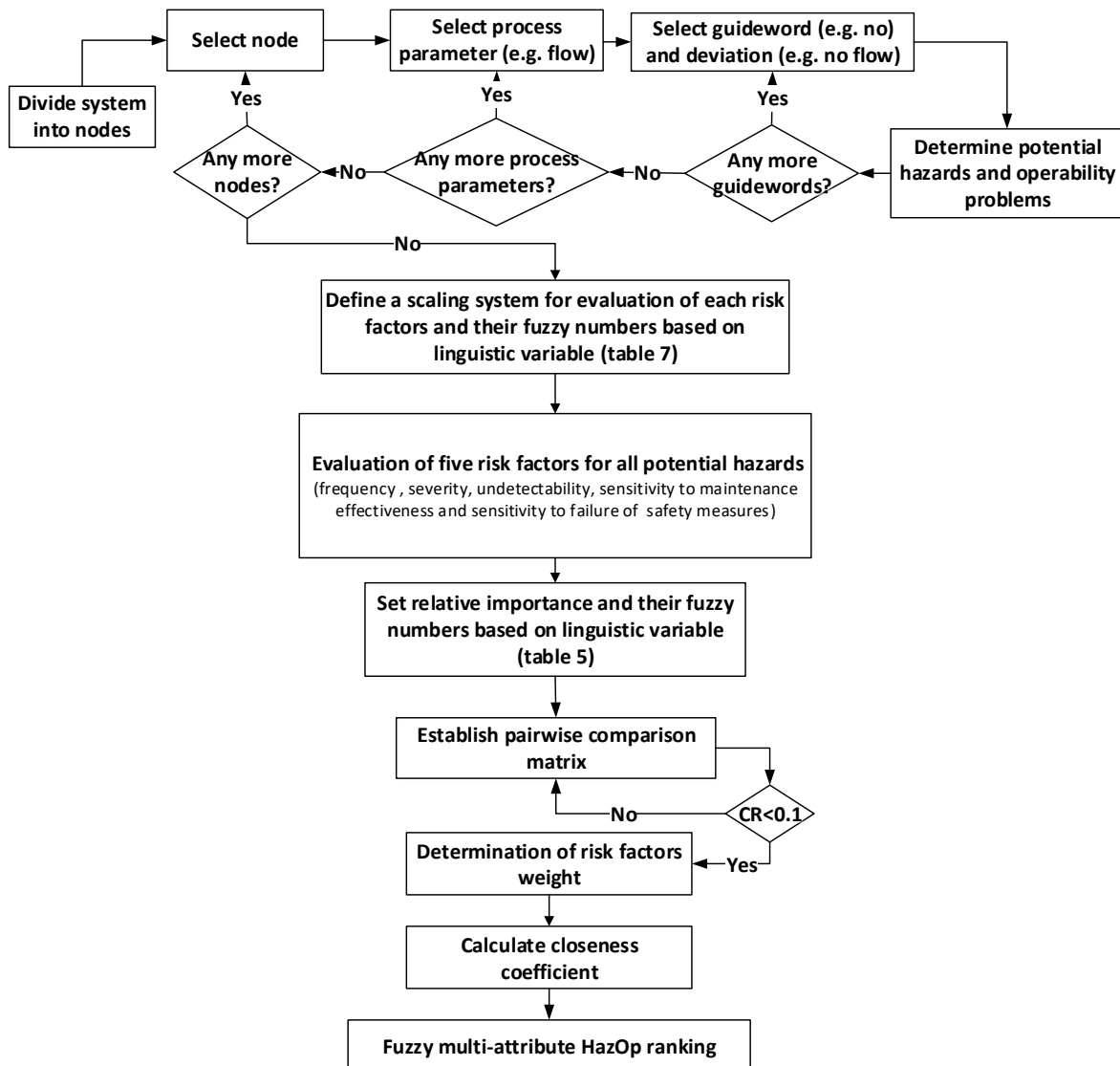

8  
 9 **Fig. 2.** Flowchart of FMA-HAZOP.

10 **3.1. HAZOP Analysis**

11 In HAZOP analysis, if the system or process under study deviates from its design limits, accidents may  
 12 occur. Relevant documents such as process description, process flow diagram, and P&ID along with

1 subject matter experts' opinion are used to identify design limits of the system, possible deviations, and  
 2 potential consequences. The system is then broken down into simpler sections each of which being  
 3 treated as a node in the HAZOP analysis. Based on the process intent, the relevant process parameters  
 4 (flow, temperature, pressure, etc.) are defined. By combining the HAZOP guide words (no, more, less, etc.)  
 5 with the identified process parameters, possible deviations from the design intent can be identified. As an  
 6 example, the deviation "high pressure" can be identified by applying the guide word "high" to the process  
 7 parameter "pressure". Potential causes of the defined deviations and their potential consequences should  
 8 also be considered. Potential causes may be equipment or operational failures. All meaningful deviations  
 9 related to each node should be considered. Table 1 exemplifies the guide words used in the HAZOP  
 10 analysis (IEC:61882 2001).

**Table 1:** Guide words used in HAZOP and their meaning (IEC:61882 2001).

Guide word	Definitions
No/not	Complete negation of the design intent
More	Quantitative increase
Less	Quantitative decrease
As well as	Qualitative modification/increase
Part of	Qualitative modification/decrease
Other than	Complete substitution

11 In the conventional HAZOP, based on qualitative evaluation of the frequency (Table 2) and the severity of  
 12 consequences (Table 3), a risk matrix (Fig. 3) is used to rank the risks (Table 4).

**Table 2:** Frequency evaluation of consequences in HAZOP (IEC:61882 2001)

Category	Description
1	Not expected to occur during the facility lifetime
2	Expected to occur no more than once during the facility lifetime
3	Expected to occur several times during the facility lifetime
4	Expected to occur more than once in a year

13

**Table 3:** Severity evaluation of consequence in HAZOP (IEC:61882 2001)

Category	Description
1	No injury/ less than one week of production loss/ less than 0.1 millions of dollars equipment damage
2	Minor injury/ between one week and one month of production loss/ between 0.1 and 1 millions of dollars equipment damage
3	Injury/ between one and six months of production loss/ between 1 and 10 millions of dollars equipment damage
4	Death or severe health effects/ more than six months of production loss/ above 10 millions of dollars equipment damage



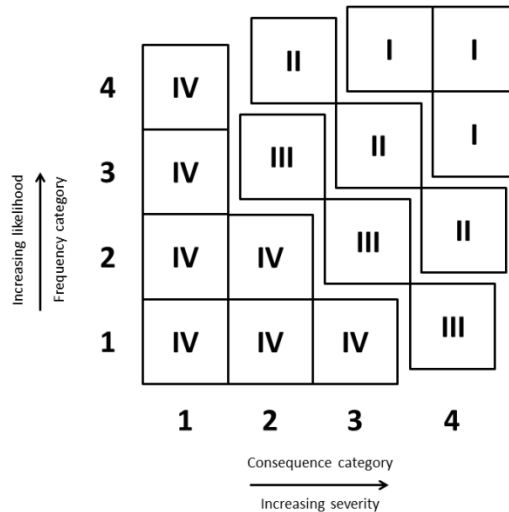

Fig. 3. Risk matrix (CCPS, 2010)

Table 4: Risk ranking of consequences in HAZOP (IEC:61882 2001)

Number	Category	Description
I	Unacceptable	Should be mitigated with engineering and/or administrative controls to a risk ranking of III or less within a specified time period (e.g., 6 months).
II	Undesirable	Should be mitigated with engineering and/or administrative controls to a risk ranking of III or less within a specified time period (e.g., 12 months).
III	Acceptable with controls	Should be verified that procedures or controls are in place
IV	Acceptable as is	No mitigation required

### 3.2. Definition of Risk Factors

In the present study, five risk factors are taken into account: frequency (F), severity of consequences (S), un-detectability (U), the sensitivity to maintenance effectiveness (SM), and the sensitivity to failure of safety measures (SSM). The definitions of risk factors in this study are:

- Frequency (F)

This factor considers the frequency by which a specific consequence of the hazard would appear. Failure of safety measures and imperfect maintenance can affect the frequency of certain consequences; in this step, for evaluation of this factor, we assume that all the safety measures are operational, and scheduled maintenance activities have been conducted.

- Severity (S)

The severity of the resulting consequences such as injuries and fatalities, damage to the equipment, the environmental impact and business interruption are considered in the evaluation of this factor. In this

1 step, the possibility and the effect of safety measures failure and imperfect maintenance are taken into  
2 account in order to consider the highest level of severity.

3 • Un-detectability (U)

4 Detectability measures the possibility of failures being foreseen/detected before the accident occurs so  
5 that the accident can be prevented or mitigated; un-detectability implies the opposite.

6 • Sensitivity to maintenance effectiveness (SM)

7 Maintenance has previously been considered in some studies as a risk factor (Grassi et al. 2009, Biyikli  
8 and Aydogan 2016). Besides, inefficient maintenance has resulted in some major accidents (Okoh and  
9 Haugen 2013). Imperfect maintenance of equipment can increase both the frequency and the severity of  
10 hazards. Sensitivity to maintenance (SM) is an indication of such increase (Grassi et al. 2009). Thus,  
11 hazards with a higher sensitivity to quality of maintenance activity have a higher risk.

12 • Sensitivity to failure of safety measures (SSM)

13 The failure of safety measures – both physical and non-physical – in process facilities has contributed to  
14 many catastrophic accidents (Lees, 2012). Some researchers have considered the physical presence of  
15 safety measures (Hatami-Marbini et al. 2013; Pinto 2014) and safety-measure-related factors such as the  
16 “current safety level” (Gürcanli and Müngen 2009), and the “adequacy of the existing protection  
17 measures” (Murè and Demichela 2009) as risk factors. To measure this factor, the analyst should estimate  
18 the impact of failure of all related safety measures on the risk of the hazards.

19 **3.3. Fuzzy logic**

20 A fuzzy set (or number)  $\tilde{M}$  in a universe of discourse  $x$  is characterized by a membership function  $\mu_{\tilde{M}}(x)$   
21 which assigns a real number in the interval  $[0, 1]$  to each element  $x$  of  $X$  to indicate the grade of  
22 membership of  $x$  in  $\tilde{M}$ . A triangular fuzzy number  $\tilde{M}$  can be identified as a triplet  $(l, m, u)$  as presented in  
23 Fig. 4 and Eq. (1) (Zimmermann 2011), where  $l$ ,  $m$  and  $u$  are the lower, the middle and the upper bounds  
24 of  $\tilde{M}$ , respectively. A comparison between a crisp set and a fuzzy set is also depicted in Fig. 5.

25

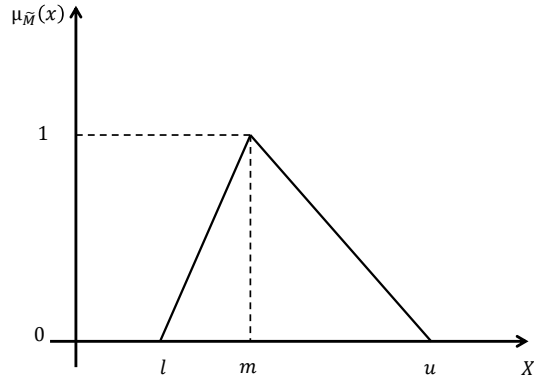

**Fig. 4.** Schematic of a triangular fuzzy number (Zimmermann 2011).

1

2

3

$$\mu_{\tilde{M}}(x) = \begin{cases} 0 & x \leq l \\ \frac{x-l}{m-l} & l \leq x \leq m \\ \frac{u-x}{u-m} & m \leq x \leq u \\ 0 & x \geq u \end{cases} \quad (1)$$

5 Considering the two triangular fuzzy numbers  $\tilde{M}_1 = (l_1, m_1, u_1)$  and  $\tilde{M}_2 = (l_2, m_2, u_2)$ , the operational  
6 laws are defined as (Chen 2000, Zimmermann 2011):

$$(l_1, m_1, u_1) \oplus (l_2, m_2, u_2) = (l_1 + l_2, m_1 + m_2, u_1 + u_2) \quad (2)$$

$$(l_1, m_1, u_1) \odot (l_2, m_2, u_2) \approx (l_1 l_2, m_1 m_2, u_1 u_2) \quad (3)$$

$$(\lambda, \lambda, \lambda) \odot (l_1, m_1, u_1) = (\lambda l_1, \lambda m_1, \lambda u_1); \lambda > 0, \lambda \in R, \lambda \text{ is a crisp number} \quad (4)$$

$$(l_1, m_1, u_1)^{-1} = (1/u_1, 1/m_1, 1/l_1) \quad (5)$$

11 The distance between  $\tilde{M}_1$  and  $\tilde{M}_2$  is calculated as:

$$d(\tilde{M}_1, \tilde{M}_2) = \sqrt{\frac{1}{3}[(l_1 - l_2)^2 + (m_1 - m_2)^2 + (u_1 - u_2)^2]} \quad (6)$$

13

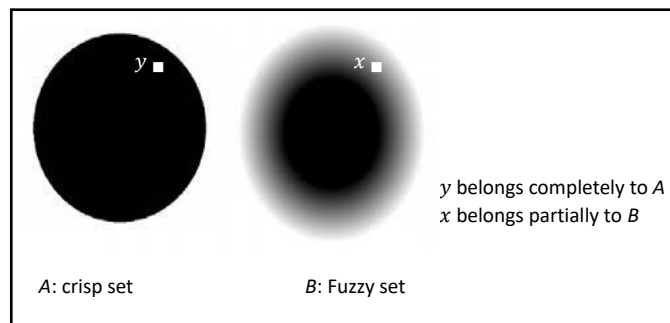

14

**Fig. 5.** Presentation of crisp and fuzzy sets (Zimmermann 2011).

15

16

17

1 **3.4. Weighing risk factors via fuzzy AHP**

2 In this step, weight of the risk factors is determined using the fuzzy AHP (Chang 1996). The triangular  
3 fuzzy scales of relative importance used in pairwise comparison are presented in Table 5.

4

**Table 5:** Fuzzy numbers of relative importance in pairwise comparison.

Description	Triangular fuzzy number
Complete and utter importance	$(\frac{5}{2}, 3, \frac{7}{2})$
Much stronger importance	$(2, \frac{5}{2}, 3)$
Stronger importance	$(\frac{3}{2}, 2, \frac{5}{2})$
Low importance	$(1, \frac{3}{2}, 2)$
Approximately equal importance	$(\frac{1}{2}, 1, \frac{3}{2})$
Exactly equal importance	$(1, 1, 1)$

5

6 All the elements on the main diagonal of the pairwise comparison matrix are (1, 1, 1) while the element  
7 on the  $i^{\text{th}}$  row and the  $j^{\text{th}}$  column is:

8 
$$\tilde{M}_{gi}^j = (l_{ij}, m_{ij}, u_{ij}) \tag{7}$$

9 Accordingly, the element on the  $j^{\text{th}}$  row and the  $i^{\text{th}}$  column can be determined as:

10 
$$\tilde{M}_{gj}^i = (\tilde{M}_{gi}^j)^{-1} = (l_{ij}, m_{ij}, u_{ij})^{-1} = (\frac{1}{u_{ij}}, \frac{1}{m_{ij}}, \frac{1}{l_{ij}}) \tag{8}$$

11 The consistency of the comparison matrix established this way can be checked using the consistency ratio  
12 (CR). To do so, pairwise fuzzy numbers should be converted to crisp numbers via a defuzzification  
13 process. In this study, the graded mean integration approach (Zimmermann 2011) is used for  
14 defuzzification of the fuzzy numbers of the comparison matrix. The fuzzy number  $\tilde{M} = (l, m, u)$  is  
15 transformed into a crisp number M as:

16 
$$P(\tilde{M}) = M = \frac{l+4m+u}{6} \tag{9}$$

17 After defuzzification of each fuzzy number of the comparison matrix, the consistency ratio (CR) of the  
18 matrix can be calculated as the ratio of the consistency index (CI) and the random consistency index (RI)  
19 (Saaty 1980):

20 
$$CR = \frac{CI}{RI} \tag{10}$$

21 CI and RI can be identified using Eq. (11) and Table 6, respectively.

22 
$$CI = \frac{\lambda_{max} - n}{n - 1} \tag{11}$$

1 where  $\lambda_{max}$  is the largest eigenvalue, and  $n$  is the number of factors being compared in the matrix. If CR is  
 2 lower than 0.1, the assigned weight amounts are consistent, which otherwise should be reassigned.  
 3

**Table 6:** Random consistency index (Saaty 1980).

<b>n</b>	1	2	3	4	5	6	7	8	9	10
Random consistency index (RI)	0	0	0.52	0.89	1.11	1.25	1.35	1.40	1.45	1.49

4  
 5 Assume that  $X = \{x_1, x_2, x_3, \dots, x_n\}$  is an object set, and that  $U = \{u_1, u_2, u_3, \dots, u_m\}$  is a goal set. For each  
 6 object-goal pair, the extent analysis should be performed (Chang 1996), resulting in  $m$  extent analysis  
 7 values for each object:

$$8 \quad \tilde{M}_{g_1}^1, \tilde{M}_{g_2}^2, \dots, \tilde{M}_{g_n}^m \quad (12)$$

9 where  $\tilde{M}_{g_i}^j \{i = 1, 2, \dots, n \text{ and } j = 1, 2, \dots, m\}$  are triangular fuzzy numbers. The value of fuzzy synthetic  
 10 extent with respect to the  $i^{\text{th}}$  object is itself a triangular fuzzy number which can be defined as:

$$11 \quad \tilde{S}_i = \sum_{j=1}^m \tilde{M}_{g_i}^j \odot [\sum_{i=1}^n \sum_{j=1}^m \tilde{M}_{g_i}^j]^{-1} \quad (13)$$

12 For  $\tilde{M}_1 = (l_1, m_1, u_1)$  and  $\tilde{M}_2 = (l_2, m_2, u_2)$ , the possibility degree of  $\tilde{M}_1 \geq \tilde{M}_2$ , denoted as  $V(\tilde{M}_1 \geq \tilde{M}_2)$ , is  
 13 given as:

$$14 \quad V(\tilde{M}_2 \geq \tilde{M}_1) = \begin{cases} 1 & \text{if } m_2 \geq m_1 \\ 0 & \text{if } l_1 \geq u_2 \\ \mu_{\tilde{M}_1}(d) = \frac{l_1 - u_2}{(m_2 - u_2) - (m_1 - l_1)} & \text{otherwise} \end{cases} \quad (14)$$

15 where  $d$  is the horizontal coordinate of the highest intersection point  $D$  of  $\mu_{\tilde{M}_1}$  and  $\mu_{\tilde{M}_2}$  (Fig. 6). Similarly,  
 16 the possibility degree of  $\tilde{M} \geq \tilde{M}_1, \tilde{M}_2, \tilde{M}_3, \dots, \tilde{M}_k$  is given by:

$$17 \quad V(\tilde{M} \geq \tilde{M}_1, \tilde{M}_2, \tilde{M}_3, \dots, \tilde{M}_k) = \min V(\tilde{M} \geq \tilde{M}_i), \quad i = 1, 2, \dots, k, \quad (15)$$

18 The weight of factors in the comparison matrix can be calculated as:

$$19 \quad d'(A_i) = \min V(\tilde{S}_i \geq \tilde{S}_k) \quad k = 1, 2, \dots, n; k \neq i \quad (16)$$

20 Having the weight vector  $W' = (d'(A_1), d'(A_2), \dots, d'(A_n))^T$ , the normalized weight vector  $W$  can be  
 21 calculated as:

$$22 \quad W = (d(A_1), d(A_2), \dots, d(A_n))^T \quad (17)$$

23

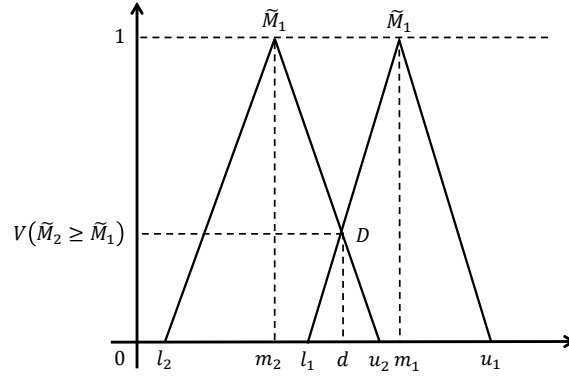

**Fig. 6.** The intersection between two triangular fuzzy numbers  $\tilde{M}_2$  and  $\tilde{M}_1$  (Chang 1996).

1

### 2 **3.5. Ranking hazards using fuzzy TOPSIS**

3 The fuzzy TOPSIS is a technique for multi-attribute decision making under uncertainty particularly when  
 4 the number of alternatives to consider (hazards in the present study) is large (Grassi et al. 2009). In this  
 5 technique, an optimal alternative should have the shortest and the farthest distances, respectively, from  
 6 the positive and negative ideal solutions. The linguistic variables and the corresponding triangular fuzzy  
 7 numbers used in the fuzzy TOPSIS for evaluation of risk factors are shown in Table 7.

8

**Table 7:** Linguistic variables and the corresponding fuzzy numbers in fuzzy TOPSIS.

linguistic variable	Symbol	Triangular fuzzy number
Negligible	NE	(0,0,1)
Very low	VL	(0,1,2)
Low	LO	(1,2,3)
Medium low	ML	(2,3,4)
Fair	FA	(3,4,5)
Medium high	MH	(4,5,6)
High	HI	(5,6,7)
Very high	VH	(6,7,8)
Absolutely high	AH	(7,8,9)
Maximum	MA	(8,9,9)

9

10 Assume that the fuzzy rating of the decision maker about the  $i^{\text{th}}$  alternative  $A_i$  based on the  $j^{\text{th}}$  criterion  $C_j$   
 11 can be presented as  $\tilde{x}_{ij} = (a_{ij}, b_{ij}, c_{ij})$ , where the weight of the criterion  $C_j$  is calculated from Eq. (17) as  
 12  $\tilde{w}_j = (w_{j1}, w_{j2}, w_{j3})$ . The problem can be expressed in a matrix form as:

$$1 \quad \tilde{D} = \begin{matrix} & C_1 & C_2 & \dots & C_j & \dots & C_n \\ A_1 & \tilde{x}_{11} & \tilde{x}_{12} & \dots & \tilde{x}_{1j} & \dots & \tilde{x}_{1n} \\ A_2 & \tilde{x}_{21} & \tilde{x}_{22} & \dots & \tilde{x}_{2j} & \dots & \tilde{x}_{2n} \\ \vdots & \vdots & \vdots & \vdots & \vdots & \vdots & \vdots \\ A_i & \tilde{x}_{i1} & \tilde{x}_{i2} & \dots & \tilde{x}_{ij} & \dots & \tilde{x}_{in} \\ \vdots & \vdots & \vdots & \vdots & \vdots & \vdots & \vdots \\ A_m & \tilde{x}_{m1} & \tilde{x}_{m2} & \dots & \tilde{x}_{mj} & \dots & \tilde{x}_{mn} \end{matrix} \quad (18)$$

$$2 \quad \tilde{W} = [\tilde{w}_1, \tilde{w}_2, \dots, \tilde{w}_j, \dots, \tilde{w}_n] \quad (19)$$

3 where  $A_i$  are possible alternatives (hazards in this study), and  $C_j$  are the criteria (risk factors in this  
4 study). The decision matrix  $D$  needs to be normalized. The normalized matrix  $\tilde{R}$  is defined as:

$$5 \quad \tilde{R} = [\tilde{r}_{ij}]_{m \times n} \quad (20)$$

6 where:

$$7 \quad \tilde{r}_{ij} = \begin{cases} \left( \frac{a_{ij}}{c_j^+}, \frac{b_{ij}}{c_j^+}, \frac{c_{ij}}{c_j^+} \right) & j \in B; \\ \left( \frac{a_j^-}{c_{ij}}, \frac{a_j^-}{b_{ij}}, \frac{a_j^-}{a_{ij}} \right) & j \in C; \end{cases} \quad (21)$$

8  $B$  and  $C$  are the set of benefit and cost criteria, respectively.  $c_j^+ = \max_i c_{ij}$  if  $j \in B$ , and  $a_j^- = \min_i a_{ij}$  if  
9  $j \in C$ .

10 Considering the different importance of each criterion, the weighted normalized fuzzy decision matrix  
11 can be constructed as:

$$12 \quad \tilde{V} = [\tilde{v}_{ij}]_{m \times n}, \quad i = 1, 2, \dots, m, j = 1, 2, \dots, n; \quad (22)$$

13 where  $\tilde{v}_{ij} = \tilde{r}_{ij} \cdot \tilde{w}_j$ .

14 We can define the fuzzy positive-ideal solution  $A^+ = (\tilde{v}_1^+, \tilde{v}_2^+, \dots, \tilde{v}_j^+, \dots, \tilde{v}_n^+)$  and fuzzy negative-ideal  
15 solution  $A^- = (\tilde{v}_1^-, \tilde{v}_2^-, \dots, \tilde{v}_j^-, \dots, \tilde{v}_n^-)$  where  $\tilde{v}_j^+ = (1, 1, 1)$  and  $\tilde{v}_j^- = (0, 0, 0)$  for  $j = 1, 2, \dots, n$ .

16 Distance of each alternative from  $A^+$  and  $A^-$  can be calculated as:

$$17 \quad d_i^+ = \sum_{j=1}^n d(\tilde{v}_{ij}, \tilde{v}_j^+), \quad i = 1, 2, \dots, m, \quad (23)$$

$$18 \quad d_i^- = \sum_{j=1}^n d(\tilde{v}_{ij}, \tilde{v}_j^-), \quad i = 1, 2, \dots, m, \quad (24)$$

19 The closeness coefficient (CC) can be used to determine the rank order of the alternatives:

$$20 \quad CC_i = \frac{d_i^-}{d_i^+ + d_i^-}, \quad i = 1, 2, \dots, m, \quad (25)$$

21

22

23

24

1 **4. Results and discussions**

2 **4.1. HAZOP analysis**

3 To perform the HAZOP study, the P&ID of the gas wellhead facility (Fig. 1) is divided into five sections or  
4 nodes as listed in Table 8. For each node, several meaningful deviations, i.e., the ones with credible causes  
5 and consequences, can be considered. Disregarding unlikely deviations such as the "low temperature"  
6 which does not occur according to the site's geographical location, the meaningful deviations along with  
7 their causes and potential consequences have been listed in Table 9.

8

**Table 8:** List of nodes for HAZOP analysis of gas wellhead facility.

9

Node	Title
1	Wellhead and flow line
2	Corrosion inhibitor injection facilities
3	Flare and burn pit facilities
4	Pig receiver facilities
5	Header and trunk Line

10



**Table 9: Results of HAZOP analysis.**

Hazard No.	Node	guideword	Parameter	Deviation	Causes	Consequences
1	1	No/less	Flow	No/less flow of gas	Closure of SSSV, failure of hydraulic panel system (e.g., leakage in tubing, power failure, pump failure, and transmitter failure)	Loss of production
2	1	No/less	Flow	No/less flow of gas	Closure of SSV, failure of hydraulic panel system (e.g., leakage in tubing, power failure, pump failure, and transmitter failure)	Loss of production
3	1	No/less	Flow	No/less flow of gas	Closure of manual valve (e.g., production valve, LMV, and UMV) on Christmas Tree	Loss of production
4	1	No/less	Flow	No/less flow of gas	Closure of adjustable choke valve and or plugging of fixed/adjustable choke valve by debris/grit	Loss of production
5	1	No/less	Flow	No/less flow of gas	Failure of FCV 244 or failure of any elements of the control system to close more	Loss of production
6	1	No/less	Flow	No/less flow of gas	Closure of MOV 224	Loss of production
7	1	No/less	Flow	No/less flow of gas	Closure of MOV 254	Increase pressure upstream of the valve and possibility of damage to line due to over pressure
8	1	No/less	Flow	No/less flow of gas	Plugging of Grit Trap	Loss of production
9	1	High	Level	High level in the separator	Failure of LCV 138 under the separator or any elements of the control system to close more	Sour liquid carry over to downstream and thus increasing the rate of corrosion, increasing liquid hold-up in flow lines, gradual increasing of the back pressure
10	1	High	Level	High level in the separator	Closure of any manual drain valve downstream of LCV 138	Sour liquid carry over to downstream and thus increasing rate of corrosion, increasing liquid hold-up in flow lines, gradual increasing of the back pressure
11	1	Low	Level	Low level in separator	Failure of LCV 138 under the separator or any elements of the control system to open more	Toxic gas blow-by to burn pit leading to loss of gas
12	1	High	Pressure	High Pressure	Fire case	Possibility of damage to the separator due to over pressure
13	1	More	Flow	More flow of gas	Failure of FCV 244 or any elements of the control system to open more and or more opening of adjustable choke valve	Possibility of damage to the flow lines and downstream equipment due to over pressure
14	1	As well as	Flow	Leakage/rupture	Corrosion, erosion, aging, gasket failure, ring failure, insulating joint failure, thermal tension, etc.	Toxic gas release, risk of personnel injury, loss of material, the environmental pollution and loss of production
15	1	As well as	Flow	Leakage/rupture	Corrosion, erosion, aging, gasket failure, ring failure, insulating joint failure, TPD, thermal tension, etc.	Risk of reverse flow
16	1	Other than	Operation	Fire case	Ignition of released gas	Damage to facilities
17	1	Other than	Operation	Well blowout	Failure of Christmas Tree due to any reason.	Toxic gas release to atmosphere.
18	2	No/less	Flow	No/less flow of the corrosion inhibitor	Closure of manual valve on pump discharge by error	Damage to pump and thus the environmental pollution
19	2	High	Level	High level	More filling of tank by error or failure of LG	Overfilling of inhibitor, and thus the environmental pollution
20	2	Low	Level	Low level	Consumption and not refilling by failure	Possibility of damage to pump and also flow cut off in the flow lines
21	3	High	Pressure	High pressure	Failure of PCV 350 on burn pit ignition system to open more	Improper ratio of fuel/air, leading to not burning of the pilot
22	3	High	Pressure	High pressure	Failure of PCV 330 on flare ignition system to open more	Improper ratio of fuel/air, leading to not burning of the pilot
23	3	High	Pressure	High pressure	Failure of PCV 334 on flare/ burn pit pilot gas to open more	Loss of gas
24	3	High	Level	High level	Not draining liquids in proper time by error or by failure of level indication system (level control system in flare K.O Drum has been changed from automatic to manual).	Accumulation of liquid, overflow to flare header and damage to flare stack, flaming rain, and the risk of the environmental pollution and personnel injury
25	3	Low	Level	Low level	Operator failure to close drain valve in proper time	Possibility of purge gas/sour gas blow-by to burn pit and thus uncontrolled burning and toxic dispersion
26	3	Other than	Operation	Loss of performance	Failure of PCV 334 on flare/burn pit pilot gas to close more	Loss of pilot gas and possibility of venting of unburned relief gas and dispersion of flammable and toxic gas
27	3	Other than	Operation	Loss of performance	Flame out condition due to any reason	Loss of pilot gas and possibility of venting of unburned relief gas and dispersion of flammable and toxic gas to area

Hazard No.	Node	guideword	Parameter	Deviation	Causes	Consequences
28	3	Other than	Operation	Loss of performance	Failure of PCV 330 on flare ignition system to close more	Delay in ignition
29	3	Other than	Operation	Loss of performance	Failure of PCV 350 on burn pit ignition system to close	Delay in ignition
30	3	Other than	Operation	Loss of performance	Failure of flame front ignitor system	Delay in ignition
31	3	Other than	Operation	Corrosion	Corrosive environment in K.O drum	Damage to K.O Drum and risk of fire, the environment pollution, toxic gas release and risk of personnel injury
32	4	High	Pressure	High pressure	Thermal expansion during box-up or fire case	Damage to pig barrels and facilities due to over pressure
33	4	Other than	Operation	Pig receiver problems	Failure of PCV 283 to open more. (In current condition, the PCV 283 is used as a manually operated valve).	Regarding to PCV 283 is fully open during pigging operation so no major issue of concern is identified
34	4	Other than	Operation	Pig receiver problems	Failure of PCV 283 to close more	Stopping pigging operation
35	4	Other than	Operation	Pig receiver problems	Failure of PCV 283 to close more	During emergency shutdown, flow lines will not depressurize properly (while MOV 256 and MOV 255A open simultaneously)
36	4	Other than	Operation	Pig receiver problems	Opening of Pig Receiver door when it is pressurized	Possibility of personnel injury due to toxic gas release
37	4	Other than	Operation	Pig receiver problems	Opening of Pig Receiver door when it is pressurized	Fire
38	4	Other than	Operation	Corrosion	Corrosive environment in Barrel	Damage to Barrel and the risk of fire, the environment pollution, toxic gas release and risk of personnel injury
39	4	Other than	Operation	Isolation	Any lines that are out of service	Risk of fire, the environment pollution, toxic gas release and risk of personnel injury
40	5	No/Less	Flow	No/less flow of gas	Decreased/cut-off of flow from upstream	Loss of production
41	5	No/Less	Flow	No/less flow of gas	Closure of MOV 208 and or Closure of MOV 221/222 by error	Loss of production
42	5	No/Less	Flow	No/less flow of gas	Closure of MOV 208 and or Closure of MOV 221/222 by error	Increase pressure upstream of the valve and possibility of damage to relevant well flowline due to over pressure and the risk of relevant well trip.
43	5	No/Less	Flow	No/less flow of gas	Closure of MOV 317/417 by error	Loss of production
44	5	No/Less	Flow	No/less flow of gas	Closure of MOV 317/417 by error	Increased pressure upstream of the valve and possibility of damage to the flow lines due to over pressure and risk of well trips
45	5	No/Less	Flow	No/less flow of gas	Not receiving in downstream	Loss of production
46	5	No/Less	Flow	No/less flow of gas	Not receiving in downstream	Increased pressure and possibility of damage to relevant facility
47	5	High	Pressure	High pressure	Thermal expansion during box-up or fire case	Possibility of damage to line and equipment due to over pressure
48	5	High	Pressure	High pressure	Hold-up in pipeline	Back pressure for upstream facility and wellhead
49	5	Other than	Operation	Leakage/rupture	Corrosion, erosion, aging, gasket failure, ring failure, insulating joint failure, TPD, thermal tension, etc.	Toxic gas release, risk of personnel injury, loss of material, the environmental pollution and loss of production
50	5	Other than	Operation	Fire case	Ignition of released gas	Damage to facilities

- 1 Using Tables 2 and 3 to determine the frequency and the severity of the hazards in the conventional
- 2 HAZOP, the risks ranked by the risk matrix in Fig. 3 are listed in Table 10.
- 3

**Table 10:** Risks ranked using the risk matrix in conventional HAZOP.

Hazard No.	Judgment		Risk category	Rank No.
	F	S		
1	3	1	IV	15
2	3	1	IV	15
3	1	1	IV	15
4	1	1	IV	15
5	3	1	IV	15
6	3	1	IV	15
7	1	4	III	4
8	1	1	IV	15
9	3	1	IV	15
10	1	1	IV	15
11	2	2	IV	15
12	1	4	III	4
13	1	1	IV	15
14	2	2	IV	15
15	1	4	III	4
16	1	4	III	4
17	1	4	III	4
18	1	1	IV	15
19	2	1	IV	15
20	2	1	IV	15
21	3	1	IV	15
22	3	1	IV	15
23	3	1	IV	15
24	2	2	IV	15
25	2	2	IV	15
26	2	2	IV	15
27	2	2	IV	15
28	2	1	IV	15
29	2	1	IV	15
30	2	1	IV	15
31	2	2	IV	15
32	1	1	IV	15
33	2	1	IV	15
34	2	1	IV	15
35	2	1	IV	15
36	2	4	II	1
37	1	4	III	4
38	2	4	II	1
39	1	2	IV	15
40	2	1	IV	15
41	2	1	IV	15
42	1	4	III	4
43	2	1	IV	15
44	1	4	III	4
45	2	1	IV	15
46	1	4	III	4
47	1	4	III	4
48	3	1	IV	15
49	2	4	II	1

Hazard No.	Judgment		Risk category	Rank No.
	F	S		
50	1	4	III	4

1 **4.2. FMA-HAZOP analysis**

2 To rank the identified hazards by FMA-HAZOP, Table 5 is first used to develop the comparison matrix to  
3 determine the weight of the risk factors. Table 11 shows the results of pairwise comparison of the risk  
4 factors, with a CR = 0.017 which is way below the maximum threshold of 0.1. Table 12 presents the  
5 relative weight of the risk factors calculated by the fuzzy AHP. Table 7 is used for evaluation of risk  
6 factors in the FMA-HAZOP. As can be seen from Table 12, for the case study of interest, the frequency and  
7 the severity have the largest impact whereas the sensitivity to maintenance has the smallest impact on  
8 the risk. The identified hazards can be ranked as in Table 13 based on the calculated closeness  
9 coefficients by fuzzy TOPSIS.

10

11

**Table 11:** Pairwise comparisons matrix for risk factors.

Risk factors	F	S	U	SSM	SM
F	(1,1,1)	(1,1,1)	$(\frac{3}{2}, 2, \frac{5}{2})$	$(\frac{3}{2}, 2, \frac{5}{2})$	$(\frac{5}{2}, 3, \frac{7}{2})$
S	(1,1,1)	(1,1,1)	$(\frac{3}{2}, 2, \frac{5}{2})$	$(\frac{3}{2}, 2, \frac{5}{2})$	$(\frac{5}{2}, 3, \frac{7}{2})$
U	$(\frac{2}{5}, \frac{1}{2}, \frac{2}{3})$	$(\frac{2}{5}, \frac{1}{2}, \frac{2}{3})$	(1,1,1)	(1,1,1)	$(1, \frac{3}{2}, 2)$
SSM	$(\frac{2}{5}, \frac{1}{2}, \frac{2}{3})$	$(\frac{2}{5}, \frac{1}{2}, \frac{2}{3})$	(1,1,1)	(1,1,1)	$(1, \frac{3}{2}, 2)$
SM	$(\frac{2}{7}, \frac{1}{3}, \frac{2}{5})$	$(\frac{2}{7}, \frac{1}{3}, \frac{2}{5})$	$(\frac{1}{2}, \frac{2}{3}, 1)$	$(\frac{1}{2}, \frac{2}{3}, 1)$	(1, 1, 1)

**Table 12:** Relative weight of risk factors.

Risk factors	F	S	U	SSM	SM
Weight	0.2599	0.2599	0.1785	0.1785	0.1231

12

**Table 13:** Risk ranking by FMA-HAZOP.

Hazard No.	Judgment					Closeness coefficient (cc <sub>i</sub> )	Rank No.
	F	S	U	SSM	SM		
1	MH	VL	FA	FA	HI	0.1004	24
2	HI	VL	FA	FA	MH	0.1047	22
3	NE	VL	FA	NE	VL	0.0386	50
4	VL	VL	FA	VL	LO	0.0493	48
5	MH	VL	ML	FA	HI	0.0954	25
6	FA	VL	ML	ML	FA	0.0782	33
7	LO	VH	FA	MH	FA	0.1099	17

Hazard No.	Judgment					Closeness coefficient (cc <sub>i</sub> )	Rank No.
	F	S	U	SSM	SM		
8	NE	NE	HI	NE	VL	0.0445	49
9	HI	LO	FA	ML	HI	0.1090	19
10	VL	LO	FA	ML	LO	0.0616	45
11	ML	FA	FA	FA	HI	0.1021	23
12	VL	AH	HI	HI	LO	0.1172	11
13	VL	VL	FA	MH	HI	0.0762	36
14	FA	FA	HI	VH	VH	0.1342	4
15	VL	VH	HI	ML	VH	0.1148	14
16	LO	VH	HI	HI	VH	0.1330	5
17	VL	MA	FA	MA	VH	0.1363	3
18	VL	ML	FA	MH	ML	0.0777	34
19	ML	LO	LO	FA	FA	0.0751	37
20	ML	ML	FA	MH	FA	0.0943	27
21	MH	NE	FA	VL	HI	0.0852	30
22	MH	VL	FA	VL	HI	0.0893	29
23	MH	VL	FA	LO	HI	0.0928	28
24	FA	FA	MH	MH	ML	0.1092	18
25	FA	ML	MH	VH	VL	0.1057	20
26	ML	FA	HI	MH	HI	0.1160	12
27	ML	FA	HI	MH	FA	0.1100	16
28	LO	VL	FA	LO	HI	0.0712	41
29	ML	VL	FA	ML	HI	0.0820	31
30	LO	VL	FA	LO	FA	0.0652	44
31	FA	FA	HI	MH	VH	0.1263	8
32	VL	LO	FA	MH	ML	0.0722	39
33	LO	NE	FA	VL	LO	0.0517	46
34	LO	NE	FA	VL	LO	0.0517	46
35	LO	LO	FA	ML	LO	0.0681	43
36	FA	VH	FA	HI	MH	0.1312	6
37	LO	VH	FA	ML	MH	0.1052	21
38	ML	VH	FA	HI	VH	0.1301	7
39	VL	FA	FA	MH	VL	0.0777	35
40	ML	VL	FA	LO	FA	0.0722	40
41	ML	VL	FA	FA	FA	0.0798	32
42	LO	VH	ML	VH	MH	0.1158	13
43	ML	LO	ML	LO	FA	0.0723	38
44	LO	AH	ML	VH	MH	0.1216	10
45	ML	LO	ML	VL	FA	0.0688	42
46	LO	AH	ML	HI	FA	0.1146	15
47	VL	AH	HI	VH	ML	0.1240	9
48	MH	LO	ML	MH	ML	0.0954	26
49	FA	AH	HI	AH	VH	0.1610	1
50	LO	AH	HI	HI	VH	0.1388	2

1

2 **4.3. Comparison between HAZOP and FMA-HAZOP**

3 50 hazards were identified using the conventional HAZOP analysis for the gas wellhead facility (Table 9).

4 Safety is very critical for gas wellhead facilities, and thus, as expected, there is no hazard in Category I and

5 only 6% of the hazards in Category II that should be mitigated to the lower categories (hazard numbers

6 49, 36, 38). Likewise, 22% of the hazards are in Category III, which require controlling procedures and

7 mitigating actions, and 72% of the hazards are in Category IV with no need for further prevention or

1 mitigation measures. Hazards rankings identified using both the conventional HAZOP and FMA-HAZOP  
 2 are shown in Fig. 5. As can be noted, compared to the conventional HAZOP, FMA-HAZOP has resulted in  
 3 more distinguished ranks for the hazards, which in turn facilitates the allocation of risk-reduction  
 4 measures under limited resources (budget, time, etc.).

5

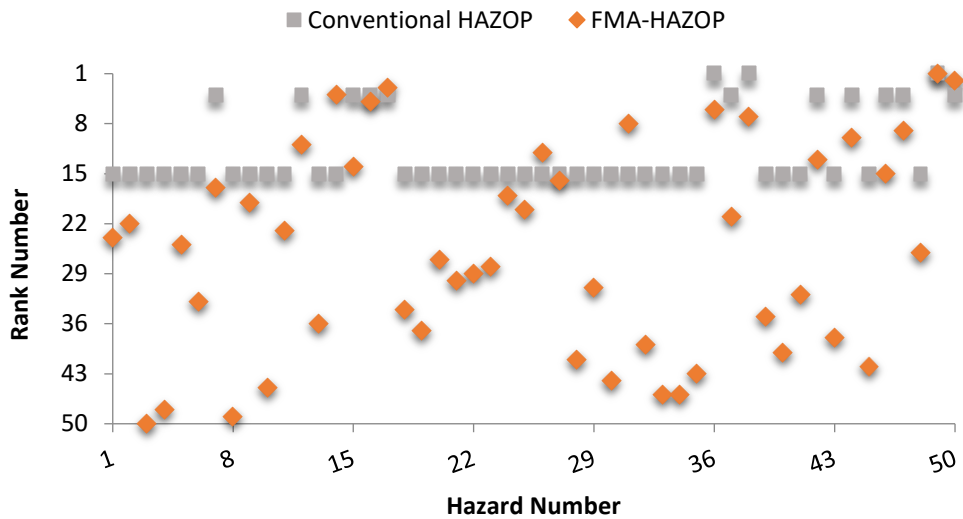

6

**Fig. 7.** Hazards ranking in conventional HAZOP and FMA-HAZOP.

7 Release of toxic chemicals is one of the frequent hazards in the process facilities as in the Seveso and  
 8 Bhopal disasters (Lees 2012). Comparing the results of conventional HAZAOP and FMA-HAZOP (Tables  
 9 10 and 12), the hazards 36, 38 and 49 are ranked as the top three hazards using conventional HAZOP  
 10 whereas when using FMA-HAZOP the top three hazards are identified as the hazards 49, 50, and 17.  
 11 Hazard 49, release of toxic gas in header and trunk line, which can be actualized by using low-grade  
 12 gaskets, poor inspection of pipelines coating, and insufficient repair with proper coating, has a “fair”  
 13 frequency and an “absolutely high” severity. Due to some reasons such as the absence of hydrogen sulfide  
 14 gas detector, the un-detectability of this hazard is “high”. This hazard is also “very highly” sensitive to the  
 15 regular inspection and maintenance the failure of which could increase the frequency of release of toxic  
 16 gas. The failure of respective safety measures such as cathodic protection, PSL, corrosion inhibitor  
 17 injection due to poor safety management, inadequate training, and poor safety culture could highly  
 18 impact the frequency of this hazard, resulting in a “absolutely high” SSM.

1 Explosion and fire caused by the ignition of released flammable chemicals is one of the significant hazards  
2 in the process plants (Lees 2012). Hazard 50, the ignition of released flammable gas in header and trunk  
3 line, is the 2<sup>nd</sup> top hazard according to the results of FMA-HAZOP whereas according to the results of  
4 HAZOP this hazard along with nine other hazards are ranked in the fourth place. In other words, using the  
5 three additional risk factors U, SM and SSM in FMA-HAZOP has helped differentiate among the hazards.  
6 Hazard 17, i.e., the third top hazard in FMA-HAZOP and the fourth top hazard in HAZOP is the well blowout.  
7 Well blowout is one of the most undesired and expensive accident in the oil and gas facilities (Khakzad et  
8 al., 2013), and extremely sensitive to the failure of safety measures such as SSSV, training and annulus  
9 pressure management (Zhang et al. 2018).  
10 Thus, in FMA-HAZOP, hazards with higher sensitivity to failure of safety measures (e.g., hazards 14, 16, 17  
11 and 50) take higher ranks compared to those in the conventional HAZOP. Likewise, hazards with higher  
12 sensitivity to maintenance (e.g., hazards 14, 16, 17 and 50) take higher ranks compared to those in the  
13 conventional HAZOP.

## 14 **5. Conclusions**

15 In the present study, we developed FMA-HAZOP to alleviate the limitations of the conventional HAZOP by  
16 (i) incorporating more risk factors, that is, un-detectability, sensitivity to failure of safety measures, and  
17 sensitivity to maintenance effectiveness, than just the frequency and the severity of hazards, (ii) dealing  
18 with uncertainty about the degree of the risk factors via fuzzy set theory, and (iii) differentiating among  
19 the importance of the risk factors via multi-attribute decision making techniques such as AHP and  
20 TOPSIS.

21 Applying both the conventional HAZOP and FMA-HAZOP to a gas wellhead facility, it was demonstrated  
22 that FMA-HAZOP outperforms the conventional HAZOP although it is more time-consuming. FMA-HAZOP  
23 provides more information to safety managers about the hazards and their rankings, and thus facilitates  
24 the layout of more effective safety management strategies by narrowing the number of critical hazards.

## 25 **References**

- 26 Adams, N. and M. Makvandi (2007). "Controlling the Well 23 blowout in Iran's Kangan field." World Oil  
27 **228**(1): 41-44.
- 28 Ahn, J. and D. Chang (2016). "Fuzzy-based HAZOP study for process industry." Journal of Hazardous  
29 Materials **317**: 303-311.

- 1 Akyildiz, H. and A. Mentis (2017). "An integrated risk assessment based on uncertainty analysis for cargo  
2 vessel safety." Safety science **92**: 34-43.
- 3 Alkhalidi, M., C. Pathirage and U. Kulatunga (2017). The role of human error in accidents within oil and gas  
4 industry in Bahrain. 13th International Postgraduate Research Conference (IPGRC): conference  
5 proceedings, University of Salford.
- 6 Aras, F., E. Karakaş and Y. Biçen (2014). "Fuzzy logic-based user interface design for risk assessment  
7 considering human factor: A case study for high-voltage cell." Safety science **70**: 387-396.
- 8 Ataallahi, E. and S. R. Shadizadeh (2015). "Fuzzy consequence modeling of blowouts in Iranian drilling  
9 operations; HSE consideration." Safety Science **77**: 152-159.
- 10 Aziz, H. A., M. R. Othman, A. M. Shariff and L. S. Tan (2017). "Application of analytical hierarchy process  
11 (AHP) in prioritizing HAZOP analysis for pilot plant." Chemical Engineering Research Bulletin **19**:  
12 87-95.
- 13 Biyikli, O. and E. K. Aydogan (2016). "A new model suggestion to estimate the proba- bility valuein  
14 occupational health and safetyrisk assessment." Ap- plied Mathematics & Information Sciences **10**(2):  
15 663.
- 16 Brandsæter, A. (2002). "Risk assessment in the offshore industry." Safety Science **40**(1): 231-269.
- 17 Carpitella, S., A. Certa, J. Izquierdo and C. M. La Fata (2018). "A combined multi-criteria approach to support  
18 FMECA analyses: A real-world case." Reliability Engineering & System Safety **169**: 394-402.
- 19 CCPS (2010). Guidelines for Hazard Evaluation Procedures, Third Edition, Center for Chemical Process Safety,  
20 Wiley.
- 21 Chang, D.-Y. (1996). "Applications of the extent analysis method on fuzzy AHP." European journal of  
22 operational research **95**(3): 649-655.
- 23 Chen, C.-T. (2000). "Extensions of the TOPSIS for group decision-making under fuzzy environment." Fuzzy  
24 sets and systems **114**(1): 1-9.
- 25 Cheraghi, M., A. Bagherian-Sahlavani and I. Mohammad Fam (2018). "Toxic Chemical Release Hazard  
26 Distance Determination Using Chemical Exposure Index (CEI) in a Gas Refinery." Iranian Journal of  
27 Chemistry and Chemical Engineering (IJCCE).
- 28 Devold, H. (2013). Oil and gas production handbook: an introduction to oil and gas production, Lulu. com.



1 Djapan, M., I. Macuzic, D. Tadic and G. Baldissonne (2018). "An innovative prognostic risk assessment tool for  
2 manufacturing sector based on the management of the human, organizational and  
3 technical/technological factors." Safety Science.

4 Dunj3, J., V. Fthenakis, J. A. V3lchez and J. Arnaldos (2010). "Hazard and operability (HAZOP) analysis. A  
5 literature review." Journal of Hazardous Materials **173**(1): 19-32.

6 Fuentes-Bargues, J. L., C. Gonz3lez-Gaya, M. C. Gonz3lez-Cruz and V. Cabrelles-Ram3rez (2016). "Risk  
7 assessment of a compound feed process based on HAZOP analysis and linguistic terms." Journal of  
8 Loss Prevention in the Process Industries **44**: 44-52.

9 Gao, T.-t. and S.-m. Wang (2018). "Fuzzy Integrated Evaluation Based on HAZOP." Procedia engineering **211**:  
10 176-182.

11 Grassi, A., R. Gamberini, C. Mora and B. Rimini (2009). "A fuzzy multi-attribute model for risk evaluation in  
12 workplaces." Safety Science **47**(5): 707-716.

13 Gul, M. and A. F. Guneri (2016). "A fuzzy multi criteria risk assessment based on decision matrix technique: a  
14 case study for aluminum industry." Journal of Loss Prevention in the Process Industries **40**: 89-100.

15 Guo, Y., X. Meng, T. Meng, D. Wang and S. Liu (2016). "A novel method of risk assessment based on cloud  
16 inference for natural gas pipelines." Journal of Natural Gas Science and Engineering **30**(Supplement  
17 C): 421-429.

18 G3rcanlı, G. E. and U. M3ngen (2009). "An occupational safety risk analysis method at construction sites using  
19 fuzzy sets." International Journal of Industrial Ergonomics **39**(2): 371-387.

20 Hatami-Marbini, A., M. Tavana, M. Moradi and F. Kangi (2013). "A fuzzy group Electre method for safety and  
21 health assessment in hazardous waste recycling facilities." Safety science **51**(1): 414-426.

22 HU, J.-q., L.-b. ZHANG, W. LIANG and Z.-h. WANG (2009). "Quantitative HAZOP analysis for gas turbine  
23 compressor based on fuzzy information fusion." Systems Engineering-Theory & Practice **29**(8): 153-  
24 159.

25 Hwang, C.-L. and K. Yoon (1981). Methods for Multiple Attribute Decision Making. Multiple Attribute  
26 Decision Making: Methods and Applications A State-of-the-Art Survey. Berlin, Heidelberg, Springer  
27 Berlin Heidelberg: 58-191.

28 IEC:61882 (2001). "Hazard and operability studies (HAZOP studies)—Application guide." International  
29 Electrotechnical Commission.

- 1 Jamshidi, A., A. Yazdani-Chamzini, S. H. Yakhchali and S. Khaleghi (2013). "Developing a new fuzzy  
2 inference system for pipeline risk assessment." Journal of loss prevention in the process industries  
3 **26**(1): 197-208.
- 4 Kang, J., L. Guo and N. Wang (2015). "Simplified HAZOP analysis based on fuzzy evaluation of node  
5 criticality for chemical plants." Open Cybernetics and Systemics Journal **9**: 01-06.
- 6 Kang, J., J. Zhang and J. Gao (2016). "Analysis of the safety barrier function: Accidents caused by the failure of  
7 safety barriers and quantitative evaluation of their performance." Journal of Loss Prevention in the  
8 Process Industries **43**: 361-371.
- 9 Khakzad N, Khan F, Amyotte P. (2011). Safety analysis in process facilities: Comparison of fault tree and  
10 Bayesian network approaches. Reliability Engineering & System Safety **96**(8): 925-932.
- 11 Khakzad, N., F. Khan and P. Amyotte (2013). "Quantitative risk analysis of offshore drilling operations: A  
12 Bayesian approach." Safety Science **57**: 108-117.
- 13 Kokangül, A., U. Polat and C. Dağsuyu (2017). "A new approximation for risk assessment using the AHP and  
14 Fine Kinney methodologies." Safety science **91**: 24-32.
- 15 Lavasani, S. M., N. Ramzali, F. Sabzalipour and E. Akyuz (2015). "Utilisation of Fuzzy Fault Tree Analysis  
16 (FFTA) for quantified risk analysis of leakage in abandoned oil and natural-gas wells." Ocean  
17 Engineering **108**: 729-737.
- 18 Lavasani, S. M., Z. Yang, J. Finlay and J. Wang (2011). "Fuzzy risk assessment of oil and gas offshore wells."  
19 Process Safety and Environmental Protection **89**(5): 277-294.
- 20 Lees, F. (2012). Lees' Loss prevention in the process industries: Hazard identification, assessment and control,  
21 Butterworth-Heinemann.
- 22 Marhavidas, P.-K., D. Koulouriotis and V. Gemeni (2011). "Risk analysis and assessment methodologies in the  
23 work sites: On a review, classification and comparative study of the scientific literature of the period  
24 2000–2009." Journal of Loss Prevention in the Process Industries **24**(5): 477-523.
- 25 Markowski, A. S. and D. Siuta (2018). "Fuzzy logic approach for identifying representative accident scenarios."  
26 Journal of Loss Prevention in the Process Industries **56**: 414-423.
- 27 Mikulak, R. J., R. McDermott and M. Beauregard (2008). The basics of FMEA, CRC Press.
- 28 Murè, S. and M. Demichela (2009). "Fuzzy Application Procedure (FAP) for the risk assessment of  
29 occupational accidents." Journal of loss prevention in the process industries **22**(5): 593-599.

- 1 Nilsen, T. and T. Aven (2003). "Models and model uncertainty in the context of risk analysis." Reliability  
2 Engineering & System Safety **79**(3): 309-317.
- 3 O Herrera, M. A. d. I., A. S. Luna, A. C. A. d. Costa and E. M. B. Lemes (2018). "Risk Analysis: A generalized  
4 Hazop methodology state-of-the-art, applications, and perspective in the process industry."
- 5 Okoh, P. and S. Haugen (2013). "Maintenance-related major accidents: classification of causes and case study."  
6 Journal of Loss Prevention in the Process Industries **26**(6): 1060-1070.
- 7 Othman, M. R., R. Idris, M. H. Hassim and W. H. W. Ibrahim (2016). "Prioritizing HAZOP analysis using  
8 analytic hierarchy process (AHP)." Clean Technologies and Environmental Policy **18**(5): 1345-1360.
- 9 Pan, R. L., X. Y. Zhou and X. T. Lin (2012). The Assessment of Cylinder Liner by HAZOP Analysis and Fuzzy  
10 Comprehensive Evaluation. Advanced Materials Research, Trans Tech Publ.
- 11 Patil, S. K. and R. Kant (2014). "A fuzzy AHP-TOPSIS framework for ranking the solutions of Knowledge  
12 Management adoption in Supply Chain to overcome its barriers." Expert Systems with Applications  
13 **41**(2): 679-693.
- 14 Pinto, A. (2014). "QRAM a qualitative occupational safety risk assessment model for the construction industry  
15 that incorporate uncertainties by the use of fuzzy sets." Safety Science **63**: 57-76.
- 16 Raviv, G., A. Shapira and B. Fishbain (2017). "AHP-based analysis of the risk potential of safety incidents:  
17 Case study of cranes in the construction industry." Safety science **91**: 298-309.
- 18 Saaty, T. L. (1977). "A scaling method for priorities in hierarchical structures." Journal of mathematical  
19 psychology **15**(3): 234-281.
- 20 Saaty, T. L. (1980). The analytic hierarchy process. New York, MacGraw-Hill.
- 21 Sii, H. S., T. Ruxton and J. Wang (2001). "A fuzzy-logic-based approach to qualitative safety modelling for  
22 marine systems." Reliability Engineering & System Safety **73**(1): 19-34.
- 23 Standard, N. (2004). "Well integrity in drilling and well operations." D-010, rev 3.
- 24 Vinnem, J. E. (2018). "FPSO Cidade de São Mateus gas explosion – Lessons learned." Safety Science **101**: 295-  
25 304.
- 26 Wang, Q., H. Wang and Z. Qi (2016). "An application of nonlinear fuzzy analytic hierarchy process in safety  
27 evaluation of coal mine." Safety science **86**: 78-87.
- 28 Wei, L., Z. Laibin and H. Jinqiu (2009). Fuzzy information fusion based quantitative HAZOP analysis for gas  
29 compressor units. Intelligent Systems, 2009. GCIS'09. WRI Global Congress on, IEEE.
- 30 Zadeh, L. A. (1965). "Fuzzy sets." Information and control **8**(3): 338-353.

- 1 Zhang, N., Z. Zhang, Z. Rui, J. Li, C. Zhang, Q. Zhang, W. Zhao and S. Patil (2018). "Comprehensive risk
- 2 assessment of high sulfur-containing gas well." Journal of Petroleum Science and Engineering **170**:
- 3 888-897.
- 4 Zhou, Q., Y. D. Wong, H. Xu, V. Van Thai, H. S. Loh and K. F. Yuen (2017). "An enhanced CREAM with
- 5 stakeholder-graded protocols for tanker shipping safety application." Safety science **95**: 140-147.
- 6 Zimmermann, H.-J. (2011). Fuzzy set theory—and its applications, Springer Science & Business Media.