

**Serious Gaming in Augmented Reality using HMDs for Assessment of Upper Extremity Motor Dysfunctions
User Studies for Engagement and Usability**

Cidota, Marina; Lukosch, Stephan; Dezentje, P; Bank, PJM; Lukosch, Heide; Clifford, RMS

DOI

[10.1515/icom-2016-0020](https://doi.org/10.1515/icom-2016-0020)

Publication date

2016

Document Version

Final published version

Published in

i-com Journal of Interactive Media

Citation (APA)

Cidota, M., Lukosch, S., Dezentje, P., Bank, PJM., Lukosch, H., & Clifford, RMS. (2016). Serious Gaming in Augmented Reality using HMDs for Assessment of Upper Extremity Motor Dysfunctions: User Studies for Engagement and Usability. *i-com Journal of Interactive Media*, 15(2), 155-169. <https://doi.org/10.1515/icom-2016-0020>

Important note

To cite this publication, please use the final published version (if applicable).
Please check the document version above.

Copyright

Other than for strictly personal use, it is not permitted to download, forward or distribute the text or part of it, without the consent of the author(s) and/or copyright holder(s), unless the work is under an open content license such as Creative Commons.

Takedown policy

Please contact us and provide details if you believe this document breaches copyrights.
We will remove access to the work immediately and investigate your claim.

Research Article

Marina A. Cidota*, Stephan G. Lukosch, Paul Dezentje, Paulina J. M. Bank, Heide K. Lukosch, Rory M. S. Clifford

Serious Gaming in Augmented Reality using HMDs for Assessment of Upper Extremity Motor Dysfunctions

User Studies for Engagement and Usability

DOI 10.1515/icom-2016-0020

Abstract: For a better understanding of how different disorders affect motor function, a uniform, standardized and objective evaluation is a desirable goal for the clinical community. We explore the potential of Augmented Reality (AR) combined with serious gaming and free hand tracking to facilitate objective, cost-effective and patient-friendly methods for evaluation of upper extremity motor dysfunction in different patient groups. In this paper, we describe the design process of the game and the system architecture of the AR framework to meet these requirements. Furthermore, we report our findings from two pilot studies we conducted with healthy people aged over 50. First, we present a usability study ($n=5$) on three different modalities of visual feedback for natural hand interaction with AR objects (i. e., no augmented hand, partial augmented hand and a full augmented hand model). The results show that a virtual representation of the fingertips or hand improves the usability of natural hand interaction. Secondly, a study about game engagement is presented. The results of this experiment ($n=8$) show that there might be potential for engagement, but usability needs to be improved before it can emerge.

Keywords: Augmented Reality, Optical See-Through HMD, Natural Hand Interaction, Serious Gaming, Engagement, Upper Extremity Motor Dysfunction, Assessment

*Corresponding author: Marina A. Cidota, Delft University of Technology, Delft, The Netherlands, e-mail: m.a.cidota@tudelft.nl

Stephan G. Lukosch, Delft University of Technology, Delft, The Netherlands, e-mail: s.g.lukosch@tudelft.nl

Paul Dezentje, Delft University of Technology, Delft, The Netherlands, e-mail: pauldezentje80@gmail.com

Paulina J. M. Bank, Leiden University Medical Center, Leiden, The Netherlands, e-mail: p.j.m.bank@lumc.nl

Heide K. Lukosch, Delft University of Technology, Delft, The Netherlands, e-mail: h.k.lukosch@tudelft.nl

Rory M. S. Clifford, Human Interface Technology Laboratory, University of Canterbury, Christchurch, New Zealand, e-mail: rory.clifford@pg.canterbury.ac.nz

1 Introduction

In an aging society, more and more people are affected by disorders that impair the motor function, e. g. neurovascular diseases, neurodegenerative diseases, and musculoskeletal pain conditions. These disorders have considerable impact on mobility and manual function, which in turn may affect self-dependence and the ability to work and recreate, and may ultimately result in the loss of quality of life [23, 25]. Developing cost-effective, objective, quantitative and valid evaluation methods in diagnosis, treatment and monitoring of patients with motor dysfunctions is one goal to guarantee a well-functioning health care system in an aging society. In addition to being relevant from the clinical perspective, these methods should also be patient-friendly, i. e. easy to use, unobtrusive and engaging for the patient.

Currently, every medical discipline uses its own (disease-specific) clinical tests, which mostly involve subjectively scored, low-resolution (i. e. insensitive) clinimetric assessments focusing on either “body functions and structures” (e. g. range of motion (ROM), stiffness) or “activities” (e. g. ability to perform functional tasks like grasping an object or pouring water into a glass within a prescribed time). Other assessment protocols are based on qualitative video analysis or cumbersome marker-based motion capturing. Although being essential aspects of daily life, variations in task and environment are often not considered.

In this paper, we explore the capabilities of AR technology using Optical See-Through (OST) head-mounted devices (HMDs) for displaying virtual content and free hand tracking to implement an engaging tool that may contribute to the development of a uniform standard procedure to assess upper extremity motor dysfunctions. We use an OST-HMD for the patients’ safety, especially for future situations when they will be asked to walk with the HMD during exercises.

For meaningful assessment of upper extremity motor dysfunction, a natural way of interacting with virtual

content is of high importance for obtaining insight into impairments encountered in daily life conditions. The most natural method of interaction with AR devices can be achieved by means of hand gesture recognition [32]. The ability to track hands has been addressed in previous studies for Video See-Through (VST) HMDs [15], where the user's hands are displayed through the RGB camera, combined with any virtual content. The alternative approach using OST-HMDs, however, provides a different set of problems, since the user's hands are directly visible and thus exist in both virtual and real spaces.

When using an OST-HMD, we therefore have to take into account the alignment between the virtual augmented world and the real world. We first aimed to investigate what properties of the virtual content provide the best user experience for natural hand interaction in OST-HMD AR. We explore interaction modalities for flexible, patient-tailored assessment that may motivate patients to use their affected upper extremity to its full capability, ultimately leading to better insight into motor dysfunction [10]. Also, in order to obtain feedback on the game design and implementation, we conducted a second user study on game engagement [12].

The experiments described in our paper are one of many steps in the development of a system for assessing upper extremity motor dysfunctions in various patient groups. We tested the system with healthy people, as we first wanted to be sure that it can be operated effectively by a person who does not have a motor dysfunction, without inducing any adverse effects by the system. If a healthy person would not be able to use the system, then a person with motor dysfunction would also struggle to use it and the system would not provide meaningful data. We consider that the results of the current experiments are valuable in the context of the intended medical application, as input for further development of the system and for tests with patients.

Section 2 of this paper presents related work. In Section 3 we describe the design of the game that we intend to use for evaluating motor dysfunctions. Section 4 presents the system architecture and software components, followed by the results of two user studies in Section 5. The paper closes with conclusions and future work.

2 Related Work

Virtual Reality (VR) has already proved to offer great opportunities for diagnosis and treatment of several patient groups. Broeren et al. [7], for example, use a

haptic feedback device in combination with VR to assess upper extremity motor dysfunction as a result of a stroke. They show that their system has potential to be used for clinical assessments. Burke et al. [9] use serious games in virtual worlds to foster engagement in intensive and repetitive post-stroke rehabilitation tasks. Similarly, Taske et al. [30] present the design of motor rehabilitation program for stroke patients that uses mini-games in VR to motivate patients. Barros et al. [4] provide a survey on recent research with regard to the use of VR for different medical purposes: training aimed at improving the gait pattern in patients with Parkinson's disease; helping to improve spatial perception in children with cerebral palsy; post-operative treatment of patients who suffered surgeries of the hand and rehabilitation of stroke patients. Barros et al. [4] conclude that VR enables real-world situations to be simulated, thereby giving the therapist full control over the variables related to the health aspects of interest.

Although VR is an excellent tool for several purposes, we consider that the total visual isolation from the real world may be a drawback for evaluation of functional activities involving the upper extremity. With the patient being immersed in a completely fabricated environment and having only mediated visual experiences, interference with natural behaviour is expected to happen. Moreover, it may become a serious problem when the patient is required to interact with the clinician or with a real object.

This issue can be circumvented by using AR technology, where virtual data is spatially overlaid on top of physical reality, e. g. by means of a projector, a tablet, a monitor or a HMD. In doing so, AR uses the flexibility of VR while grounding it in physical reality [3] and thus, it provides patients with a more realistic experience that results in more intuitive natural interaction [16].

Botella et al. [6] developed an AR system in which people with a cockroach phobia are shown cockroaches moving through the room. By letting the cockroaches move realistically through the room and allowing them to be killed if the patient touches them, the virtual elements allow the player to be engaged by the environment, enhancing the effect of the treatment. Showing an image of the cockroach only would have lesser effect and highlight by this the importance of patient engagement.

Alamri et al. [2] developed a framework for AR rehabilitation games using haptic feedback. In this framework, they describe two exercises: a shelf exercise where the patient has to remove a virtual object from a shelf and place it somewhere else, and a cup exercise where the patient has to follow a specific path with the cup. Both exercises focus on normal daily activities that are

measured. They measure the task-completion time of horizontal movement, vertical movement and following the guiding axis.

Khademi et al. [21] describe the use of haptic devices to measure the human arm's impedance. With the input from a RGB camera and a smart mug, the system generates appropriate impedance graphs that are not only displayed on a laptop screen in real time, but are also projected on the patient's hand (using a projector). The system can help improve the rehabilitation of patients because it would allow them to train without a therapist.

Hondori et al. [16] describe a spatial AR system for the rehabilitation of hand and arm movement, using a projector for augmenting two-dimensional content on the table surface and a webcam to locate and track the hand of the participant based on coloured markers detection and motion information.

Smeddinck et al. [29] combined AR with gaming for "full-body motion-based games for health" used in therapy and rehabilitation. They found that immersion has a big impact on the effect of the games but could not decide which of the three games is better because their results did not show preference towards any system. The study still shows that facilitating engagement will improve the effect of the game.

The above review of related work shows the potential of virtual and augmented reality for motor function rehabilitation or for treating phobias and the importance of creating an engaging environment. Still, none of the above approaches though has used AR and gaming for assessing human motor function.

3 Game Design

Part of developing a patient-friendly product capable of assisting therapists in the assessment of upper extremity motion disorders, is to design a game that entices patients to make the necessary movements, pushing them to the limit of their capabilities and provides the clinician with relevant objective and quantitative information. A game that engages players to participate is a strong tool that may transform repetition into a more pleasant activity [13, 14]. Burke et al. [9] and Taske et al. [30] have shown the positive effect of games in VR for motor rehabilitation. Like VR environments, AR game environments can be designed to encourage a person to become more motivated, as they can provide safe and customisable situations, which can be adapted to individual physical abilities [26]. Additionally, a game design can foster

so-called meaningful play, which describes the relationship between the process of play and the outcome from the system [28]. Immediate feedback from the game can be used to point out correct or incorrect actions. Clinical staff can gradually adapt the level of difficulty of the tasks a player has to accomplish in order to evaluate the motion ability of the player [9].

For the design process of the AR game, the design cycle of Meijer [24] for simulation games is used. To further define the design requirements, we consulted two groups of actors: clinicians and researchers on the one hand, and future players of the game on the other. First, the clinicians and researchers will use the system to perform the assessments. Because a motor dysfunction can be the result of various problems these clinicians come from different fields like neurology or rehabilitation [1]. The researchers specialized in human movement sciences have a lot of knowledge about various motor dysfunctions. Second, the future players of the game, namely the patients, are important for the design process. To be able to engage the target audience it is important to understand what their needs, interests and issues are. Other than age (older than 50), there are no more social or natural distinctions in the target audience. This means the sample groups should be chosen carefully so that, except for age, personal characteristics are spread out, not to bias the results.

3.1 Interviews with Clinicians

The primary goal of the game is its function as an assessment tool for different motion disorders. As the system needs to improve the quality of assessments, it is first important to understand how current assessments take place and why there is need for improvement. Therefore, two assessments were observed at Leiden University Medical Centre (LUMC). The assessments chosen were for two different disorders, Parkinson's disease and stroke, to create a broader view of the issues that the system should address. The clinicians performed the assessment as usual while explaining their thoughts and reasons behind each step made. After each assessment the researcher was given the opportunity to ask questions to both the patient and, after the patient left, the clinician. During these observations only notes were made out of respect of the patient's privacy. The notes of both observations were then analysed to determine the major requirements of an assessment.

Both of the observed assessments had a similar setup. First the clinician asked the patient how he was doing, giving him time to tell his own observations. Then the clinician asked the patient to make several movements

and observed these movements using a checklist with Likert scales as an analysis tool. The assessment of the stroke patient was focused on identifying the active range of motion of the limbs. The patient was asked to make several movements that tested each joint to its limits. In the cases that active movement was very difficult, the clinician moved the limbs to feel the tension and resistance in the joints.

Table 1: Functional movements.

#	Movement
1	Range of motion in individual joints
2	Reachable workspace
3	Pointing and reaching
4	Reach-and-grasp
5	Tremor assessment

The assessment of the Parkinson's disease patient was focused on identifying the speed, accuracy and amplitude of movements. Exercises like finger tapping on a table, repeatedly touching the thumb and index finger together and foot tapping were used to evaluate the severity of the disease. The patient was also asked to perform several movements to identify if the limbs froze upon initiation of a movement. The patient was also pulled out of balance to test how quickly he could stabilize again. Lastly, the clinician examined the presence or absence of tremor while the patient held his hands in a static position or a resting position, and while the patient performed a goal-directed movement.

The observed assessments showed us that clinicians want the patients to make movements to the limit of their capabilities. Only by measuring the limits of a patient's movements a proper assessment can be made.



Figure 1: Reachable workspace of the arm.

In the discussion afterwards, both clinicians indicated that a usual session takes between 30 and 60 minutes depending on the severity of the case. The clinicians also agreed that each type of assessment uses different motions which are specific for the symptoms of that motor dysfunction.

To further explain the current procedures and issues, the second study involved consulting an expert in movement sciences from LUMC. The consult focused on discussing questions found in the observations and to understand which movements are required to be incorporated in the game. The answers given by the expert were then compiled in a set of requirements for the game. Thus, we found that it would be best to focus on functional movements that are used in everyday life. These movements are not specific to particular symptoms. Instead it can be analysed what type of hinder the patient experiences during his normal routine. According to the expert, to perform a proper assessment the five motions shown in Table 1 should be measured.

The range of motion in individual joints means that the maximum flexion and extension in the fingers, wrist, elbow and shoulder should be examined. The reachable workspace is the space that the patient can reach by only moving the hands and arms and is determined for each arm. Figure 1 shows examples of reachable workspace of a person. Measuring pointing and reaching is done overhand and underhand as well as on the ipsilateral side and the contralateral side. The same applies for reaching and grasping plus that the patient has to perform several types of grips at various distances from the body. The tremor assessment is about measuring the frequency and amplitude of a possible tremor in the hands. This should be done during the mentioned functional movements and in a resting position. When the five types of measurements in Table 1 are combined in the game it will create enough input for an assessment.

3.2 Interviews with Patients

Our goal is to design engaging and easy-to-use games that stimulate the patients to perform the required tasks and even motivate them to do movements they would not do otherwise. A game is a suitable approach towards engagement, as it provides a so-called ‘magic circle’ [17, 22]. In this sense, a game takes place in a separate time and space, dedicated to a specific performance. The space of the magic circle is a social one, created by players, and governed by special rules [20]. The space of

a game consists of different components, like the physical, the temporal, or the psychological one. Different game components or elements can be used to address the engagement of a player. Benyon et al. [5] state engaging interactive systems need to be accessible, usable and acceptable that are concerned with the qualities of an experience, e.g. memorable, satisfying, enjoyable or rewarding, that pull people in. Engaging someone in a game is challenging as you have to tune it to a person’s preferences [31]. Of course, each individual is different thus it is important to find general preferences of the target audience. Ijsselsteijn et al. [19] mention the importance of understanding the motivations of the elderly, which overlaps with the target audience of the motion disorder game, arguing that further research on these motivations is necessary.

Dickey [13] suggests that for engagement a strategy has to be developed that fits game elements to the players preferences. As game elements Dickey [13] uses Rollings’ and Adams’ [27] five game dimensions as shown in Table 2, which refer to the components of the magic circle of a game.

Table 2: The five game dimensions [27].

Dimension	Explanation
The Physical dimension	The space in which the game takes place. This consists of dimensionality, scale and the boundaries of the space.
The Temporal dimension	The role of time in the game. Is there a continuous or discrete time flow? Is time anomalous? Can the player adjust time?
The Environmental dimension	The appearance, atmosphere and cultural context in the game.
The Emotional dimension	The emotions of the characters and the emotions intended to be invoked in the player
The Ethical dimension	The moral and ethics that consist in the game-world and the way these are presented to the player.

To understand how to engage the target audience, we decided to perform semi-structured interviews to identify the patients’ game requirements. Each interview was divided in two parts. The first five questions focused on the gaming history of the patient and the reasons for the choices he made in this regard (see Table 3). The second part focused on Rollings’ and Adams’ [27] five game dimensions and ask for necessary information to make the design.

Semi-structured interviews of about 30 to 45 minutes each were held with seven Parkinson’s disease patients at the neurology department of the LUMC. The

Table 3: Semi-structured interview for requirement elicitation.

#	Question
1	What is your age?
2	What is or was your occupation?
3	What is your computer experience?
4	What is your computer game experience?
5	What is your analogue game experience?
6	Do you prefer a realistic or a fictional setting?
7	How should cultural rules and morals be treated?
8	Would you prefer time sensitive exercises in the game?

participants were between 57 and 80 years old, and had different backgrounds, e. g. political journalist or car mechanic. The interviews were recorded and transcribed. Per question, the answers were compared to identify common trends. If more than half of the participants supported a trend, it translated in a requirement for the game. If the opinions were divided among multiple trends, the one most often mentioned was chosen as the requirement but the others were also noted in case a later iteration of the design process would discredit this requirement.

With regard to experience with computers, all of the patients indicated that they saw the rise of the computer era in the latter part of their careers and started using them for administrative tasks. All of them still use the computer but mostly to check e-mail or the internet. When asked about their experience with games, both digital and analogue, six patients indicated to still play analogue games and four patients also played digital games. Two reasons for playing games were mentioned. First, they like the social elements involved in the games, enhancing their interaction with friends and family. Secondly, all interviewees mentioned that they like to play games to keep practicing their mind and memory, keeping their brain trained. They also showed a clear dislike for any form of violence in games. Six patients indicated that they prefer a game that is close to reality. Five patients said that they do not like time pressure in a game.

3.3 Resulting Requirements for the Game

Based on the results of the observations, interviews and consults, requirements that the motor dysfunction assessment game should incorporate were identified and listed in Table 4. It can be noticed that two requirements are opposing each other (R3 vs. R10). For the first game concept design we decided to give priority to R10

Table 4: Set of requirements for the game.

Nr.	Requirement
R1	The game needs to incite players to move at the limit of their motion capabilities
R2	The game needs to be supportive of quantitative data retrieval
R3	The game must not be longer than 30 minutes.
R4	The game's duration needs to be easily adjustable
R5	The game needs to incorporate as many functional movements as possible
R6	The game has to have an easy to use, intuitive interface
R7	The game's exercises need to challenge the mind of the player
R8	The game needs to be accessible for a large variety of backgrounds
R9	The game has to have a realistic setting
R10	The game should have no form of time pressure

and ignore R3 and see if this decision negatively affects other requirements.

3.4 Game Concept

Based on the requirements (listed in Table 4, except for R5), a conceptual design of the game was developed. The story of the game, which is named “*post office trouble*”, puts the player in the position of a post office worker who has to sort international packages (R9). The goal of the game is to sort a set of packages while making as few mistakes as possible (R10). Through the HMD, the player sees delivery boxes that are placed in a semi-circle around him (R1). Each box corresponds to a destination which is stated on top of the box. The package that needs to be sorted appears in front of the boxes. Each package shows an image providing a hint on the destination. In Figure 2, destinations are countries and the images show well-known landmarks from these countries.

The player can pick up the package using the thumb and index finger and then move the package into the correct delivery box (R6). Using motion sensors to capture a patient's movements, this process allows for quantitative evaluation of the reach and grasp motion, and assessment of the patient's reachable workspace (R2).

The therapist can change the number of packages that need to be sorted. Thereby, the duration of the game play can be controlled (R3, R4). The therapist can further alter the size of the package as well as its starting location dynamically. Setting up the system in this way allows for patient-tailored evaluation of motor dysfunction. Correspondingly

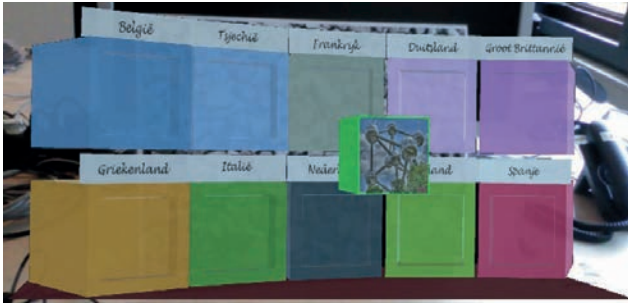

Figure 2: Main game view. The package, bearing a picture of the Atomium of Brussels, has to be placed in the delivery box of ‘Belgium’ (upper left).

to the changing size of the packages, the player has to adjust the gap between his thumb and index finger to grasp the package. The therapist can also change the distance between the delivery boxes and the package, so that the patient’s effective reachable workspace can be determined (R1).

As our main interest lies in the assessment of motor ability, we wish to keep the player moving. To maintain flow in the gameplay, the puzzles should be challenging but not too difficult (R7). Therefore, the player can choose from multiple topics (R8), making the game easier and more engaging at the same time (e. g. landmarks, football clubs, mathematical problems, symbols, cuisine etc.).

4 System Architecture

We designed the system architecture to support functionalities we consider important in our medical application,

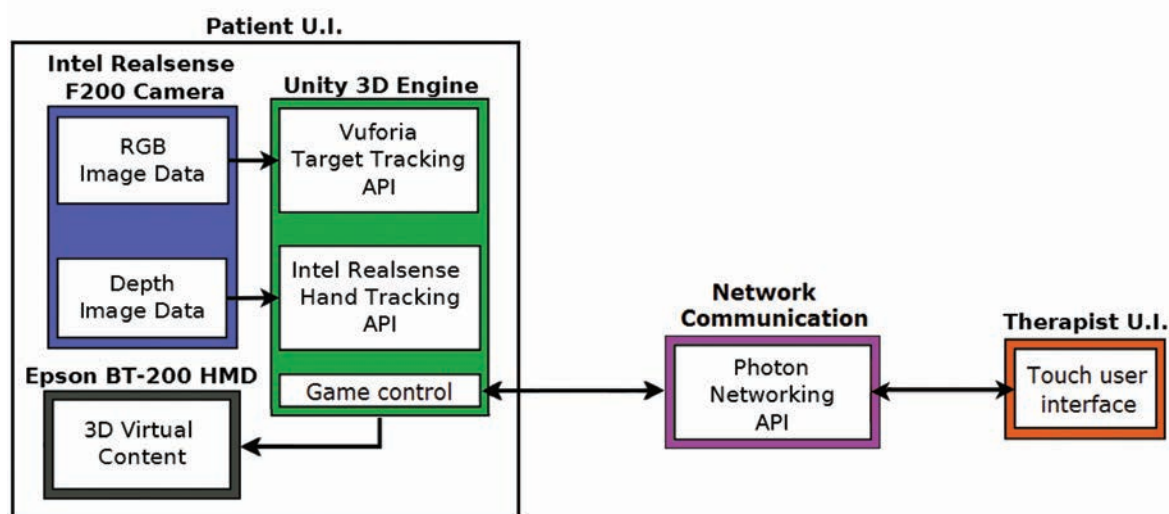

Figure 3: System architecture diagram.

both in the current stage but also for future developments. For patients, these included wearable devices for free hand tracking and visualization that would allow them to move safely and naturally while performing tasks; on the therapist side, it was important to offer tools for adapting the game according to the physical capabilities of each patient. Thus, the architecture of the AR system consists of different interconnected sub-modules (see Figure 3), to support the following three main components:

- Patient user interface: includes fiducial marker detection to anchor the virtual content of the game in the real world; free hand detection to allow natural hand interaction with the AR game environment; game control module; visualization of the AR game using Epson Moverio BT-200 OST-HMD.
- Therapist user interface: Allows therapists to adapt and configure the game for the patient and to see the real-time score of the game.
- Network communication: Enable real time communication between patient user and therapist user.

4.1 Patient User Interface

The users wore the Epson BT-200 OST-HMD with the Intel RealSense F200 mounted on top of it (see Figure 4 (left)). The visualization of the virtual content was done in 2D mode (see Figure 4 (right)). When displayed in an OST-HMD, the black background becomes almost transparent and the virtual objects have a “ghost” like appearance. The virtual content is aligned with the

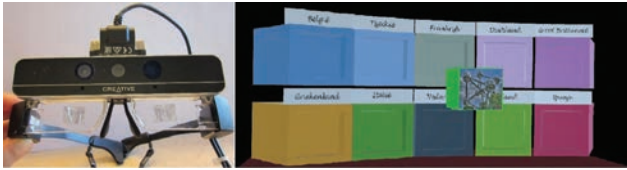

Figure 4: (left) – Intel® RealSense mounted to the Epson BT-200; (right) – the virtual content displayed in the HMD.

real world. Simulated views of the user can be seen in Figure 7–Figure 9.

The Intel RealSense Hand Tracking API (<https://software.intel.com/en-us/intel-realsense-sdk/download>) was used to locate and track the hand as well as fingers. For spatial and temporal alignment of the real world and the virtual world, we used the feature detection marker system Vuforia (<https://developer.vuforia.com/>). The video being captured by the RGB camera was sent to the Vuforia Target Tracking API (see Figure 3), which detected the fiducial marker placed in front of the user (see Figure 5). Then, all the virtual content of the game was placed in a specific position relative to this marker. Thus, the destination boxes were placed on a virtual plane, perpendicular to the marker, 3 cm in front. Each package is a cube with the edge length of 5 cm, generated at a distance between 15–20 cm from the destination boxes. These measurements are all approximate distances, suitable for reach-and-grasp based tasks. We used a large marker (i. e., A3 size) to ensure that tracking of the marker would not be lost when the hand was placed between the camera and the marker.

The application started with a calibration phase, during which the user had to show the hand in front of the RGB-D camera, making various slight movements. During this process, the system learned the features of the hand, to provide robust recognition and tracking for each user. A suggestive icon was displayed in the upper right corner of the HMD, to alert the user when the hand was not being tracked during the game (e. g. because it

was not in view of the camera). The user was instructed to keep the hand with the palm oriented towards the Intel RealSense sensor to avoid fingers being occluded from the sensor. Although this led to an unnatural way of grasping objects, we imposed this restriction to ensure a more robust hand tracking and a better usability of the system.

Once the calibration was completed, the user could start playing the game. When the user grasped a package, its colour turned cyan and it could be rotated around the vertical axis and translated in all directions, following the movements of the hand. If hand tracking was lost or the patient released the package, it became green again. The package disappeared as soon as it touched a trigger zone (defined inside of each delivery box). The score was updated and sent to the local therapist. After 3 seconds, a new package was displayed. The user had to repeat the task until all packages were sorted.

If the user looked away from the fiducial marker, a full screen view of the image on the package was shown. The game view was properly displayed again when the user looked at the marker again.

4.2 Local Therapist User Interface

We designed a user interface in Unity3D (see Figure 6) that allows a local therapist to control different parameters of the game. The local therapist can change the size of the packages, can choose the theme of the pictures displayed on the packages and set the number of packages that the patient is supposed to sort in one game session. The therapist can further see on the screen the real-time score of the patient in the game, i. e. the number of packages placed in the right box and the ones in the wrong box. The application for the local therapist runs on a smart phone, but it can be used also on a tablet or a laptop.

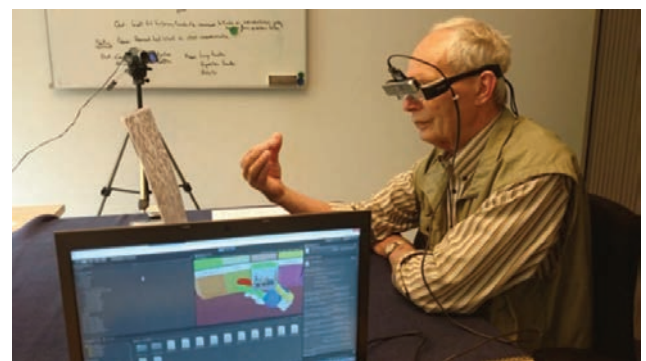

Figure 5: (left) – the setup; (right) – one of the participants during the experiment.

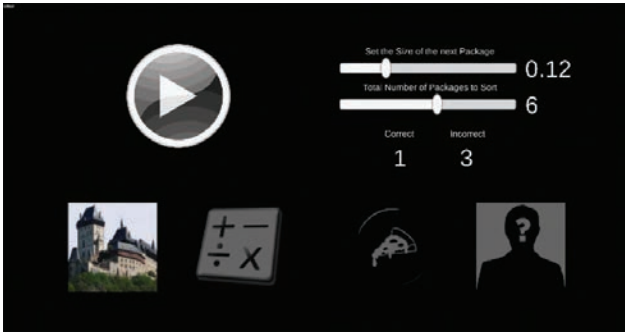

Figure 6: An example interface for the local therapist.

4.3 Photon Server

All components of the system are connected through a local Photon Server, which has originally been developed as a cross platform multiplayer game networking framework (<https://www.exitgames.com/en/OnPremise>). The application allows many users (players) to join together in a shared game session; transfer data and messages synchronously, in real-time, between connected players, across platforms. In our system, the Photon server will be used for communication between the local therapist application and the patient application in both directions, through sending/receiving synchronous messages and with the remote procedure call (RPC) mechanism.

5 User Studies

The goal of the user studies is to evaluate the engagement of players in the “*post office trouble*” game. According to Ijsselsteijn et al. [19] a good game design should always take two factors into account: usability and user experience. We first conducted a short usability study on different ways to provide visual feedback for the hand in AR. Based on the findings, one visual hand feedback condition was chosen for a second user study on engagement. In both studies, participants were able to perform the tasks in AR without wearing their correction glasses.

5.1 Usability Study on Visual Hand Feedback in AR

In our first user study we tested three different modalities for presenting the user’s hand virtually to facilitate interaction with virtual objects and grasping them in a natural

way [10]. We explored the effect of the following three modalities:

- No virtual augmentation of the hand (see Figure 7);
- A partial augmentation of the hand, showing the tips of the index finger and thumb (see Figure 8);
- Full virtual augmentation of the hand (see Figure 9).

The first modality was assumed to provide the most natural interaction experience, because it would enable a realistic and seamless interaction with the virtual objects (i. e., without any visual interference/aid). Therefore, this modality was chosen as the baseline for comparison. The partial augmentation was comprised of the index finger and thumb, which have an important function in grasping objects. The user may benefit from this limited information on the hand tracking, without being overloaded with visual information. The last modality shows the user a full model of the tracked hand, which may provide more feedback for interacting with the virtual content.

Five participants, aged 57, 58, 59, 63, 63 and working in academic environments, were asked to sort 3 boxes under each condition.

After the experiment, the participants filled out the System Usability Scale (SUS) [8], allowing for easy quantification and interpretation of the users’ responses (the scores are compared to the threshold value 68: good usability for higher scores; low usability for lower scores). The results are summarized in Table 5.

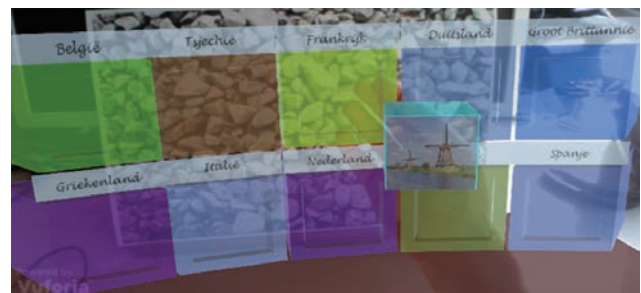

Figure 7: Simulated HMD view for no augmented hand.

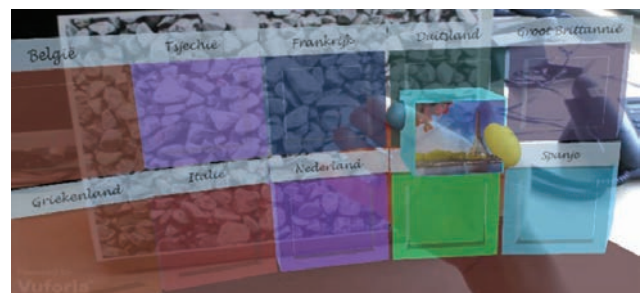

Figure 8: Simulated HMD view for partial augmented hand.

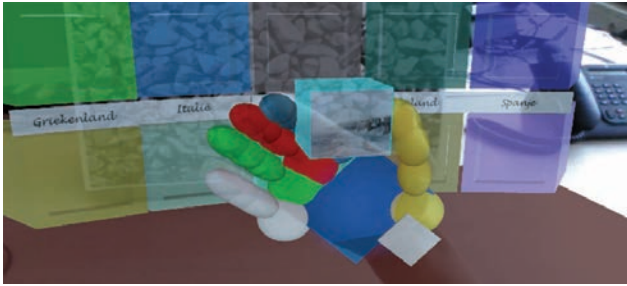

Figure 9: Simulated HMD view for full augmented hand.

Although four out of five participants gave low SUS scores for all three conditions, all participants indicated that the visual hand model conditions provided better usability than having no hand model at all. A more comfortable and ergonomic HMD would also provide a better user experience, as some of the participants complained about the pressure felt on nose and ears due to the weight of the current device.

5.2 Study on Engagement

Eight participants (4 male, 4 female), aged between 52 and 79 (five of these participants were below 65) with various professional backgrounds, participated in a study on engagement [12]. None of the participants had used an AR system before and only half of them indicated to play digital games (only short mobile games). They were asked to sort 10 boxes under the “full augmented hand” condition.

5.2.1 Questionnaires

To measure the engagement of the participants, we used the Game Experience Questionnaire (GEQ) [18]. For the

GEQ, seven different dimensions of experience were identified as elements that match with being engaged. Thus, *competence* shows how competent a person feels in the game. *Sensory and imaginative immersion* is about how the person perceived the game world and how much he felt that he was in it. *Flow* stands for “the state in which people are so involved in an activity that nothing else seems to matter; the experience itself is so enjoyable that people will do it even at great cost, for the sheer sake of doing it” [11]. *Challenge* shows how much the player felt positively challenged to complete the game. *Positive affect* is about how much positive emotions the game aroused in the player whereas *negative affect* is the amount of negative emotions aroused by the game. *Tension and annoyance* is the amount of irritation the player felt during play, which is closely related to negative affect but the difference is in tension being actively aimed at the game and negative affect being a passive feeling, like boredom. The scores of the seven aspects were compared between players to understand the average engagement the players felt. For a positive score, the first five aspects should have a high ranking and the latter two should have a low ranking.

The GEQ [18] exists out of multiple modules, namely a core module, a short in-game module, a social presence module and a post-game module. As the focus of this research is to study the engagement of the player during gameplay, only the 33 questions of the core module were used. The in-game module was not used because it is most useful when comparing different gameplays or modes, requiring short questionnaires in between the parts, and this was not the case. The core-module questions together with the associated dimension of player experience are shown in Table 6. Each question is a statement and the participant answers how much this statement was the case on a 5 point Likert scale from “not at all” to “very”.

Table 5: Results from the user study – columns 3–5 show the SUS scores under each condition.

Participant	AR Experience	No augmentation of the hand (see Figure 7)	Partial augmentation of the hand (see Figure 8)	Full augmentation of the hand (see Figure 9)	Observations
1 (male)	little	27.5	40	42.5	Difficulties with the temporal loss of hand tracking
2 (female)	no	82.5	85	75	Very good at keeping her hand in the optimal pose and position for tracking
3 (male)	no	30	60	50	Difficulties with hand tracking
4 (male)	no	30	55	60	Problems with the hand calibration and the subsequent hand tracking
5 (male)	no	25	17.5	27.5	Hand tracking was quite robust but he reported choppy frame rate

Table 6: GEQ questions (QG#) together with the associated dimension of player experience [18]: Competence (CO), sensory and imaginative Immersion (I), Flow (F), Challenge (CH), Positive Affect (PA), Negative Affect (NA), and Tension and Annoyance (TA).

#	Question	Associated dimension	#	Question	Associated dimension
1	I felt content	PA	18	I felt imaginative	I
2	I felt skilful	CO	19	I felt that I could explore things	I
3	I was interested in the game’s story	I	20	I enjoyed it	PA
4	I thought it was fun	PA	21	I was fast at reaching the game’s targets	CO
5	I was fully occupied with the game	F	22	I felt annoyed	TA
6	I felt happy	PA	23	I felt pressured	CH
7	It gave me a bad mood	NA	24	I felt irritable	TA
8	I thought about other things	NA	25	I lost track of time	F
9	I found it tiresome	NA	26	I felt challenged	CH
10	I felt competent	CO	27	I found it impressive	I
11	I thought it was hard	CH	28	I was deeply concentrated in the game	F
12	It was aesthetically pleasing	I	29	I felt frustrated	TA
13	I forgot everything around me	F	30	It felt like a rich experience	I
14	I felt good	PA	31	I lost connection with the outside world	F
15	I was good at it	CO	32	I felt time pressure	CH
16	I felt bored	NA	33	I had to put a lot of effort into it	CH
17	I felt successful	CO			

As Ijsselsteijn et al. [19] mentioned, usability is an important component that needs to be taken into account when evaluating engagement of a game. Therefore, beside the GEQ we also asked the participants to complete the SUS questionnaire [8]. In addition to the questionnaires, two qualitative methods were also applied to gather feedback from the participants. First, the test sessions were recorded to capture actions taken and the expressions made by the participants. Secondly, the participants were also debriefed to discuss problems they experienced during the test session.

5.2.2 Usability

The resulting SUS scores (with $M = 60$ and $Std = 21$) were wide spread and indicated that usability needs to be improved. Figure 10 shows that there seems to be a positive link between SUS and computer experience (i. e., higher usability scores in participants with more PC experience), which suggests that the wide spread of SUS scores might (partly) be explained by the PC experience varying between “a little” and “a lot”. Alternatively, the large variation in SUS scores may be explained by the fact that none of the participants had ever played with an AR application before. This would mean that they did not have any comparative material and their usability scores are thus based on the expectations the participants had. As AR technology was a novelty to them, these expectations will have been different for each participant and their answers will

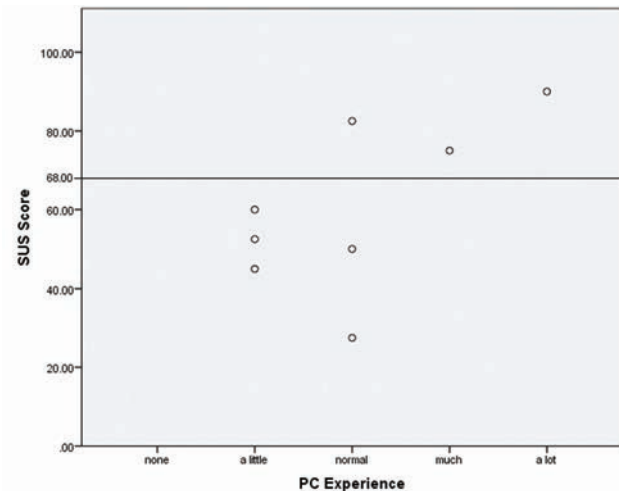

Figure 10: SUS results versus PC experience. The threshold for ‘good usability’ was set at a SUS score of 68.

thus be more spread than if they would rate a normal computer application. Although this might explain the spread, it does not diminish the fact that the usability is still low and needs further improvement.

5.2.3 Game Experience

Boxplots for the seven GEQ categories are displayed in Figure 11. The first five categories require a high score but on average, all scored between 2 and 3. Competence and immersion do have a larger deviation but the majority of scores was

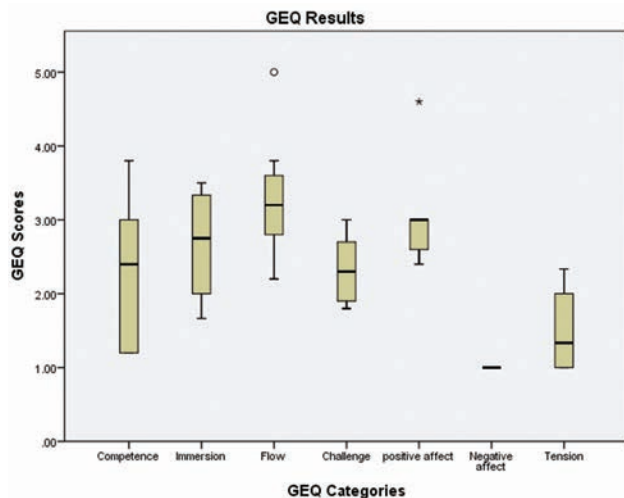

Figure 11: GEQ Results (N = 8).

below 3. The challenge factor was rated by all participants to be below 3 and positive affect was mostly rated on three with a few below. Flow had a better result as it was rated between 2 and 4 with an average slightly above 3. The two categories requiring low ratings did have low results, with all participants saying they did not feel negative affect. Tension was rated a bit higher (between 1 and 2) but the majority off the participants rated tension with a 1 as well.

The GEQ results show that the participants felt the positive aspects somewhere between “slightly” to “moderately”, indicating that they were not that engaged by the game. At the same time, they did not feel negative affect nor was there any tension created by the game. If the game had been simply bad, higher scores on these negative aspects would have been expected. It is thus difficult to understand the performance of the game. Three possible scenarios could explain the results gathered from the experiment.

First, there is the possibility that the GEQ results are not influenced by any other factors. The game is simply interesting enough not to get bored or annoyed but is not that engaging either. This would mean that the focus of further research should be on improving the engagement of the game.

The second option is that the game is not engaging at all and the current scores are a result of the participants’ interest in the novelty of the AR technology. Alternatively, participants may have been too polite to express the real negative affect and tension they might have felt during playing the game. In this case the best course of action would be to design a new game that is more engaging.

The last option is that the game is engaging, but that the lower usability is suppressing the positive aspects of the experience for the participants. The game would then have potential for engagement but further research should focus

on upgrading the usability of the game. Unfortunately, with the current sample size and experiment results, it is impossible to say which of the options is most likely.

5.2.4 Observations

The patients were observed to see how they reacted to their progress in the game and if there were any specific problems they encountered. In general, each participant showed willingness to play the game and, after some irritation caused by the novel technology, participants started getting used to the system. It was also observed that multiple participants fixed the HMD with their left hand. Two participants appeared to have difficulties with the puzzles, expressing that it was a subject they knew not much about. Two others found the puzzles easy and were finished quite quickly.

Three of the participants had troubles with perceiving the depth in the virtual environment, often grabbing in front or behind the package or stopping in front of the sorting boxes, thinking they were already there. In general, participants also had trouble getting their hand recognised. During the session they had to get used to which positions were recognised and which were not until in the end of the session things worked better. One person managed to move all packages with the back of the hand towards the sensor, where for everybody else this would have resulted in loss of tracking. Some participants had trouble coordinating the hand with the head. As the sensors are placed on the HMD, the player has to keep the hand in his sight so as not to lose the package. In real life though, people tend to look to the goal of the objective so when the package has been picked up people often focus on the correct box, losing the package out of sensor sight. The participants got used to it with some practice except for three of them, who had trouble adapting and often lost the package and hand out of sight.

Two of the participants also had some initial trouble with enlarging the image by looking to the side. Their intuitive reaction was to bring the package closer which often resulted in obscuring the marker from the camera, thus losing the virtual environment. One of them got used to looking to the side and the other did not. Three participants who wore correction glasses tried to wear the HMD over them but this did not work and the participants choose to take off their own glasses.

5.2.5 Debriefing

The de-briefing of the game was used to gather more qualitative data on the experience of the game, difficulties

the players had, and opportunities to improve the game design. Several issues that were raised by multiple people are shown in Table 7, ordered by the amount of people expressing that issue. The first issue raised is that the sensors work best as long as they see the palm of your hand. Four participants expressed that they found this movement very difficult and unnatural, especially when putting the package away in the boxes. Another raised issue by three of the participants was that the texts and images were not recognizable enough. For the text on top of the destination boxes, this means that it was not big enough and the font was also not recognisable enough. The approach of viewing the image on the package in large by looking away from the fiducial marker was not working for the participants. One participant stated that this felt like stepping out of the game and then stepping back in again, so he avoided using this solution. Three of the participants also found the AR glasses cumbersome as they were heavy and had a tendency to slip on the nose which then misaligned the display with the eyes. Also mentioned by three of the participants was the need for more practice before playing the game. The main reason for this was to get more time to get used to the technology. Four participants felt that the game was confined to a small space because the boxes were displayed in a square in front of them resembling a screen. This limitation caused participants to keep their head focussed on the middle, sometimes even dropping the hand out of sensor range when trying to reach a box. It should be noted that three of the participants also clearly stated that they found the game a fun experience.

Table 7: List of issues reported by participants.

	Issue	# of people (out of 8 participants)
1	Unnatural movement and grip	4
2	Feeling confined to a screen	4
3	Image and text not visible enough	3
4	Heavy AR HMD	3
5	More practice would be helpful	3
6	Difficult to perceive depth	3
7	Difficult head-hand coordination	3
8	Not glasses friendly	3

6 Conclusion

This paper described an AR system and a game designed for assessment of upper extremity motor dysfunction in various patient groups. Results from two user studies are reported.

The first user study suggested that a virtual augmentation of the hand may allow for better interaction with virtual objects compared to no virtual augmentation of the hand. But to maximize comparability to situations and behaviour in daily life, we will work on improving the user experience in conditions without virtual representation of the virtual hand, by means of establishing a good spatial alignment of the virtual and the real world in 3D stereo visualisation. Generally, the system appeared difficult to use. However, it would be suitable for evaluation of reaching and grasping, with the condition of having more robust hand tracking and a faster and less choppy framerate.

The results of the second user study show that the usability of the game is still quite low (five of the participants gave scores below the average SUS value of 68). This happened mainly because the movements are slightly unnatural, due to the restrictions of our current set-up, as the optimal pose for hand tracking is with the palm facing the sensor. This could have a major impact on engagement and should be solved before more accurate measurements can be taken. Even so, the GEQ answers indicate that all participants experienced a relatively good flow, did not feel negatively affected by the limitations of the system and could fully concentrate on the game. These led us to the conclusion that there might be potential for engagement, which could emerge with improved usability.

For the next steps in development of our AR system, we will focus on improving the usability which is essential for testing our system with patients. For that purpose, we consider using motion sensor based approaches for hand tracking to provide more fluid interaction using natural poses of the hands with the virtual content. In addition, we will improve the stereo 3D visualization of the virtual content in the OST-HMD for a better depth perception of the users. Also, we currently work on the design and implementation of a tangible interaction game involving a smart product (i. e., a real object containing different sensors for getting its position and orientation), which could provide a better alignment of the virtual world with the real world as well as additional data on the motion behaviour.

Moreover, we intend to make a step towards the validation of the prototype. To this end, studies with patients will be conducted to further explore the usability and engagement of the system, and to compare various parameters of hand and arm function obtained from the sensors during game play to the outcomes of current procedures for assessing upper extremity motor dysfunctions.

Acknowledgements: This work is part of the research programme Technology in Motion (TIM [628.004.001]), which is financed by the Netherlands Organisation for Scientific Research (NWO).

References

- [1] Abdo, W. F., B. P. C. van de Warrenburg, D. J. Burn, N. P. Quinn and B. R. Bloem. 2010. "The Clinical Approach to Movement Disorders." *Nature Reviews Neurology* 6 (1). Nature Publishing Group, pp. 29–37.
- [2] Alamri, A., J. Cha and A. El-Saddik. 2010. AR-REHAB: An Augmented Reality Framework for Poststroke-Patient Rehabilitation. *Instrumentation and Measurement, IEEE Transactions on*, 59(10), pp.2554–2563.
- [3] Azuma, R., Y. Bailiot, R. Behringer, S. Feiner, S. Julier and B. MacIntyre. 2001. "Recent advances in augmented reality," *Comput. Graph. Appl. IEEE*, vol. 21, no. 6, pp. 34–47.
- [4] Barros, H. O., M. M. Soares, E. L. R. Filho, W. Correia and F. Campos. 2013. Virtual Reality Immersion: An Important Tool for Diagnostic Analysis and Rehabilitation of People with Disabilities. In A. Marcus (Ed.), *Design, User Experience, and Usability. User Experience in Novel Technological Environments* (Vol. 8014), pp. 337–344. Springer Berlin Heidelberg.
- [5] Benyon, D., P. Turner and S. Turner. 2005. Designing interactive systems, Addison-Wesley.
- [6] Botella, C. M., M. C. Juan, R. M. Baños, M. Alcañiz, V. Guillén and B. Rey. 2005. Mixing Realities? An Application of Augmented Reality for the Treatment of Cockroach Phobia. *Cyberpsychology & behavior*, 8(2), pp.162–171.
- [7] Broeren, J., A. Björkdahl, R. Pascher and M. Rydmark. 2002. Virtual reality and haptics as an assessment device in the postacute phase after stroke. *Cyberpsychology & behavior: the impact of the Internet, multimedia and virtual reality on behavior and society*, 5(3), pp.207–211.
- [8] Brooke, J. 1996. SUS: A „quick and dirty“ usability scale. *Usability Evaluation in Industry*, Taylor and Francis, 1996.
- [9] Burke, J. W., M. D. J. McNeill, D. K. Charles, P. J. Morrow, J. H. Crosbie and S. M. McDonough. 2009. Optimising engagement for stroke rehabilitation using serious games. *The Visual Computer*, 25(12), pp.1085–1099.
- [10] Cidota, M. A., R. M. Clifford, P. Dezentje, S. G. Lukosch and P. J. M. Bank. 2015. Affording Visual Feedback for Natural Hand Interaction in AR to Assess Upper Extremity Motor Dysfunction. *IEEE International Symposium on Mixed and Augmented Reality*, pp. 92–95.
- [11] Csikszentmihalyi, M. 1992. *Flow: The Psychology of Happiness*. London: Random House.
- [12] Dezentje, P., M. A. Cidota, R. M. Clifford, S. G. Lukosch, P. J. M. Bank and H. K. Lukosch. 2015. Designing for Engagement in Augmented Reality Games to Assess Upper Extremity Motor Dysfunctions. *IEEE International Symposium on Mixed and Augmented Reality – Media, Art, Social Science, Humanities and Design*, pp. 57–58.
- [13] Dickey, M. D. 2005. Engaging by design: How engagement strategies in popular computer and video games can inform instructional design. *Educational Tech. Research and Development*, 53(2), pp.67–83.
- [14] Garris, R., R. Ahlers and J. E. Driskell. 2002. Games, Motivation, and Learning: A Research and Practice Model. *Simulation & Gaming*, 33(4), pp. 441–467.
- [15] Ha, T., S. Feiner and W. Woontack. 2014. WeARHand: Head-worn, RGB-D camera-based, bare-hand user interface with visually enhanced depth perception. *IEEE International Symposium on Mixed and Augmented Reality*, pp. 219–228.
- [16] Hondori, H. M., M. Khademi, L. Dodakian, S. C. Cramer and C. V. Lopes. 2013. A Spatial Augmented Reality Rehab System for Post-Stroke Hand Rehabilitation. In *Medicine Meets Virtual Reality*, vol. 184, pp. 279–285.
- [17] Huizinga, J. 1949. *Homo Ludens. A Study of the Play-Element in Culture*. Milton Park: Routledge.
- [18] Ijsselsteijn, W., W. Van Den Hoogen, C. Klimmt, Y. De Kort, C. Lindley, K. Mathiak, K. Poels, N. Ravaja, M. Turpeinen and P. Vorderer. 2008. Measuring the Experience of Digital Game Enjoyment. In *Proceedings of Measuring Behavior*, pp. 7–8.
- [19] Ijsselsteijn, W., H. Herman Nap, Y. de Kort and K. Poels. 2007. Digital Game Design for Elderly Users. In *Proceedings of the 2007 Conference on Future Play – Future Play '07*, 17. New York, USA: ACM Press.
- [20] Juul, J. 2008. The Magic Circle and the Puzzle Piece. *Conference Proceedings of the Philosophy of Computer Games 2008*, ed. by Stephan Günzel, Michael Liebe and Dieter Mersch, Potsdam: University Press, pp. 056–067.
- [21] Khademi, M., H. M. Hondori, C. V. Lopes, L. Dodakian and S. C. Cramer. 2012. Haptic Augmented Reality to monitor human arm's stiffness in rehabilitation. In *IEEE EMBS Conference on Biomedical Engineering and Sciences*, pp. 892–895.
- [22] Klabbers, J. 2006. *The Magic Circle*. Amsterdam: Sense Publishers.
- [23] Leach, M. J., S. L. Gall, H. M. Dewey, R. A. L. Macdonell and A. G. Thrift. 2011. Factors associated with quality of life in 7-year survivors of stroke. *Journal of Neurology, Neurosurgery and Psychiatry*, vol. 82, pp. 1365–1371.
- [24] Meijer, S. 2009. The organisation of transactions. Studying supply networks using gaming simulation. Wageningen University.
- [25] Muslimovic, D., B. Post, J. D. Speelman, B. Schmand and R. J. de Haanm. 2008. Determinants of disability and quality of life in mild to moderate Parkinson disease. *Neurology*, 70, pp. 2241–2247.
- [26] Rizzo, A. and G. J. Kim. 2005. A SWOT analysis of the field of virtual reality rehabilitation and therapy. *Presence* 14, pp. 119–146.
- [27] Rollings, A. and E. Adams. 2003. *Game Design* (1st edition). New Riders Publishing.
- [28] Salen, K. and E. Zimmermann. 2003. *Rules of Play: Game Design Fundamentals*. MIT Press, Cambridge.
- [29] Smeddinck, J. D., M. Herrlick and T. Malaka. 2015. Exergames for Physiotherapy and Rehabilitation: A Medium-term Situated Study of Motivational Aspects and Impact on Functional Reach. In *CHI '15*. pp. 4143–4146.
- [30] Taske, A., L. Oppermann, K. Niemann and R. Wilken. 2015. Design and Evaluation of a Stroke Rehabilitation Program Virtuelle und Erweiterte Realität - 12. Workshop der GI-Fachgruppe VR / AR, Shaker Verlag, pp. 34–45.
- [31] Whitton, N. 2010. Game Engagement Theory and Adult Learning. *Simulation & Gaming*, pp. 1–14.
- [32] Zhou, F., H. Been-Lirn Duh and M. Billinghurst. 2008. Trends in augmented reality tracking, interaction and display: A review of ten years of ISMAR. In *Proceedings of the 7th IEEE / ACM ISMAR*, 08. IEEE Computer Society, Washington, DC, USA, pp. 193–202.

Bionotes



Marina A. Cidota
Delft University of Technology,
Delft, The Netherlands
m.a.cidota@tudelft.nl

Marina Cidota obtained her PhD in 2008 at University of Bucharest, where she taught different seminars and courses at the Faculty of Mathematics and Computer Science. Since 2014 she has been Postdoc researcher at TU Delft, Faculty of Technology, Policy and Management. Her research focuses now on designing for engagement and awareness in a collaborative system. In her current work, Augmented Reality technologies, Serious Gaming and marker-less tracking of human body are combined to develop unobtrusive, cost-effective and patient-friendly tools for objective assessment of upper extremity motor dysfunction.



Stephan G. Lukosch
Delft University of Technology,
Delft, The Netherlands
s.g.lukosch@tudelft.nl

Stephan Lukosch is associate professor at the Delft University of Technology. His current research focuses on creating engaging environments in mixed reality. Using augmented reality, he researches environments for virtual co-location in which individuals can virtually be at any place in the world. Using serious games, he researches on how to create effective training or assessment environments. In his research, he combines his recent results from intelligent and context-adaptive collaboration support, collaborative storytelling for knowledge elicitation and decision-making, and design patterns for computer-mediated interaction.



Paul Dezentje
Delft University of Technology,
Delft, The Netherlands
pauldezentje80@gmail.com

Paul Dezentje obtained his B.Sc. in Molecular Science and Technology and his M.Sc. in Engineering and Policy Analysis at the Delft University of Technology.



Paulina J.M. Bank
Leiden University Medical Center,
Leiden, The Netherlands
p.j.m.bank@lumc.nl

Paulina J.M. Bank is a human movement scientist who has been working at the LUMC Department of Neurology since 2009 and obtained her PhD in 2014. Her research is focused on the assessment of arm and hand motor function in patients with neurological disorders such as stroke, Parkinson's Disease, and Complex Regional Pain Syndrome. She strives to build a bridge between clinicians and engineers to develop low-cost setups for unobtrusive and objective quantification of motor (dys) function and its underlying determinants, exploiting systematic manipulations of task and environmental factors to test the patients' adaptive capacities.



Heide K. Lukosch
Delft University of Technology,
Delft, The Netherlands
h.k.lukosch@tudelft.nl

Heide Lukosch is an assistant professor with a background in social and media sciences. Heide explores the design and effects of interactive visualization techniques like simulation games. Amongst others, she has co-developed virtual environments for team training of police teams, and games for further technical education. Heide's research aims at supporting actors in complex situations to develop situational awareness in order to increase their performance.



Rory M.S. Clifford
Human Interface Technology Laboratory,
University of Canterbury, Christchurch,
New Zealand
rory.clifford@pg.canterbury.ac.nz

Rory Clifford is PhD Student and Researcher in User Experience for Virtual Reality and Augmented Reality Experiences. Focusing on serious applications for training and learning purposes in medical as well as for training in hazardous occupations.