

High-accuracy absolute distance measurement with a mode-resolved optical frequency comb

Voigt, Dirk; Van Den Berg, Steven A.; Lešundák, Adam; van Eldik, S.; Bhattacharya, Nandini

DOI

[10.1117/12.2227360](https://doi.org/10.1117/12.2227360)

Publication date

2016

Document Version

Final published version

Published in

Optical Sensing and Detection IV

Citation (APA)

Voigt, D., Van Den Berg, S. A., Lešundák, A., van Eldik, S., & Bhattacharya, N. (2016). High-accuracy absolute distance measurement with a mode-resolved optical frequency comb. In F. Berghmans, & A. G. Mignani (Eds.), *Optical Sensing and Detection IV* (Vol. 9899, pp. 1-10). [989906] (Proceedings of SPIE; Vol. 9899). SPIE. <https://doi.org/10.1117/12.2227360>

Important note

To cite this publication, please use the final published version (if applicable).
Please check the document version above.

Copyright

Other than for strictly personal use, it is not permitted to download, forward or distribute the text or part of it, without the consent of the author(s) and/or copyright holder(s), unless the work is under an open content license such as Creative Commons.

Takedown policy

Please contact us and provide details if you believe this document breaches copyrights.
We will remove access to the work immediately and investigate your claim.

High-accuracy absolute distance measurement with a mode-resolved optical frequency comb

Dirk Voigt^{*a}, Steven A. van den Berg^a, Adam Lešundák^b, Sjoerd van Eldik^{c,d}, Nandini Bhattacharya^c
^aVSL Dutch Metrology Institute, Thijsseweg 11, 2629 JA Delft, The Netherlands; ^bInstitute of Scientific Instruments AS CR v.v.i, Královopolská 147, Brno, Czech Republic; ^cDelft University of Technology, Lorentzweg 1, 2628 CJ Delft, The Netherlands; ^dnow at MAPPER Lithography, Computerlaan 15, 2628 XK Delft, The Netherlands

ABSTRACT

Optical interferometry enables highly accurate non-contact displacement measurement. The optical phase ambiguity needs to be resolved for absolute distance ranging. In controlled laboratory conditions and for short distances it is possible to track a non-interrupted displacement from a reference position to a remote target. With large distances covered in field applications this may not be feasible, e.g. in structure monitoring, large scale industrial manufacturing or aerospace navigation and attitude control. We use an optical frequency comb source to explore absolute distance measurement by means of a combined spectral and multi-wavelength homodyne interferometry. This relaxes the absolute distance ambiguity to a few tens of centimeters, covered by simpler electronic distance meters, while maintaining highly accurate optical phase measuring capability. A virtually imaged phased array spectrometer records a spatially dispersed interferogram in a single exposure and allows for resolving the modes of our near infrared comb source with 1 GHz mode separation. This enables measurements with direct traceability of the atomic clock referenced comb source. We observed agreement within 500 nm in comparison with a commercial displacement interferometer for target distances up to 50 m. Furthermore, we report on current work toward applicability in less controlled conditions. A filter cavity decimates the comb source to an increased mode separation larger than 20 GHz. A simple grating spectrometer then allows to record mode-resolved interferograms.

Keywords: distance measurement, spectral interferometry, optical frequency comb, frequency mode filter, laser ranging, optical metrology, traceability, measurement uncertainty

1. INTRODUCTION

The development of optical frequency comb sources¹ allows for long-distance interferometric absolute ranging^{2,3}. A frequency comb source provides a broad spectral range of thousands of accurately known optical frequencies that can be utilized for measurements with direct traceability to an atomic clock time standard. The comb can, for instance, be established by means of a mode-locked femtosecond pulsed Ti:Sapphire laser. The pulse repetition rate in the time domain, f_{rep} , corresponds to the mode spacing in the frequency domain, mathematically described by a Fourier transform. A single frequency mode of the comb can be formalized as $f_p = f_0 + p f_{\text{rep}}$, with p a large (10^5 to 10^6) integer number and f_0 an overall offset frequency. In our instrumentation, both f_{rep} and f_0 are stabilized to an atomic clock to 10^{-11} fractional uncertainty in 1 s averaging time. Any single frequency mode is then stabilized and known to this accuracy level.

The broad optical comb spectrum can be exploited in terms of combined spectral (“white light”) and multi-wavelength homodyne interferometry, relaxing the absolute distance ambiguity to a few tens of centimeters, which is within the accuracy of lower cost distance meters, while maintaining highly accurate interferometric optical phase measuring capability. We report on recent work on this hybrid interferometry approach^{4,5}.

The basic measurement configuration is a Michelson interferometer with a stationary local reference mirror and a target positioned at a variable remote distance (cf. Figure 3). Our Ti:Sapphire laser source has a mode spacing of 1 GHz. These modes are individually resolved by means of a virtually imaged phased array (VIPA)^{4,6,7}. Mode-resolved comb interferometry was demonstrated for distances up to 50 m with sub-micrometer accuracy in stable ambient laboratory conditions⁵.

*dvoigt@vsl.nl; phone 31 15 269 1500; fax 31 15 269 271; vsl.nl

Likewise applications in analytical spectroscopy and astronomy^{6,7,8,9,10} this allows for detection in a single image exposure, without mechanically scanning components in the measurement set-up, yet providing interferometric resolution and accuracy at the scale of the optical wavelength. The spatial dispersion of the frequency resolved signal on an imaging sensor reduces detection system complexity as compared with radio frequency electronic detections schemes such as, e.g., double comb heterodyne spectroscopy^{11,12}, though at cost of limited sampling rate from image readout.

In this report we discuss the methodological approach and basic experimental results of the mode-resolved frequency comb interferometry. Furthermore, we address current work on instrumental aspects for high accuracy ranging application under less controlled, e.g. outdoor conditions. In order to reduce system complexity involved with highest level spectral resolution of the VIPA approach, we implemented an optical filter cavity that decimates the transmitted comb modes^{9,10,13,14,15}. The filtered comb spectrum has a mode spacing of a multiple of the inserted 1 GHz pulse repetition rate. Aiming for a filtered mode spacing between 20 GHz and 100 GHz allows us to resolve the modes with a simple grating spectrometer. The filter cavity is also considered to enable VIPA based mode-resolution for frequency combs, e.g. fiber laser source, with considerably higher repetition rate and otherwise too small mode spacing.

2. FREQUENCY COMB DISTANCE MEASUREMENT INTERFEROMETRY

2.1 Spectral interferometry

The basic interferometry configuration is a Michelson interferometer with a static reference retro-reflector and a displacing target reflector (cf. Figure 3 and Van den Berg *et al.*⁵ for a more detailed instrumental description). Our source is a femtosecond Ti:Sapphire frequency comb with $f_{\text{rep}} = 1$ GHz pulse repetition rate and a spectral envelope of 810 nm to 830 nm wavelength. The VIPA spectrometer is used to resolve all individual comb frequencies as being spatially dispersed on a camera imaging CCD sensor. The VIPA etalon has a nominal free spectral range (FSR) of 50 GHz and provides angular spectral dispersion with high resolution in the vertical imaging plane. A grating provides additional angular dispersion in the horizontal plane, thus removing the FSR ambiguity of the VIPA-resolved comb modes that appear as a dot array pattern in the images, with 1 GHz vertical separation of adjacent frequency modes. Concatenating the horizontally grating-dispersed dot columns provides an unwrapped spectral interference fringe, composed of the multitude of comb mode peaks (pixel graylevel counts). Figure 1 illustrates this for an interferogram with the target reflector placed at $L_{\text{tot}} \approx 20$ m total measuring distance. In this interference fringe, each comb mode represents a measured intensity $I(\lambda_p)$ for the respective wavelength λ_p ,

$$I(\lambda) = I_0 \cos\left(2\pi \frac{2nL}{\lambda}\right) = I_0 \cos(\Phi), \quad (1)$$

with path length difference L between the respective interfering pulses from target and reference beam, air refractive index n and the fringe spectral phase rewritten as a function of the optical frequency, $\Phi(f) = 4\pi nL f/c$. The frequency derivative of this measured spectral phase directly solves to the length L ,

$$\frac{d\Phi}{df} = \frac{4\pi n_g L}{c} \Leftrightarrow L = \frac{d\Phi}{df} \frac{c}{4\pi n_g}, \quad (2)$$

with air group refractive index $n_g = n + f \, dn/df$. Note, that for this determination of L no high accuracy *absolute* frequency calibration of the VIPA spectrometer is required. Merely the *relative* dispersive scale has to be determined.

However, with further displacing target, the interferogram is periodically repeating according to the pulse-to-pulse separation $L_{\text{pp}} = c/(n_g f_{\text{rep}})$ of the comb optical pulse train, causing ambiguity of the queried total distance,

$$L_{\text{tot}}^{(\text{spec})} = \frac{1}{2} m L_{\text{pp}} + L. \quad (3)$$

The unknown integer number m of covered pulse intervals L_{pp} can be determined with off-the-shelf distance ranging instrumentation since the accuracy needs to be no better than $L_{\text{pp}}/2 \approx 15$ cm for our 1 GHz comb repetition rate.

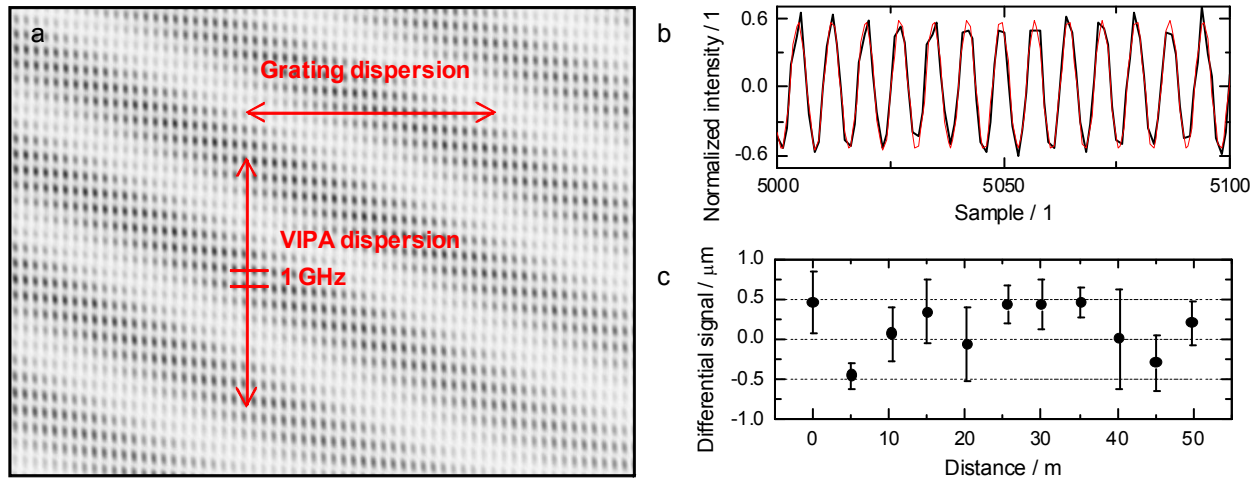

Figure 1. (a) Comb mode-resolved VIPA interferogram. (b) Unwrapped interference fringe for 20 m target distance. (c) Comparison of the mode-resolved spectral distance measurements with a fringe counting displacement interferometer⁵.

In order to establish a baseline for the instrumental accuracy of this spectral interferometry scheme, a comparison measurement with a commercial fringe counting heterodyne displacement interferometer was performed. The differential data analysis of simultaneously taken samples at various target distances compensates, to some extent, ambient air refractive index fluctuation. (The uncertainty of ambient atmospheric conditions is a major limitation for high accuracy optical distance measurement and not considered here to more detail.) Figure 1(c) shows measurement results for up to 50 m target distance. The agreement of the two distinct interferometer system readings is within ± 500 nm (5 samples average each), notably across the full distance range. The measurement accuracy is, supposedly, limited by vibrational perturbation of the moveable carriage with the target retro-reflector and by insufficient sampling synchronization. At 50 m distance the two instruments agreed with 10^{-8} precision.

2.2 Many wavelengths homodyne interferometry

By means of a diode laser together with an auxiliary bench wavelength meter, we establish a single frequency marker in order to *absolutely* calibrate the VIPA comb spectra. The wavelength meter has better than 150 MHz accuracy, sufficient to remove the comb mode ambiguity, i.e. the mode index p then is exactly known for every single recorded comb mode. With the repetition frequency f_{rep} and offset frequency f_0 stabilized to the atomic clock any frequency, i.e. wavelength λ_p in the VIPA spectrum is known with high accuracy. This absolute wavelength information allows evaluating the interferogram fringe phase ϕ_p as a homodyne length readout L_p for every single of thousands of wavelengths λ_p ,

$$L_{\text{tot},p}^{(\text{hom})}(\lambda_p) = \left(q_p + \frac{\Phi_p}{2\pi} \right) \frac{\lambda_p}{2n_p}, \quad (4)$$

with air phase refractive index n_p and an integer optical wavelength count number q_p . The evaluation of the dispersive spectral path length, $L_{\text{tot}}^{(\text{spec})}$, provides the resource for exactly determining the absolute distance count index q_p for the much higher optical wavelength scale resolution of the homodyne evaluation, $L_{\text{tot},p}^{(\text{hom})}$. The latter offers also improved statistics due to the large number of contributing wavelengths λ_p . Supposedly, the achievable measurement uncertainty for the homodyne evaluation is smaller as compared with the dispersive spectral one. In Eq. (4), the uncertainty of the measured phase Φ_p scales with the optical wavelength λ_p , whereas Eq. (2) can be rewritten⁵ to scale L with a synthetic wavelength $\Lambda = c/f_{\text{rep}}$, i.e. the separation between adjacent comb pulses which is much larger than λ_p . (Note, that it is the *relative* scale of the comb mode spacing f_{rep} in the VIPA image patterns that is used to evaluate the phase differential in Eq. (2).) Due to mechanical instability of the measurement bench and due to ambient air refractive index variability, we could not benefit from this smaller measurement uncertainty. The estimated total measurement uncertainty with a 95 % coverage ($k = 2$) is 0.75 μm for the results shown in Figure 1(c), whereas the homodyne evaluation leads to 0.69 μm .

3. INSTRUMENTAL ADAPTIONS TOWARD FIELD APPLICABILITY

3.1 Repetition rate multiplication by a comb filter cavity

In the framework of a European metrology research project¹⁶, we currently investigate instrumental aspects to foster applicability of the mode-resolved frequency comb distance measurement in a portable manner, under outdoor field conditions and with a range beyond the hitherto demonstrated 50 m.

An important advance would be the use of a more compact, robust and lower cost comb source, such as commercially available fiber lasers. Even more compact will be systems based on chip-scale micro cavities^{17,18} or fully integrated photonic comb sources¹⁹. Fiber laser combs typically have relatively small, 100 MHz level repetition rate, i.e. frequency mode separation. In order to individually resolve those modes, it is necessary to filter the comb to a larger mode separation, equivalent to a repetition rate multiplication to larger values. Such comb filtering may also be a convenient asset for sources with GHz level repetition rate, as even larger mode separation relaxes the resolving power requirements for the spectral interferometry. In consequence, the relatively costly VIPA equipment can be replaced by a simple grating spectrometer.

We have implemented a mode filtering cavity, targeting a transmitted comb mode separation adjustable in a range from 20 GHz to 100 GHz. A detailed description of this filter cavity set-up together with a performance investigation at hand of the VIPA spectrometer is reported in Lešundák *et al.*¹³. A close-up of this cavity is shown in Figure 2(b).

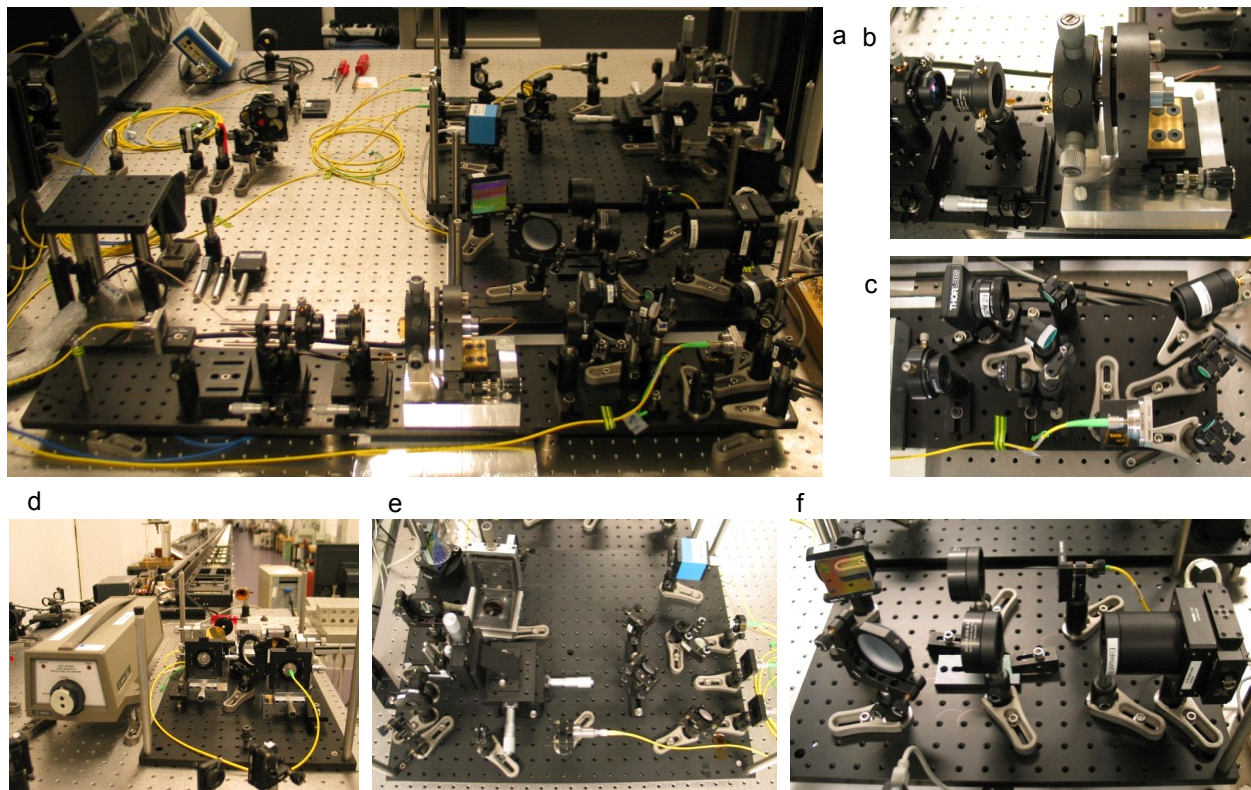

Figure 2. (a) Overview of the fiber coupled instrumentation breadboards with filter cavity, grating and VIPA spectrometer. The comb source system is out of view to the left. (b) Filter cavity with mode matching lenses. (c) Fiber coupling of cavity transmitted filtered light toward the interferometer head. Pick up of low power lock detection and monitor signals with PBS cube. (d) Interferometer head with source fiber attached and target corner cube reflector, yet on the table for alignment purposes, to be mounted on the carriage of the 50 m rail bench visible in the background. Heterodyne interferometer to the left for measurement comparison. (e) VIPA spectrometer, hosting also a flip-mirror multiplexing distribution to either VIPA or (f) grating spectrometer. Note that in use, the VIPA camera is locally shielded against ambient light with a black cardboard box whereas the grating spectrometer breadboard is fully covered by a black foam board shielding box.

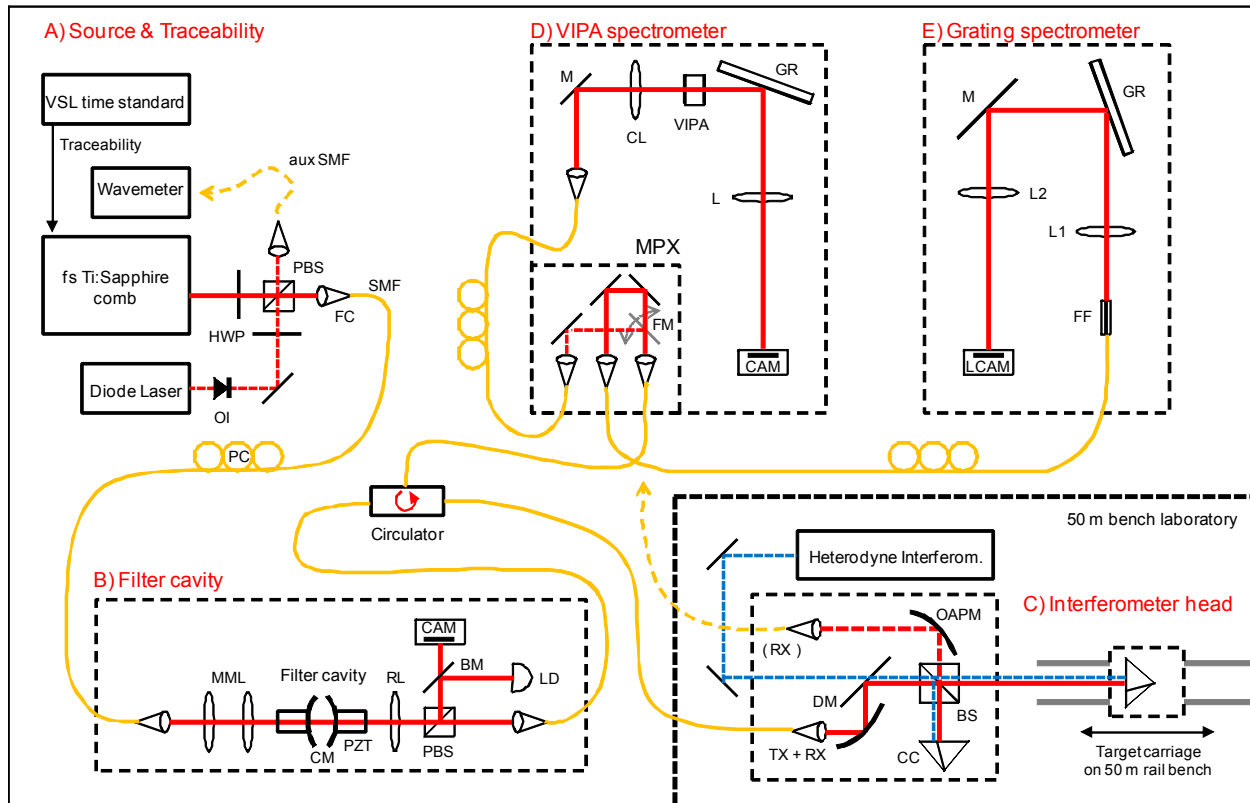

Figure 3. Optical scheme. **(A) Source & Traceability:** optical isolator (OI), half-wave plate (HWP), polarizing beam splitter (PBS), single mode fiber (SMF), auxiliary SMF toward wavemeter or to direct un-filtered comb toward spectrometers (aux SMF), fiber collimator (FC), polarization controlling fiber loops (PC). **(B) Filter cavity:** mode matching lenses (MML), concave cavity mirrors (CM), piezo actuators (PZT), re-collimation lens (RL), backside-polished mirror (BM), transmission monitoring camera (CAM), lock photo detector (LD). **(C) Interferometer head:** Source (TX) and receiver (RX) ports, off-axis parabolic mirrors (OAPM), dichroic mirror (DM), (non-polarizing) beam splitter (BS), corner cube retro reflectors (CC). **(D) VIPA spectrometer:** multiplex detection selection (MPX), flip mirror (FM), mirror (M), cylindrical lens (CL), grating (GR), re-imaging lens (L). **(E) Grating spectrometer:** fiber connector ferrule (FF), collimating lens (L1), re-imaging lens (L2), line camera (LCAM).

The cavity is formed by two concave dielectric broadband laser mirrors (820 nm central wavelength, $R = 0.99$ reflectance, 50 mm radius of concave curvature). The targeted $FSR = c/(2nL_{cav}) = 20$ GHz corresponds to a mirror separation of $L_{cav} = 7.5$ mm, which provides a basic filtered comb mode separation equal to this FSR . Higher filter ratios are adjusted by means of shorter cavity length and by a Vernier selection of the resonance condition for the inserted 1 GHz comb source. The relatively low cavity finesse, $F = \pi\sqrt{R}/(1-R) \approx 300$, is a compromise in view of the filter selection range and the filtered mode suppression. The cavity resonance linewidth is approximately 100 MHz FWHM. The cavity is kept thermally stable by local ambient shielding with a foam cover and is locked to resonance by means of a lock-in detection scheme. Either of the mirrors is mounted with a PZT actuator, used for frequency scanning search of a lock set-point and small sinusoidal frequency modulation for phase sensitive lock-in amplifier detection of the comb transmission resonance, respectively. The PID conditioned error signal is fed back to one of the actuators to lock the cavity on the selected resonance.

3.2 Fiber coupled modular experimental setup

Field use equipment should preferentially be portable. We installed modular sections of the instrumentation on breadboards that are interconnected with optical single mode fibers (SMF), see Figure 2(b) filter cavity with (c) lock detection, (d) interferometer head, (e) VIPA spectrometer and (f) grating spectrometer. Not shown in the pictures is a fiber circulator that allows the interferometer signal return from the head toward the spectrometers (see Figure 3). Using

SMF, we approximate any desired light polarization state by means of twisted fiber loop sections, for instance for the pick-up of a small fraction of the filtered comb spectrum by means of a small polarizing beam splitter cube (PBS) toward the lock detection and transmission monitor, see Figure 2(c).

The interferometer head is located with the VSL 50 m measurement rail bench, next door to the comb source laboratory. 10 m SMF link the head with the filtered comb source and the detection breadboards. In sake of return fiber coupling efficiency for long measurement distances up 600 m, we need a wide collimated source beam. To this purpose we are currently setting up the head with off-axis parabolic gold mirrors (101.6 mm focal length) to directly collimate the output from a fiber connector ferrule end face to a wide beam (5 μm mode field diameter in fiber, $NA = 0.13$, collimated to 26 mm $1/e^2$ intensity beam diameter). The signal can be returned either in a separate fiber or through the source fiber with a circulator at the laser set-up for coupling toward the spectrometer breadboards. In a polarizing configuration (beam splitter cube then to be replaced with a polarizing one, and polarizer and optional quarter wave retarders in signal and reference beams to be added, not shown in Figures 2 and 3), the system can be made compatible for simultaneous displacement measurement with a commercial heterodyne displacement interferometer⁵.

The VIPA spectrometer corresponds to the previously used set-up⁵, apart from a shorter focal length (300 mm) re-imaging lens, in sake of fitting within the breadboard envelope. The newly set up grating spectrometer (see also Figure 3) uses the source fiber connector ferrule as an entrance slit (5 μm mode field diameter). The collimated light (achromat doublet lens L1, 100 mm focal length) exposes in grating incidence a grating (holographic, 1800 lines/mm) and is re-imaged with a second lens (achromat doublet lens L2, 200 mm focal length) on a CCD line camera sensor (3000 pixels, 7 μm pixel pitch, 200 μm pixel width). This configuration provides sufficient resolution to distinguish 20 GHz separated filtered comb modes, while capturing the full spectral range of the comb spectrum (approximately 20 nm wide).

3.3 Experimental investigation of filter cavity and mode resolving grating spectrometer

The performance of the filter cavity instrumentation was previously investigated at hand of the VIPA spectrometer¹³, before being relocated to the breadboard. Here, we discuss more recent observations together with the new grating spectrometer. Figure 4(a,b) shows the response of the grating spectrometer to the auxiliary single frequency DFB diode laser, yet without the filter cavity. No significant out-of-band stray light is present with the shielded breadboard. The (local) wavelength, i.e. frequency scale displayed in the top axis of the graphs was established by means of tuning the diode laser for several emission frequencies and simultaneous wavelength meter read out, see Figure 4(c). The spectrometer laser line resolution is 17 GHz FWHM.

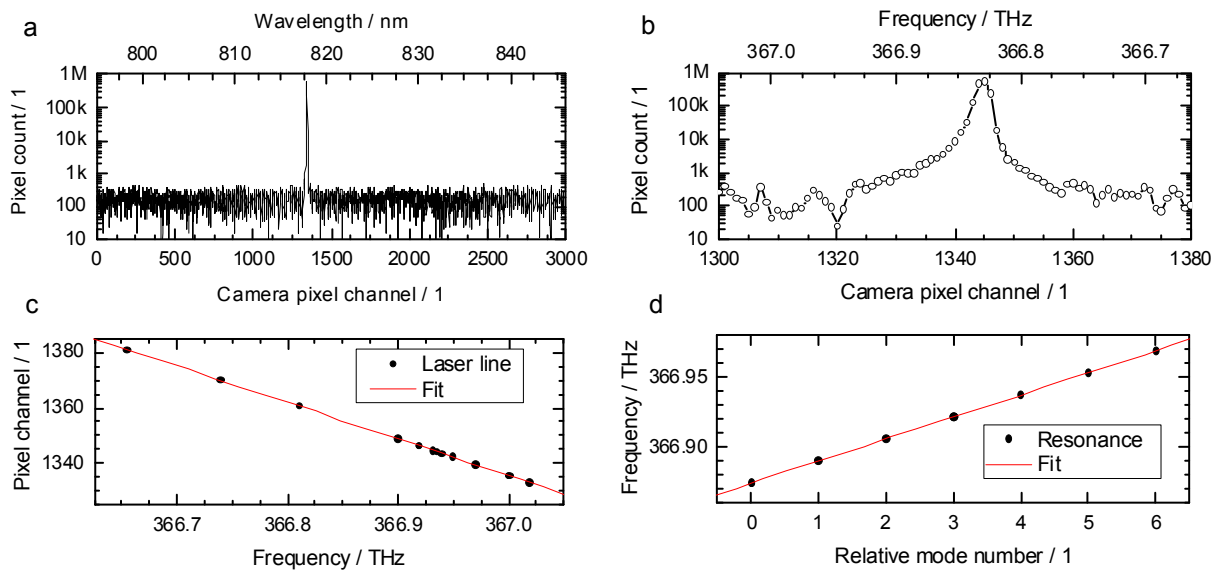

Figure 4. (a, b) Diode laser single line response of the grating spectrometer. Scale on upper axis as from (c) fit to various diode laser set points, referenced to the wavelength meter. (d) Frequencies of successive resonant filter cavity modes. The fitted slope, i.e. mode frequency separation provides a FSR estimate.

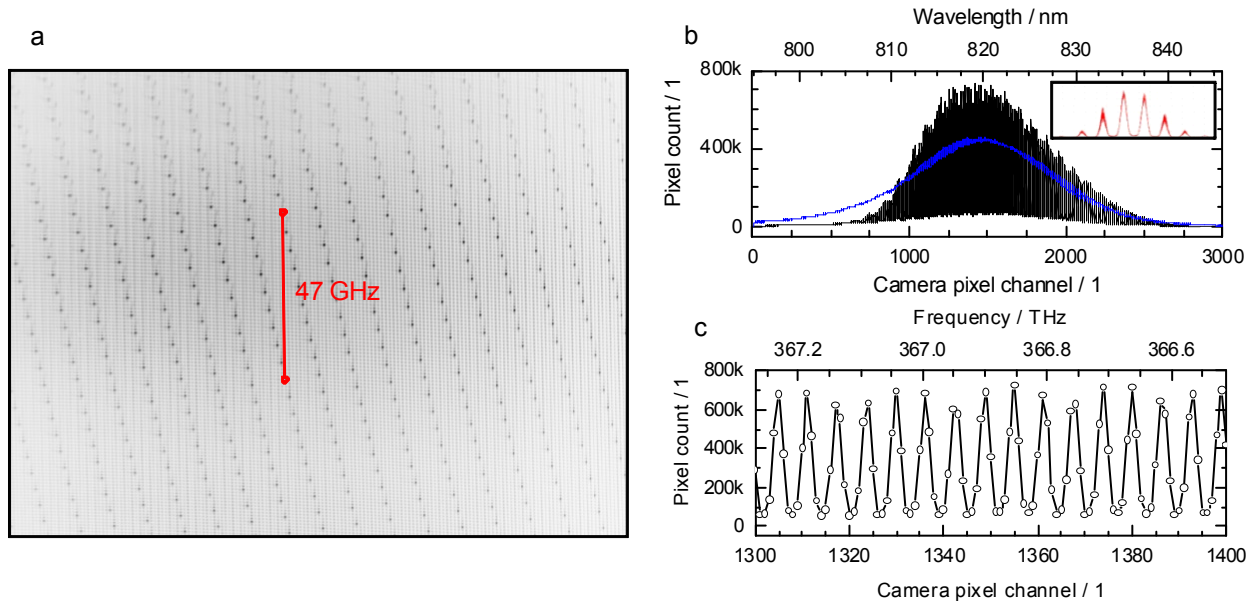

Figure 5. Filter cavity pre-set to ≈ 15.8 GHz FSR , resulting in 47 GHz filtered repetition rate when locked to resonant comb transmission. **(a)** VIPA spectrum: dark dots from filtered cavity transmission, overlaid with a separate spectrum from the non-filtered direct 1 GHz comb source. **(b, c)** Grating spectra: 47 GHz filtered spectrum (black dense fringes) and non-filtered direct comb spectrum (blue curve). The inset shows a filtered spectrum for slightly different cavity FSR set-point (red curve).

The filter cavity can conveniently be pre-set in length by manually dialing the diode laser frequency through observed cavity resonances and recording the respective wavelength meter readings, see Figure 4(d). The frequency increments between the resonances give the FSR , i.e. the approximate length $L_{cav} \approx c/(2 FSR)$. For the shown ad hoc cavity set point we find $FSR \approx 15.8$ GHz and $L_{cav} \approx 9.5$ mm.

Figure 5 shows an example for a relatively low filter ratio with 47 GHz mode spacing for the 15.8 GHz FSR pre-set cavity (thus in lock kept at 47/3 GHz). Both the VIPA and grating spectrum are shown. For identification of the actually established filter ratio, in Figure 5(a) a direct comb VIPA spectrum image is overlaid by software with the filtered cavity output spectrum. Figure 5(b) shows the filtered grating spectrum together with a direct comb spectrum. In the latter no individual comb modes are resolved. The apparent small fringing depends on subtle tilt alignment of the line camera and other optics of the grating spectrometer, possibly caused by interference from a protective window of the camera. The filtered spectrum doesn't cover the full comb bandwidth. The Ti:Sapphire based comb source is tuned by dispersive properties to a non-zero offset frequency $f_0 = 180$ MHz. In contrast, the air path filter cavity may have close to zero offset frequency. In resonant lock of the filter cavity to the inserted comb spectrum, a central range of neighboring comb modes transmit, according to the ≈ 100 MHz resonant line width of the filter cavity. However, due to the difference in offset frequency, there will be a mismatch in comb repetition rate and filter cavity FSR , which will cause the modes in the wings of the comb spectrum to incrementally shift out of resonance and thus being extinguished. For slightly different cavity length adjustments, modes shift in resonance again and various Moiré fringing envelopes of the spectrum are observed, occasionally reaching across the full comb spectrum, see inset of Figure 5(b) for an example.

Figure 6 shows a very large filter ratio with 315 GHz mode spacing. Non-suppressed side modes are apparent then. Nevertheless, this may be not detrimental for use with the above discussed ranging interferometry method as the required resonance peak intensities can still be read out in order to establish the interference fringe, cf. Figure 1. Note also, that the integral filtered beam power is obviously less than for smaller filter ratios. In practical terms this complicates beam alignment, fiber coupling and lock signal detection. It does not diminish the recorded filtered mode signal counts though.

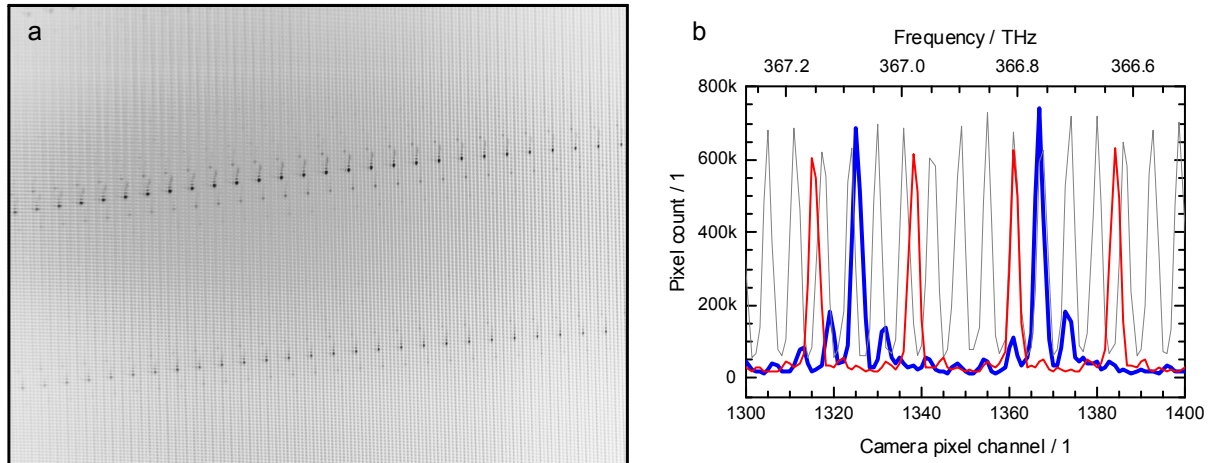

Figure 6. High filter ratio (315 GHz mode spacing) with non-suppressed intermediate modes. **(a)** VIPA spectrum. Filtered comb overlaid in image with direct comb. **(b)** Grating spectrum. Thick blue curve for high filter ratio from (a), red curve for other filter ratio (172 GHz), and thin gray curve from Figure 5 set-point (47 GHz).

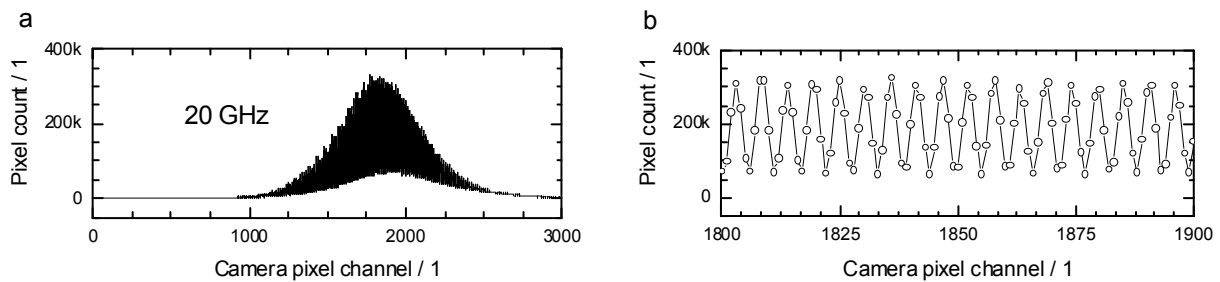

Figure 7. **(a, b)** 20 GHz filtered comb with shorter cavity.

The cavity design, although yet prone to acoustic vibrational perturbation, is relatively handsome for course manual filter ratio pre-tuning. Using a caliper reading of the mirror mount separation at the above 15.8 GHz *FSR* setting allowed to shorten the cavity by 1.9 mm and thus aiming for the 20 GHz filter regime. The final filter state lock point was then looked up by means of the cavity mirror PZT tuning, see Figure 7. The grating spectrometer indeed resolves this low filter ratio, though with less fringe visibility. The mode matching lenses for the comb insertion into the cavity were not particularly optimized or adapted in either of the cavity settings. Also fiber coupling after the cavity was not re-optimized, which may explain the smaller signals. Note that the grating spectrometer optics were re-aligned and thus the scale and the offset of the grating pixel channels differ from Figure 6.

With 100 mW comb source power delivered by SMF to the filter cavity breadboard, we have typically about 100 μ W power of the 47 GHz filtered comb delivered by SMF directly (yet without interferometer head) to the detection breadboards in this, not fully optimized, cavity alignment state. Return coupling efficiency from the interferometer head may be only a few percent due to beam divergence, fiber coupling and optical component losses. Despite this modest return efficiency, we expect only a few milliseconds of spectrometer line camera exposure time necessary to retrieve useful spectral interferograms.

4. CONCLUSIONS

Using a femtosecond optical frequency comb source in combination with a frequency mode-resolved comb detection, we have investigated a combined spectral and multi-wavelength homodyne interferometry scheme for high accuracy absolute distance measurement. In comparison with a conventional displacement interferometer system this method agreed within 500 nm, i.e. with 10^8 precision for a target distance up to 50 m. Aiming for portability and potential field application with up to 600 m range, we re-configured the instrumentation on modular breadboards and with optical fiber interconnects. A comb filter cavity was set up that multiplies the 1 GHz pulse repetition rate, i.e. the comb frequency spacing, adjustable in a range from 20 GHz to beyond 100 GHz. This allows for replacing the relatively costly virtually imaged phased array spectrometer set-up that was necessary for the 1 GHz comb mode resolution by a simple grating spectrometer. We discuss the performance of the filter cavity and the grating spectrometer. The interferometer head for several 100 m measurement range capability is currently being implemented and first spectral interferometry signals are being investigated with the refurbished measurement instrumentation.

ACKNOWLEDGMENTS

This work was funded through the European Metrology Research Program (EMRP), Project SIB60 "Surveying"¹⁶ and the Dutch Ministry of Economic Affairs. The EMRP is jointly funded by the EMRP participating countries within EURAMET and the European Union.

REFERENCES

- [1] Diddams, S. A., "The evolving optical frequency comb [invited]," *J. Opt. Soc. B* 27, B51 (2010).
- [2] Joo, K.-N. and Kim, S.-W., "Absolute distance measurement by dispersive interferometry using a femtosecond pulse laser," *Opt. Express* 14, 5954 (2006).
- [3] Cui, M., Zeitouny, M. G., Bhattacharya, N., Van den Berg, S. A., Urbach, H. P. and Braat, J. J. M., "High-accuracy long-distance measurements in air with a frequency comb laser," *Opt. Lett.* 34, 1982 (2009).
- [4] Van den Berg, S. A., Persijn, S. T., Kok, G. J. P., Zeitouny, M. G. and Bhattacharya, N., "Many-wavelength interferometry with thousands of lasers for absolute distance measurement," *Phys. Rev. Lett.* 108, 183901 (2012).
- [5] Van den Berg, S. A., Van Eldik, S. and Bhattacharya, N., "Mode-resolved frequency comb interferometry for high-accuracy long distance measurement," *Sci. Rep.* 5, 14661 (2015).
- [6] Diddams, S. A., Hollberg, L. and Mbele, V., "Molecular fingerprinting with the resolved modes of a femtosecond laser frequency comb," *Nature* 445, 627 (2007).
- [7] Gohle, C., Stein, B., Schliesser, A., Udem, Th. and Hänsch, T. W., "Frequency comb Vernier spectroscopy for broadband high-resolution, high-sensitivity absorption and dispersion spectra," *Phys. Rev. Lett.* 99, 263902 (2007).
- [8] Braje, D. A., Kirchner, M. S., Osterman, S., Fortier T. and Diddams, S., "Astronomical spectrograph calibration with broad-spectrum frequency combs," *The Europ. Phys. J. D* 48, 57 (2008).
- [9] Steinmetz, T., Wilken, T., Araujo-Hauck, C., Holzwarth, R., Hänsch, T. W., Pasquini, L., Manescau, A., D'Odorico, S., Murphy, M. T., Kentischer, T., Schmidt, W. and Udem, T., "Laser frequency combs for astronomical observations," *Science* 321, 1335 (2008).
- [10] Chang, G., Li, C.-H., Phillips, D. F., Szentgyorgyi, A., Walsworth, R. L. and Kärtner, F. X., "Optimizing of filtering schemes for broadband astro-combs," *Opt. Express* 20, 24987 (2012).
- [11] Coddington, I., Swann, W. C. and Newbury N. R., "Coherent multiheterodyne spectroscopy using stabilized frequency combs," *Phys. Rev. Lett.* 100, 013902 (2008).
- [12] Ideguchi, T., Poisson, A., Guelachvili, G., Piqué, N. and Hänsch, T. W., "Adaptive real-time dual-comb spectroscopy," *Nat. Commun.* 5, 3375 (2014).
- [13] Lešundák, A., Šmíd, S., Voigt, D., Čížek, M., Van den Berg, S. A. and Číp, O., "Repetition rate multiplication of a femtosecond frequency comb," *Proc. SPIE* 9450, 94501L (2015).
- [14] Kirchner, M. S., Braje, D. A., Fortier, T. M., Weiner, A. M., Hollberg, L. and Diddams, S. A., "Generation of 20 GHz, sub-40 fs pulses at 960 nm via repetition-rate multiplication," *Opt. Lett.* 34, 872 (2009).

- [15] Steinmetz, T., Wilken, T., Araujo-Hauck, C., Holzwarth, R., Hänsch, T. and Udem, T., “Fabry-Pérot filter cavities for wide-spaced frequency combs with large spectral bandwidth,” *Appl. Phys. B* 96, 251 (2009).
- [16] Joint Research Project SIB60, “Metrology for long distance surveying,” Euramet EMRP Call 2012 SI Broader Scope, <http://www.euramet.org/research-innovation/emrp/emrp-calls-and-projects/emrp-call-2012-industry-si-broader-scope-open-excellence/>, see also project website <http://www.emrp-surveying.eu>.
- [17] Del’Haye, P., Schliesser, A., Arcizet, O., Wilken, T., Holzwarth, R. and Kippenberg, T. J., “Optical frequency comb generation from a monolithic microresonator,” *Nature* 450, 1214 (2007).
- [18] Papp, S. B., Beha, K., Del’Haye, P., Quinlan, F., Lee, H., Vahala, K. J. and Diddams, S. A., “Microresonator frequency comb optical clock,” *Optica* 1, 10 (2014).
- [19] Latkowski, S., Moskalenko, V., Tahvili, S., Augustin, L., Smit, M., Williams, K. and Bente, E., “Monolithically integrated 2.5 GHz extended cavity mode-locked ring laser with intracavity phase modulators,” *Opt. Lett.* 40, 77 (2015).