

**Detection of cyber attack in smart grid
A Comparative Study**

Xiao, Junjie; Wang, Lu; Qin, Zian; Bauer, Pavol

DOI

[10.1109/PEMC51159.2022.9962902](https://doi.org/10.1109/PEMC51159.2022.9962902)

Publication date

2022

Document Version

Final published version

Published in

2022 IEEE 20th International Power Electronics and Motion Control Conference, PEMC 2022

Citation (APA)

Xiao, J., Wang, L., Qin, Z., & Bauer, P. (2022). Detection of cyber attack in smart grid: A Comparative Study. In *2022 IEEE 20th International Power Electronics and Motion Control Conference, PEMC 2022* (pp. 48-54). (2022 IEEE 20th International Power Electronics and Motion Control Conference, PEMC 2022). IEEE. <https://doi.org/10.1109/PEMC51159.2022.9962902>

Important note

To cite this publication, please use the final published version (if applicable).
Please check the document version above.

Copyright

Other than for strictly personal use, it is not permitted to download, forward or distribute the text or part of it, without the consent of the author(s) and/or copyright holder(s), unless the work is under an open content license such as Creative Commons.

Takedown policy

Please contact us and provide details if you believe this document breaches copyrights.
We will remove access to the work immediately and investigate your claim.

Green Open Access added to TU Delft Institutional Repository

'You share, we take care!' - Taverne project

<https://www.openaccess.nl/en/you-share-we-take-care>

Otherwise as indicated in the copyright section: the publisher is the copyright holder of this work and the author uses the Dutch legislation to make this work public.

A Review of the Key Technical and Non-Technical Challenges for Sustainable Transportation Electrification: A Case for Urban Catenary Buses

1st Ibrahim Diab
*Electrical Sustainable
Energy department
Technische Universiteit Delft
(TU Delft)
Delft, The Netherlands
i.diab@tudelft.nl*

2nd Gautham Ram Chandra Mouli
*Electrical Sustainable
Energy department
Technische Universiteit Delft
(TU Delft)
Delft, The Netherlands
G.R.ChandraMouli@tudelft.nl*

3rd Pavol Bauer
*Electrical Sustainable
Energy department
Technische Universiteit Delft
(TU Delft)
Delft, The Netherlands
P.Bauer@tudelft.nl*

Abstract—The transport sector has been increasing rather than decreasing its CO₂ emissions, and its sustainable electrification faces a number of technical and non-technical challenges. This paper investigates these challenges, namely those of the grid load demand modelling, renewables integration, the present infrastructure limitations, and the policy/non-technical challenges. In synthesis, the suggested vision for the future sustainable urban bus network is presented as a catenary grid running In-Motion-Charging trolleybuses, with integrated PV, EV chargers, and stationary storage systems. The future grid must involve external players such as the DSO/TSO and research/academic institutions, with a dedicated coordination body, from pre-tendering all the way to daily operations.

Index Terms—Sustainable, Transportation, Electric Mobility, Storage, Renewable Energy

I. INTRODUCTION

While the world moves toward a more sustainable society, the transport sector, unfortunately, is a growing sector in terms of CO₂ emissions [1, 2]. The pressure is inevitably increasing on local authorities to shift toward more sustainable solutions in their public transport networks.

The electrification of urban public bus transport is already growing in momentum, and predicts a market penetration of up to 75% by 2030 as battery technologies become more advanced [3–7]. Trolleybuses are destined to (re)become a key player, after decades of expansion and contraction that saw many of their networks going out of commission [8, 9]. Their electrical grids are becoming increasingly more sophisticated with the inclusion of smart grid technologies [10], renewable energy sources (RES) [11–20], on-board and/or off-board storage [21–25], electric-vehicle (EV) chargers [15, 26–28], and In-Motion-Charging (IMC) buses [8, 29, 30].

A. The Challenges for Transportation Electrification

The sustainability of electric transport depends on the source of its electrical power. Many challenges face sustainable transportation electrification. This paper focuses in particular

on electrical urban buses, and in particular trolleybuses, and the following key challenges that they face:

- i. The Challenge of the Modelling of Trolleybuses and Trolleygrids
- ii. The Challenge of the Mono-functionality of the Transportation Network (the RES problem)
- iii. The Challenge of the Present Infrastructure Limitations
- iv. The Challenge of the Policy Limitations

B. Paper Structure

This paper started with an introduction to sustainable electrical bus networks and listing the key challenges facing them. Section II compares the different electric bus types and justifies the focus on catenary buses for the rest of the paper. Sections III to VI address the four listed challenges each, and section VII provides conclusions and recommendations.

II. COMPARISON OF ELECTRICAL BUS TYPES

A. The Trolleybus and its Trolleygrid

The trolleybus, like trams, is an electric vehicle supplied by a catenary (overhead lines). A trolleygrid is divided into low voltage substations that feed one or more sections, as shown in figure 1. From the Low Voltage AC (LVAC), the substation (step-down transformer and a rectifier) supplies the buses on its sections via feeder cables (e.g. FC1 in figure 1), at 600-750Vdc (V_{SN}), depending on the substation and the trolleybus city. The minimum bus voltage for operation is 400V [5, 31], consequently, the trolleybus lines are divided into isolated sections to limit the resistive voltage drops in the catenary and transmission losses, and for reasons such as fault protection. The sections are from a few hundreds up to 2 km in length, depending on the trolleygrid city. Trolleybuses consume about 70 kW of traction power during regular driving but can reach power peaks above 300 kW while accelerating. When a trolleybus brakes, the available regenerative braking power can be as high as 200 kW. If the braking trolleybus has an on-board storage system (also known as a dual-source

trolleybus [22, 24, 32, 33]), it can harvest this braking energy to be later used while accelerating. In the absence of on-board storage, this power can be fed to buses on the same section, on a connected section under the same substation busbar (Bus1 and Bus2 in figure 1), or wasted in on-board braking resistors [22, 24, 31]. The braking energy cannot be sent back to the LVAC grid because of the unidirectional rectifiers at the substation.

A new generation of trolleybuses, namely the In-Motion-Charging or IMC bus, combines the advantage of a trolleybus and of a battery electric bus (e-bus) [8, 31, 34–38]. IMC buses are equipped with an on-board battery that is charged while the bus is in-motion. This gives the IMC bus both the route and range flexibility of an e-bus, but with a smaller battery size that needs to cover one round trip in battery-mode rather than a full day operation.

In the context of electrification of diesel vehicles, replacing them with IMC buses is useful for bus routes that already pass under the trolleygrid catenary. In this manner, the IMC battery can be charged from a shared infrastructure, and ultimately drive the bus in areas that do not pass under the catenary.

B. Battery, Hydrogen, and Trolleybuses

Table I compares the different types of electric buses in terms of charging power, battery size, and system cost, among others. The table argues that while the cost of both IMC and conventional trolleybuses are high, their advantages in battery size, charging power, and flexibility come only to complement their advantage of high potential for RES integration. The merit of catenary network is that the installed RES system, like solar PV, encounters a transportation load for an extended period of time. This minimizes the need for energy storage systems. On the other hand, systems like Flash Charging would require massive amounts of energy storage to collect the PV energy and deliver it in the short time of a flash charge. This comes at both investment costs and energy inefficiency. Moreover, the catenary system has the potential then to integrate other smart grid functionalities like EV chargers into its infrastructure. Thereby the costs of multiple systems are shared, and the excess braking energy of buses can be shared with other loads nearby.

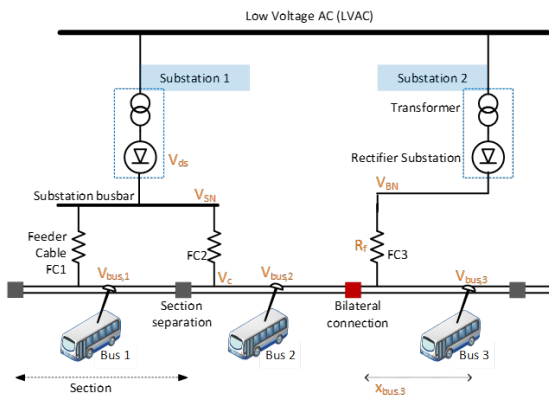

Fig. 1: The Trolleygrid and its components

C. Closer look: Conventional Trolleybuses versus IMC Trolleybuses

The IMC bus differs from the trolleybus with an on-board energy storage system (OESS) in that the OESS is a passive storage component that is only used to store excess braking energy, while the IMC battery is actively charged from sections of the trolleygrid called the charging corridors.

The trolleybus consumes typically 1.5kWh/km for traction, and up to an additional 1kWh/km for auxiliary systems such as the heating and air conditioning. Thanks to the inherent presence of a battery, the IMC bus is able to recuperate most of its regenerative braking energy, worth typically a third of the average traction demand (1.5kWh/km) [5, 18, 31]. The IMC bus requires therefore around 2kWh/km in cold, winter weather conditions for its traction and auxiliaries. However, the battery of the IMC bus has a demanding load on the trolleygrid that far outweighs its braking energy recuperation benefit. This is because the IMC bus needs to pick up enough energy from the charging corridor length to cover the battery-mode route, typically at a length ratio of 1:2 or 1:3. For example, in the case 1:3, the corridor is 25% of the total route and thereby the IMC bus would consume a minimum of 4 times its average power under the catenary.

As explained in [30], the energy picked up by the IMC bus, E_{pu} , per kilometer of the charging corridor, l_c , can be described as

$$\frac{E_{pu}}{l_c} = \eta_{ch} \left[\Psi \cdot \frac{1}{\bar{v}_m} + \Pi \left(\frac{1}{\bar{v}} - \frac{1}{\bar{v}_m} \right) \right] \quad (1)$$

Where η_{ch} is the charging efficiency of the battery system, Ψ and Π are the moving and standing battery-charging powers, respectively, \bar{v} is the bus average speed and \bar{v}_m is the bus average moving speed (excluding the stop times). The IMC bus uses two charging powers, Ψ and Π , because it should not overheat the overhead cable by drawing too much current when standing still [18].

Considering average values from literature [5, 18, 31] of $\eta_{ch} = 0.95$, $\bar{v}_m = 24\text{km/hr}$, and $\bar{v} = 16\text{km/hr}$, figure 2 estimates the average energy picked up from the catenary per

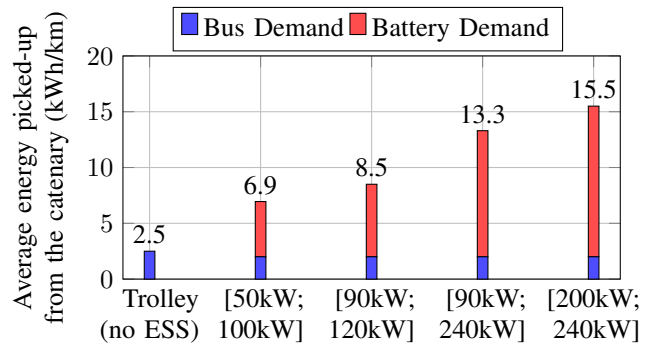

Fig. 2: Comparison of average energy picked-up from the catenary in [kWh/km] for a trolleybus without on-board storage system and an IMC bus with different combinations of standing and moving battery-charging powers [Π , Ψ]

TABLE I: Comparison of Electric Bus types and charging methods [5, 11, 18, 39–47]

	Battery Electric Bus (BEB)				Fuel Cell Bus	Trolleybus	
	Overnight/ Slow-charging	Opportunity Charging/ Fast Charging	Flash Charging/ Ultra-fast Charging	Battery Swap	(FCB)	Conventional	In-Motion Charging (IMC)
Bus Power Source	On-board battery	On-board battery	On-board battery	On-board battery	Fuel cell and Battery/ Supercapacitor	Overhead cables	Overhead cables and on-board battery
Battery Size	Large, hundreds of kWhs	Medium, tens of kWhs	Small, few kWhs	Medium, tens of kWhs	Medium or Large	N/A	Medium, tens of kWhs
Battery Charging Power	Low 30-50 kW	Medium 50-350kW	High Up to 600kW	Low or Medium	Low or Medium	N/A	50-300 kW
Battery Charging Time	Hours	Minutes to Hours	Seconds to Minutes	~one minute (swap time)	Minutes to Hours	N/A	No extra time (in-motion)
Route Flexibility	Yes	Yes	Yes	Yes	Yes	No	Yes
Timetable Flexibility*	Yes	No	No	Yes	No	Yes	Yes
System Cost (Infrastructure, Buses, Operational costs for charging)	Moderate	Moderate	High	High	High	Very High	High (Lower with an existing catenary)
Potential for Local RES Supply	Low to Medium	Low (needs tens of kWhs of storage)	Very Low (needs hundreds of kWhs of storage)	Low to Medium	Low to Medium	Low to Medium, with potential for High**	Low to Medium, with potential for High**

*Ability to increase frequency of vehicles and/or reducing stop times to make up for delays

**Detailed in section IV-A

km for a few cases of typical $[\Pi, \Psi]$ combinations, in addition to its traction demand of 2 kWh/km. The IMC bus can demand from 3 to 6 times as much energy or average power from the grid as a trolleybus. Consequently, less capacity is left over for integrating other loads. The IMC is still more favorable in terms of lower infrastructure costs, and a reduction of overhead cables, to which the public opinion is typically hostile. A smart power management system for the IMC charging and the trolleygrid can prevent the capacity issues and already some sophisticated charging schemes are being developed [18].

III. THE CHALLENGE OF THE MODELLING OF TROLLEYBUSES AND TROLLEYGRIDS

The design of a sustainable, multi-functional transportation grid must start with a thorough understanding of its load power demand. However, this is not a straightforward task as explained in this section.

A. The Complexity of Predicting Trolleygrid Load Demand

Trolleybus and tram vehicles move with the unpredictable city traffic, and with unpredictable driver behavior [5, 31, 48]. The consequence is that the load power and location are hard to predict. For example, Bus 2 in figure 1 can be delayed enough that it is present with Bus 3 under Substation 2, creating an unpredicted high load demand. The extent of the erratic vehicle behavior can be observed in figure 3. Additionally, the Heating, Ventilating, and Air Conditioning (HVAC) demand of a trolleybus in a cold environment can be

as much as its traction demand, adding to the complexity of the load prediction [5, 11, 31, 48–50].

B. The Unpreparedness of the Existing Trolleygrid Models in Literature

The existing modelling works in literature tend to overlook some key aspects of the trolleygrid infrastructure such as feeder cable lines, HVAC demand, and the substation nominal voltage [5]. Table II summarizes these assumptions and the errors they can bring into the voltage and power calculations. This can have serious implications on the sizing, placement, and choice of RES systems and smart grid loads to be integrated in catenary networks. Consequently, this can affect the economical feasibility of these systems, and the reliability of their operation and dispatch/control schemes.

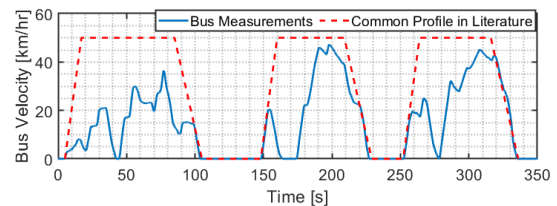

Fig. 3: Trolleybus velocity measurements from Arnhem, The Netherlands, compared to the trapezoidal velocity profile commonly found in literature while studying trolleygrids

TABLE II: Summary of the effect on the power and voltage calculation errors caused by common assumptions and models in literature and the comprehensive trolleybus grid model presented in [5]

Trolleygrid Parameter	Typical modelling assumptions made in literature	Effect of assumption (results of detailed analysis in [5])
Overhead Line Impedance	Assumed purely resistive, except in works such as [21] where it is taken as resistive-inductive	Can indeed be considered purely resistive for steady-state models
Overhead Parallel Lines	Ignored in works such as [23, 51], included in works such as [52–54]	If ignored, the line impedance could be as much as double its actual value (100% error)
Bus Auxiliaries Power	Ignored in works such as [15, 16, 23, 52, 55–60], included in works such as [49, 50]	If ignored, errors up to 55% in substation energy calculations
Bus Regenerative Braking	Ideally, implied that it is modelled but it is not correct to include it while simultaneously ignoring the auxiliaries demand such as in [15, 16, 23, 52, 55–60]	If ignored, errors as high as 34% in the substation power calculations
Section Feeder Cable	Only mentioned in works such as [32, 54, 61]	If ignored in zones of high power demand and/or long feeder cable lengths, errors above 15% in the power calculations and 50V for the minimum line voltage are expected
Bilateral Connections	Only mentioned in works such as [53, 62, 63]	If ignored, errors up to 25% in the substation power calculations
Substation Nominal Voltage	Typically assumed at a rounded-up nominal value of 650 or 700V such as in [23, 62, 64]	Particularly important for bilaterally connected substations because of the effect on the load-sharing ratio between them

IV. THE CHALLENGE OF THE MONO-FUNCTIONALITY OF THE TRANSPORTATION NETWORK (THE RES PROBLEM)

A. The Inherent Mismatch Between RES Generation and the Trolleygrid Load

Powering electrical transportation with renewables is vital to ensure low source-to-wheel emissions. The integration of RES in trolleygrids faces the key challenge of the mismatch between the load demand and RES generation. While this is a typical feature of systems of intermittent renewables, the problem is accentuated in transport networks by the complete absence of a load as an inherent consequence of the bus scheduling over fragmented and isolated infrastructure sections, as seen in figure 4. The figure shows how the substation load (blue) and the PV generation (red). At low traffic substations, like substation Q in the figure, the mismatch is far more pronounced as there could be only as much as one bus on the section and the PV system would not see a load in between vehicle arrivals. While this is less intense at high traffic substations like SS-D, the problem there become seasonal as the installed PV systems will either be relatively small and not provide in the winter, or large and have too much excess energy in the summer.

Works such as [11] detail RES placement and sizing possibilities in catenary networks and conclude indeed that the absence of a base load is a key bottleneck for the sustainability of a transport network. The best option without storage is found to be a hybrid PV/Wind system on the AC side (the city grid). In other words, the multi-functional transport grid is not only a synergetic opportunity, but a necessity for the sustainable development and supply of transportation grids.

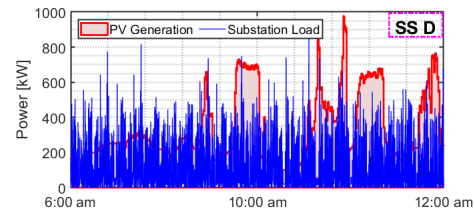

(a) Substation D (high traffic substation)

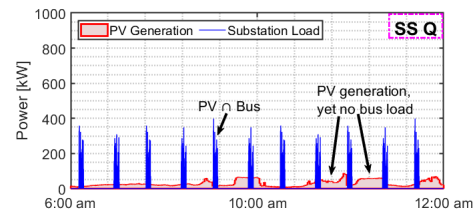

(b) Substation Q (low traffic substation)

Fig. 4: Mismatch in simulated PV generation and the bus load for two Arnhem substations

B. The Design Conflicts of the Future Transportation Grids

While the multi-functional grid is praised for its synergetic benefit to the sustainable transport grid of the future, its design choice becomes a challenge. Figure 5 shows the possible locations for a PV system and storage in a trolleygrid. These options are assessed in table III based a number of parameters regarding efficiency, harvesting of braking energy, and the assistance in the reduction of line voltage drops, among others. It is worth noting that the trolleybus with OESS is different than the IMC bus as the former has a small, passively charging battery from the braking energy, while the latter has a relatively large battery with an actively controlled charging power from the catenary.

Tables IV and V offer a weighted sum of the benefits graded

in table 5. The first table prioritizes the integration of more RES without storage, while the second table prioritizes the integration of more smart grid loads. It can be seen how the two solutions suggest extremely opposing placement suggestions. This urges stakeholders to thoroughly assess and discuss the multi-functional grid they want to see, and the limits of these multi-functional grids to be multi-objective.

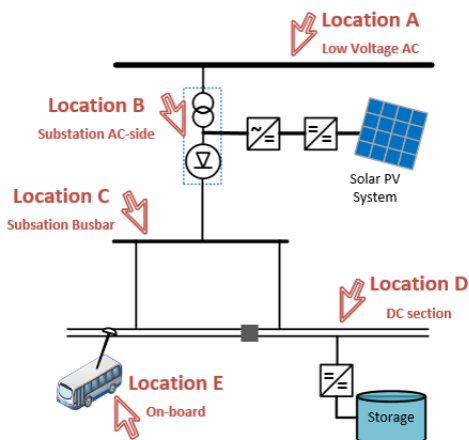

Fig. 5: Different PV and ESS placement possibilities

V. THE CHALLENGE OF THE PRESENT INFRASTRUCTURE LIMITATIONS

A. The Substation Nominal Voltage and Supply Zone Optimization

Previously, the substation nominal voltage was a trade-off design choice between only two parameters (figure 6). Lower substation voltages were preferred to allow for more efficient regenerative braking. This is a consequence of the over-voltage limitation on the buses that switches the braking resistor to protect the grid if the voltage rises above values around 720V. On the other hand, higher substation voltage are more preferred to reduce the line transmission losses. The result of this is that end-of-line substations (low traffic) typically have high voltages, while busy substations have a low voltage to maximize the sharing of the regenerative braking power.

When addressing the grid of the future, a third parameter should be considered: the minimum line voltage. A trolleybus typically shuts down if its voltage is as low as 400V, and it already starts curtailing its traction power below 500V, to protect from high current values [5]. Substation nominal voltage should then be re-assessed and raised to create more capacity for the integration of smart grid loads without braking the operational limits, and acknowledging the benefit these components would have as well on consuming the regenerative braking of buses.

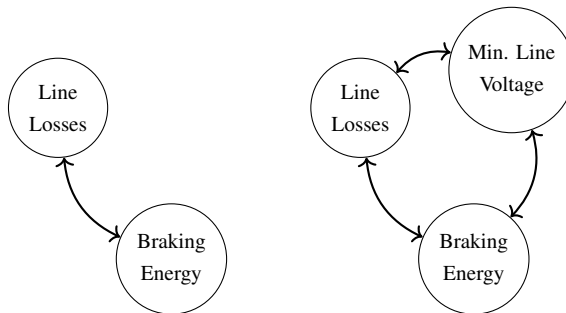

Fig. 6: The trade-offs considered when choosing the substation nominal voltage for conventional trolleygrids (left) and for the multi-functional trolleygrid of the future (right)

B. The Dilemma of On-board Storage Systems

Trolleybuses with on-board storage seem like a promising solution for transport grids: They harvest the braking energy and shave the acceleration power peaks at the source. This results in a passive reduction of line voltage drops as well, using cost-friendly systems as they are of only a few kWh [11, 18, 57].

The problem with OESS lies in two aspects: Its passive dis/charging behavior, and more importantly, its constant abandoning of the substation supply zone.

The first issue is that the buses become more exclusive in terms of their power demand: Not sharing braking energy and not demanding peaks from the substation. Both of these behaviors have then the consequence of reducing the bus load demand and accentuating even more the mismatch seen in cases such as figure 4b. The net benefit of these storage systems should then be further investigated.

More seriously, the on-board storage leaves when the bus leaves. The trolleygrid section is then left without a storage system, thereby neither solving the load absence issue of figure 4b, nor leaving an additional support for the grid in terms of active voltage support for smart grid loads.

It is worth noting that an active OESS system is not a solution either as these systems typically are of 1-3kWh in size, and therefore not suitable for actively taking in the PV excess energy on addition of their braking energy load. Increasing the battery size would simply move the trolleygrid toward the IMC with active charging scenario, which is indeed the preferred scenario, but is no longer the present-day case of a trolleybus with storage.

Further research into the comparison of on-board and off-board storage systems is urgently needed as this can be a serious investment risk for the future grids as stakeholders who are currently investing in on-board storage, might need additional investments in off-board storage systems for the feasibility of RES integration.

VI. THE CHALLENGE OF THE POLICY LIMITATIONS

A. Hesitation Toward Catenary Infrastructure Solutions (Costs and Public Opinion)

The trolleybus comes at a much higher infrastructure cost than an electric bus, with one kilometer of catenary costing

TABLE III: Comparison of the outcomes of different placement locations of PV and Storage in DC Trolleybus grids

	Possibility of large PV system with high Utilization	Regenerative braking energy recuperation	PV to Bus efficiency	ESS to Bus efficiency	PV to ESS efficiency	PV reducing line voltage drops	ESS reducing line voltage drops	Independence of PV from storage	Independence of PV from AC grid
AA	H	x	L	L	H	x	x	H	L
AC	H	L	L	M	L	x	x	H	L
AD	H	M	L	M	L	x	H	H	L
AE	H	H	L	H	x	x	M	H	L
BB	H	x	L	L	H	x	x	M	M
BC	H	L	L	M	M	x	x	M	M
BD	H	M	L	M	L	x	H	M	M
BE	H	H	L	H	x	x	M	M	M
CC	M	L	M	M	H	x	x	L	H
CC	M	M	M	M	M	x	H	L	H
CE	M	H	M	H	x	x	M	L	H
DC	L	L	H	M	M	H	x	L	H
DD	L	M	H	M	H	H	H	L	H
DE	L	H	H	H	x	H	M	L	H

H: High, M: Medium, L: Low, x: No effect

TABLE IV: Weighted* sum of the scores of the PV-ESS scenarios of table III with preference for high energy neutrality without storage

		PV Location			
		A	B	C	D
ESS Location	A	20			
	B		17		
	C	20	17	13	12
	D	20	17	13	12
	E	20	17	13	12

*weights: [3, 0, 2, 0, 0, 0, 3, 0, 0]

TABLE V: Weighted sum of the scores of the PV-ESS scenarios of table III with preference for the the sustainable, multi-functional trolleygrid (smart grid technologies integration)

		PV Location			
		A	B	C	D
ESS Location	A	19			
	B		20		
	C	19	21	21	27
	D	29	30	30	38
	E	27	28	27	34

*weights: [3, 1, 1, 1, 3, 3, 1, 2, 1]

about 10 times as much as a 300kW opportunity charger [18]. Additionally, an electric bus can be about 10% higher in operational costs. Furthermore, the lack of battery data and understanding of battery ageing and behavior leaves the trolleybus operators overestimating the costs in their tenders as a financial risk management strategy. Recent examples of unforeseen and inexplicable battery behavioral problems are the electric buses breaking down in Berlin and Trier in cold conditions, while those in Scandinavian countries have been operating normally in harsh winter conditions [65, 66].

Data sharing between international transport network operators should be facilitated by international bodies, and explicitly incentivized in tendering documents to allow operators and researchers a faster understanding of battery ageing and operational lessons learnt.

Funding should also be made more available for sustainable electrification projects. In Europe, the predominant long-term funding bodies are the European Investment Bank (EIB) and local banks, as well as EU research agendas (e.g. ELIPTIC, EfficienCE, ASSURED, Trolley2.0, H2ME). On the other hand, the yearly operations are funded by local and national sources (e.g. Barcelona, Budapest) or federal funding (USA), but in both cases limited in resources and project-specific. Otherwise, tax and subsidies are offered as is the case in China (with its city of Shenzhen operating the world’s largest electric bus fleet) and India [45, 65, 67–70].

Finally, it is worth noting that there is a general hostility from the public toward catenary systems. The infrastructure is seen as unattractive and intrusive, although some work is being actively pursued in changing this public opinion [18, 19]. This again makes the case for IMC systems as they can retain the benefits of a trolleygrid with minimal catenary lengths.

B. The Diesel Mentality

Another non-technical challenge is the Diesel-oriented point of view of the stakeholders; a concept that can be suitably referred to as the "Diesel Mentality".

If the electrification of diesel buses is seen as a mere replacement of the bus traction energy source, the potential of the possibilities an active, smart grid backbone to the local grid as discussed in the introduction of this paper would be lost. In other terms, there should not be a reductive view of the

transport network as a mono-functional grid inherited from diesel networks.

Beyond missing out on the synergetic potential of these electrified networks and their active role, two dangerous consequences of the diesel mentality are already observable in the contracting and organization of the tenders for the buses and charging infrastructures and of daily bus operations.

The first problem is a lack of a centralized body and approach to tendering and contracting. This is the most problematic in locations where the fleet ownership and maintenance is privately owned (e.g., the UK and The Netherlands). In these locations, a strong coordination and harmonization is needed among the tenders to avoid a heterogeneous charging infrastructure throughout the city that can cause problems to both future bus operating companies and the operation of the electric network. [46] The city of Munich, for example, tendered the charging infrastructure and the buses separately. An interesting example is from Hamburg where the electric network provider is a partner in managing the transport network, to better integrate the electricity demand in the city demand and share the operational expertise. [45, 46].

These sort of models are the most important for the integration of RES and storage in the future transport grids as not all stakeholders can handle alone the technical expertise and financial costs of running such complex systems [18, 45]. The local authority should take over or at least delegate the division of roles and be more involved in the (faster) licensing and permit processes. It is also important as the lifetime of the charging infrastructure (15+ years) does not match that of the typical bus operating tenders (4-10 years) or that of the batteries (6-8 years). This leaves a lot of uncertainties and risks for the involved parties while preparing tenders [45, 46]. The other problem is the legal barrier to trolleygrid operators to sell their (subsidized) energy to third parties. This creates the major hurdle for the integration of EV chargers for private car charging. While the solution is as simple as a net metering of the demand of the trolleygrid, the contractual limitation needs to be addressed in future tenders before EV chargers can be implemented. An example to highlight is the trolleygrid of Arnhem, The Netherlands, where EV chargers are used to charge the battery mini-buses of the transportation company itself [26, 28].

C. The Impracticality of Pilot Projects

Finally, it is worth acknowledging the difficulty of implementing pilot projects on a public transportation service as that could severely disrupt operations, especially when the DSO/TSO are not involved. This is again why the Hamburg model, where the electric network provider is included in the process, is interesting.

In the face of limited pilots, bus operators and stakeholders should be urged and incentivized to intensify their cooperation with researchers and academic institutions who have the skills to conduct in-depth and accurate theoretical studies.

VII. CONCLUSIONS

In conclusion, the sustainable, multi-functional urban bus grid of the future faces many technical and non-technical problem. The feasible vision of this grid is a catenary grid running IMC trolleybuses, with integrated PV, EV chargers, and stationary storage systems. Their operation should involve an array of partners from key operational stakeholders to the DSO/TSO and research/academic institutions to share both the operational expertise as well as the financial loads, while being guided and connected via a coordinating body. Transport system stakeholders are urged to open up to the possibilities of an active, multi-functional smart transport grid that can act as a backbone to the city grid, and reduce all legal and financial hurdles facing it.

REFERENCES

- [1] European Commission, "Together towards competitive and resource-efficient urban mobility," 2013.
- [2] C. Wang, W. Cai, X. Lu, and J. Chen, "Co2 mitigation scenarios in china's road transport sector," *Energy Conversion and Management*, vol. 48, no. 7, pp. 2110–2118, 2007.
- [3] G. B. Alliance, "A vision for a sustainable battery value chain in 2030: Unlocking the full potential to power sustainable development and climate change mitigation," in *Geneva, Switzerland: World Economic Forum*, 2019.
- [4] H. Fitzová and M. Matulová, "Comparison of urban public transport systems in the czech republic and slovakia: Factors underpinning efficiency," *Research in Transportation Economics*, vol. 81, p. 100824, 2020.
- [5] I. Diab, A. Saffirio, G. R. C. Mouli, A. S. Tomar, and P. Bauer, "A complete dc trolleybus grid model with bilateral connections, feeder cables, and bus auxiliaries," *IEEE Transactions on Intelligent Transportation Systems*, pp. 1–12, 2022.
- [6] A. Kołoś and J. Taczanowski, "The feasibility of introducing light rail systems in medium-sized towns in central europe," *Journal of Transport Geography*, vol. 54, pp. 400–413, 2016.
- [7] L. Borowik and A. Cywiński, "Modernization of a trolleybus line system in tychy as an example of eco-efficient initiative towards a sustainable transport system," *Journal of Cleaner Production*, vol. 117, pp. 188–198, 2016.
- [8] M. Wołek, M. Wolański, M. Bartłomiejczyk, O. Wyszomirski, K. Grzelec, and K. Hebel, "Ensuring sustainable development of urban public transport: A case study of the trolleybus system in gdynia and sopot (poland)," *Journal of Cleaner Production*, vol. 279, p. 123807, 2021.
- [9] L. Brunton, "The trolleybus story," *IEE Review*, vol. 38, no. 2, pp. 57–61, 1992.
- [10] M. Bartłomiejczyk, "Smart grid technologies in electric power supply systems of public transport," *Transport*, vol. 33, no. 5, pp. 1144–1154, 2018.
- [11] I. Diab, B. Scheurwater, A. Saffirio, G. R. Chandramouli, and P. Bauer, "Placement and sizing of solar pv

- and wind systems in trolleybus grids,” *Journal of Cleaner Production*, p. 131533, 2022.
- [12] M. Bartłomiejczyk, “Potential application of solar energy systems for electrified urban transportation systems,” *Energies*, vol. 11, no. 4, p. 954, 2018.
- [13] S. Kratz, A. Schmidt, B. Krueger, R. Wegener, and S. Soter, “Power supply of a short-range public transportation system based on photovoltaics-potential analysis and implementation,” in *2019 IEEE 46th Photovoltaic Specialists Conference (PVSC)*. IEEE, 2019, pp. 3077–3081.
- [14] S. Kratz, B. Krueger, R. Wegener, and S. Soter, “Integration of photovoltaics into a smart trolley system based on sic-technology,” in *2018 IEEE 7th International Conference on Power and Energy (PECon)*. IEEE, 2018, pp. 168–173.
- [15] M. Salih, D. Baumeister, M. Wazifehdust, P. Steinbusch, M. Zdrallek, P. Deskovic, T. Küll, and C. Troullier, “Impact assessment of integrating novel battery-trolleybuses, pv units and ev charging stations in a dc trolleybus network,” in *In 2nd E-Mobility Power System Integration Symposium*. MOSI Symposium, 2018, pp. 1–6.
- [16] M. Salih, D. Baumeister, M. Wazifehdust, P. Steinbusch, M. Zdrallek, S. Mour, P. Deskovic, T. Küll, and C. Troullier, “Optimized positioning for storage systems in an lvdc traction grid with non-receptive power sources and photovoltaic systems,” Unpublished, 2018.
- [17] M. Wazifehdust, D. Baumeister, M. Salih, P. Steinbusch, M. Zdrallek, S. Mour, and C. Troullier, “Potential analysis for the integration of renewables and ev charging stations within a novel lvdc smart-trolleybus grid,” 2019.
- [18] M. Bartłomiejczyk, *Dynamic Charging of Electric Buses*. Gdańsk University of Technology, Faculty of Electrical and Control Engineering, 2018. [Online]. Available: https://books.google.cz/books?id=ziX_vQEACAAJ
- [19] M. Wolek, M. Wolański, M. Bartłomiejczyk, O. Wyszomirski, K. Grzelec, and K. Hebel, “Ensuring sustainable development of urban public transport: A case study of the trolleybus system in gdynia and sopot (poland),” *Journal of Cleaner Production*, vol. 279, p. 123807, 2021.
- [20] W. Vermeer, G. R. Chandra Mouli, and P. Bauer, “A multi-objective design approach for pv-battery assisted fast charging stations based on real data,” in *2022 IEEE Transportation Electrification Conference Expo (ITEC)*, 2022, pp. 114–118.
- [21] A. Rufer, D. Hotellier, and P. Barrade, “A supercapacitor-based energy storage substation for voltage compensation in weak transportation networks,” *IEEE Transactions on power delivery*, vol. 19, no. 2, pp. 629–636, 2004.
- [22] D. Zhang, J. Jiang, W. Zhang *et al.*, “Robust and scalable management of power networks in dual-source trolleybus systems: A consensus control framework,” *IEEE transactions on intelligent transportation systems*, vol. 17, no. 4, pp. 1029–1038, 2015.
- [23] D. Iannuzzi, D. Lauria, and P. Tricoli, “Optimal design of stationary supercapacitors storage devices for light electrical transportation systems,” *Optimization and Engineering*, vol. 13, no. 4, pp. 689–704, 2012.
- [24] D. Zhang, J. Jiang, W. Zhang *et al.*, “Optimal power management in dc microgrids with applications to dual-source trolleybus systems,” *IEEE Transactions on Intelligent Transportation Systems*, vol. 19, no. 4, pp. 1188–1197, 2017.
- [25] R. F. Paternost, R. Mandrioli, R. Barbone, V. Cirimele, J. Loncarski, and M. Ricco, “Impact of a stationary energy storage system in a dc trolleybus network,” in *2022 IEEE Transportation Electrification Conference & Expo (ITEC)*. IEEE, 2022, pp. 1211–1216.
- [26] I. Diab, G. R. Chandra Mouli, and P. Bauer, “Increasing the integration potential of ev chargers in dc trolley-grids: A bilateral substation-voltage tuning approach,” in *2022 IEEE International Symposium on Power Electronics, Electrical Drives and Automation and Motion (SPEEDAM)*, 2022, pp. 1–6.
- [27] M. Bartłomiejczyk, L. Jarzebowicz, and R. Hrbáč, “Application of traction supply system for charging electric cars,” *Energies*, vol. 15, no. 4, p. 1448, 2022.
- [28] A. Shekhar, G. C. R. Mouli, S. Bandyopadhyay, and P. Bauer, “Electric vehicle charging with multi-port converter based integration in dc trolley-bus network,” in *2021 IEEE 19th International Power Electronics and Motion Control Conference (PEMC)*. IEEE, 2021, pp. 250–255.
- [29] M. Bartłomiejczyk, “Practical application of in motion charging: Trolleybuses service on bus lines,” in *2017 18th International Scientific Conference on Electric Power Engineering (EPE)*. IEEE, 2017, pp. 1–6.
- [30] I. Diab, G. R. Chandra Mouli, and P. Bauer, “Toward a better estimation of the charging corridor length of in-motion-charging trolleybuses,” in *2022 IEEE Transportation Electrification Conference & Expo (ITEC)*, 2022, pp. 557–562.
- [31] A. S. Tomar, B. Veenhuizen, L. Buning, and B. Pyman, “Estimation of the size of the battery for hybrid electric trolley busses using backward quasi-static modelling,” in *Multidisciplinary Digital Publishing Institute Proceedings*, vol. 2, no. 23, 2018, p. 1499.
- [32] E. Sindi, M. Polis, G. Yin, L. Ding *et al.*, “Distributed optimal power and voltage management in dc microgrids: Applications to dual-source trolleybus systems,” *IEEE transactions on transportation electrification*, vol. 4, no. 3, pp. 778–788, 2018.
- [33] D. Zhang, J. Jiang, W. Zhang *et al.*, “Load prediction and distributed optimal control of on-board battery systems for dual-source trolleybuses,” *IEEE Transactions on Transportation Electrification*, vol. 3, no. 1, pp. 284–296, 2016.
- [34] M. Bartłomiejczyk, “Practical application of in motion charging: Trolleybuses service on bus lines,” in *2017 18th International Scientific Conference on Electric Power Engineering (EPE)*. IEEE, 2017, pp. 1–6.

- [35] Kiepe Electric, “Articulated Electric Bus with In Motion Charging (IMC) Geneva, Switzerland.” [Online]. Available: https://platformduurzaamovenspoor.nl/publish/pages/126672/factsheet_geneva_articulated_imc_electric_bus_823_e.pdf
- [36] Kiepe Electric, “Double-articulated electric bus with in motion charging linz, austria.” [Online]. Available: https://www.kiepe.knorr-bremse.com/electric-buses/trolleybuses/references/vkprodukt.2018-04-05.5965687810/vkprodukt_download
- [37] M. Wołek, A. Szmelter-Jarosz, M. Koniak, and Golejewska, “Transformation of trolleybus transport in poland. does in-motion charging matter?” 2020.
- [38] F. Bergk, K. Biemann, U. Lambrecht, D. Prof, and R. Pütz, “Potential of In-Motion Charging Buses for the Electrification of Urban Bus Lines,” *Journal of Earth Sciences and Geotechnical Engineering*, vol. 6, no. 4, pp. 347–362, 2016.
- [39] ASSURED Project, “Standardisation of e-bus charging: Overview & project activities,” 2020. [Online]. Available: https://assured-project.eu/storage/files/2-asr-interop-workshop-standardisation-activities-peter-cremers_1.pdf
- [40] A. de Pee, H. Engel, M. Guldmond, A. Keizer, and J. van de Staaij, “The European Electric Bus Market Is Charging Ahead but How Will it Develop?” 2022. [Online]. Available: <https://www.mckinsey.com/industries/oil-and-gas/our-insights/the-european-electric-bus-market-is-charging-ahead-but-how-will-it-develop>
- [41] Fuel Cell Busses, “About Fuel Cell Electric Buses,” 2022. [Online]. Available: <https://fuelcellbuses.eu/wiki/fuel-cell-electric-buses-fuel-cell-electric-buses/about-fuel-cell-electric-buses>
- [42] UITP, “About Fuel Cell Electric Buses,” 2020.
- [43] C. Leone, M. Longo, L. Corradini, M. Monti, D. Zaninelli, and L. M. Fernández-Ramírez, “Charging infrastructure sizing for the electrification of a bus line,” in *2021 AEIT International Conference on Electrical and Electronic Technologies for Automotive (AEIT AUTOMOTIVE)*. IEEE, 2021, pp. 1–6.
- [44] M. F. Far, M. Paakinen, and P. Cremers, “A framework for charging standardisation of electric buses in europe,” in *2020 IEEE Vehicle Power and Propulsion Conference (VPPC)*. IEEE, 2020, pp. 1–4.
- [45] UITP, “Large Scale Bus Electrification: The Impact on Business Models,” <https://cms.uitp.org/wp/wp-content/uploads/2021/07/Large-scale-Bus-Electrification-KB-Final.pdf>, July 2021, (Accessed on 06/02/2022).
- [46] A. L. Rodrigues and S. R. Seixas, “Battery electric buses and their implementation barriers: Analysis and prospects for sustainability,” *Sustainable Energy Technologies and Assessments*, vol. 51, p. 101896, 2022.
- [47] R. A. Alarrouqi, S. Bayhan, and L. Al-Fagih, “Battery electric buses operating in qatar: A comprehensive energy consumption analysis,” in *2022 IEEE Transportation Electrification Conference & Expo (ITEC)*. IEEE, 2022, pp. 1236–1241.
- [48] A. S. Tomar, B. Veenhuizen, L. Buning, and B. Pyman, “Estimation of the size of the battery for hybrid electric trolley busses using backward quasi-static modelling,” *Proceedings*, vol. 2, no. 23, 2018.
- [49] B. Destraz, P. Barrade, A. Rufer, and M. Klohr, “Study and simulation of the energy balance of an urban transportation network,” in *2007 European conference on power electronics and applications*. IEEE, 2007, pp. 1–10.
- [50] M. Bartłomiejczyk and M. Połom, “Multiaspect measurement analysis of breaking energy recovery,” *Energy conversion and management*, vol. 127, no. 1, pp. 35–42, 2016.
- [51] A. Finlayson, C. Goodman, and R. White, “Investigation into the computational techniques of power system modelling for a dc railway,” 2006.
- [52] D. Iannuzzi, F. Ciccarelli, and D. Lauria, “Stationary ultracapacitors storage device for improving energy saving and voltage profile of light transportation networks,” *Transportation Research Part C: Emerging Technologies*, vol. 21, no. 1, pp. 321–337, 2012.
- [53] M. Z. Chymera, A. C. Renfrew, M. Barnes, and J. Holden, “Modeling electrified transit systems,” *IEEE Transactions on Vehicular Technology*, vol. 59, no. 6, pp. 2748–2756, 2010.
- [54] B.-Y. Ku and J.-S. Liu, “Solution of dc power flow for nongrounded traction systems using chain-rule reduction of ladder circuit jacobian matrices,” in *ASME/IEEE Joint Railroad Conference*. IEEE, 2002, pp. 123–130.
- [55] D. Iannuzzi and P. Tricoli, “Speed-based state-of-charge tracking control for metro trains with onboard supercapacitors,” *IEEE Transactions on Power Electronics*, vol. 27, no. 4, pp. 2129–2140, 2011.
- [56] G. Stana and V. Brāzis, “Trolleybus motion simulation by dealing with overhead DC network energy transmission losses,” in *2017 18th International Scientific Conference on Electric Power Engineering (EPE)*. IEEE, 2017, pp. 1–6.
- [57] Š. Hamacek, M. Bartłomiejczyk, R. Hrbáč, S. Mišák, and V. Stýskala, “Energy recovery effectiveness in trolleybus transport,” *Electric Power Systems Research*, vol. 112, pp. 1–11, 2014.
- [58] G. Stana and V. Brāzis, “Mathematical Calculation of Power Transmission Related Parameters in Simulations of Overhead Grid-Connected Electric Public Transport Motion,” in *2020 IEEE 61th International Scientific Conference on Power and Electrical Engineering of Riga Technical University (RTUCON)*. IEEE, 2020, pp. 1–6.
- [59] —, “Trolleybus with ESS motion simulation considering common mass increase and transmission losses,” in *2017 IEEE 58th International Scientific Conference on Power and Electrical Engineering of Riga Technical University (RTUCON)*. IEEE, 2017, pp. 1–6.

- [60] D. Baumeister, M. Salih, M. Wazifehdust, P. Steinbusch, M. Zdrallek, S. Mour, L. Lenuweit, P. Deskovic, and H. B. Zid, “Modelling and simulation of a public transport system with battery-trolleybuses for an efficient e-mobility integration,” in *1st E-Mobility Power System Integration Symposium*, 2017.
- [61] P. Arboleya, B. Mohamed, and I. El-Sayed, “Dc railway simulation including controllable power electronic and energy storage devices,” *IEEE Transactions on Power Systems*, vol. 33, no. 5, pp. 5319–5329, 2018.
- [62] M. Bartłomiejczyk, “Bilateral power supply of the traction network as a first stage of smart grid technology implementation in electric traction,” in *MATEC Web of Conferences. Vol. 180*. EDP Sciences, 2018, pp. 1–6.
- [63] —, “Modern technologies in energy demand reducing of public transport—practical applications,” in *2017 Zooming Innovation in Consumer Electronics International Conference (ZINC)*. IEEE, 2017, pp. 64–69.
- [64] —, “Use of numerical methods in the analysis of traction energy systems—an overview of the practical examples,” in *Proceedings of the First International Scientific Conference “Intelligent Information Technologies for Industry”(IITI’16)*. Springer, 2016, pp. 407–418.
- [65] M. Pagliaro and F. Meneguzzo, “Electric bus: a critical overview on the dawn of its widespread uptake,” *Advanced Sustainable Systems*, vol. 3, no. 6, p. 1800151, 2019.
- [66] Green Zones EU, “E-buses fail in the cold – green-zones.eu,” <https://www.green-zones.eu/en/blog-news/e-buses-fail-in-the-cold>, February 2021, (Accessed on 06/02/2022).
- [67] B. Freudenberg and T. Knotte, “Eberswalde final use case report,” 5 2015, elliptic Project.
- [68] M. Bartłomiejczyk, A. Jagiello, M. Wolek, M. Woronowicz, and O. Wyszomirski, “Gdynia final use case report,” June 2018, elliptic Project.
- [69] A. Náday, I. Tibor Tóth, Z. Németh, and N. Újhelyi, “Szeged final use case report,” June 2018, elliptic Project.
- [70] A. Náday, I. T. Tóth, D. Z. Ádám Németh, and N. Újhelyi, “Szeged final use case report,” Elliptic Project, Tech. Rep., Jun. 2018. [Online]. Available: