

The impact of hydro generation on board large sailing yachts

van der Plas, M.D.; Hillege, L.; de Vos, P.

DOI

[10.59490/imdc.2024.906](https://doi.org/10.59490/imdc.2024.906)

Publication date

2024

Document Version

Final published version

Published in

Proceedings of the 15th International Marine Design Conference (IMDC-2024)

Citation (APA)

van der Plas, M. D., Hillege, L., & de Vos, P. (2024). The impact of hydro generation on board large sailing yachts. In *Proceedings of the 15th International Marine Design Conference (IMDC-2024)* (International Marine Design Conference). TU Delft OPEN Publishing. <https://doi.org/10.59490/imdc.2024.906>

Important note

To cite this publication, please use the final published version (if applicable). Please check the document version above.

Copyright

Other than for strictly personal use, it is not permitted to download, forward or distribute the text or part of it, without the consent of the author(s) and/or copyright holder(s), unless the work is under an open content license such as Creative Commons.

Takedown policy

Please contact us and provide details if you believe this document breaches copyrights. We will remove access to the work immediately and investigate your claim.

The impact of hydro generation on board large sailing yachts

Marijn van der Plas^{1,*}, Wick Hillege² and Peter de Vos³

ABSTRACT

In response to the leading narrative of increasing sustainability in the yachting sector, a research collaboration is started between the Delft University of Technology and Dykstra Naval Architects (DNA) to examine the potential use of hydro generation on board large sailing yachts. By harvesting energy from the water flow when a yacht is sailing, diesel generator use can be limited, reducing overall emissions. However, it is a challenge to quickly identify the impact of a chosen hydro generation system on the overall design during the early stages of yacht design. A design method, with a primary focus on the propeller, is therefore developed to quantify this impact. This allows the designer to explore various hydro generation systems in an early design stage. This paper describes the developed method and presents results from a case study to provide insight into the applicability of the method.

KEY WORDS

Hydro generation; Sailing; Ship design; Sustainability

INTRODUCTION

The yachting industry is growing, as is the idea of sustainable yachting. Sailing yachts can limit emissions from the yachting sector with their ability to transit without using fossil fuels. However, a modern sailing yacht does require electricity to run its hotel, navigation, and sailing systems during sailing. The main engine or a dedicated engine-generator set usually provides this electricity. Alternative solutions for this exist. This paper focuses on one of these alternatives: hydro generation.

Hydro generation is the process of extracting momentum from a water flow to generate electricity. On board a sailing yacht this is achieved using the propulsion propeller or a separate dedicated turbine. This concept is realized in, among others, sailing yachts Black Pearl, Perseverance, and Project Zero, the latter currently under construction at Vitters Shipyards. The implementation of hydro generation serves two purposes: economic and ecological improvement, i.e. installing a hydro generation system limits the use of fossil fuel onboard, decreases related costs, and limits fuel-related emissions. However, it does give rise to several challenges that need to be overcome. These challenges find their origin in the required balance between the inevitable increase in system weight and size relative to, for example, emission reduction.

Today's approach towards analyzing a hydro generation system is characterized by detailed propeller calculations combined with refined flow analysis to converge to the optimum configuration. This approach requires detailed knowledge about the

¹ Department of Maritime and Transport Technology, Delft University of Technology, Delft, Netherlands

² Dykstra Naval Architects, Amsterdam, Netherlands

³ Department of Maritime and Transport Technology, Delft University of Technology, Delft, Netherlands; ORCID: 0000-0002-5835-2450

* Corresponding Author: marijnvdpas@gmail.com

yacht's lines plan and chosen propulsion system making it unsuitable to use in the early stages of yacht design. The study presented here aims to overcome this difficulty by only utilizing first principles and main particulars. The method developed for this study allows the designer to efficiently investigate the impact of various configurations on the overall design, safeguarding the necessary flexibility.

The design method considers the impact of six major variables that influence hydro generation. The first three variables concern size and include the propeller diameter, battery capacity, and sail area. The remaining variables relate to operational and design choices and include decisions on energy consumption, fixed or controllable pitch propellers, and generation in the first or third quadrant of the propeller diagram. A case study for an ocean crossing with a sailing yacht aiming to limit fuel consumption demonstrates the influence of these design decisions. It shows that this method can support major design choices whilst having limited knowledge about the final design.

THEORY

Since this method is intended for an early-stage design assessment the calculations are very general. The energy balance is analyzed using only main dimensions and rough propeller data.

Turbine physics

A hydro turbine is designed to extract energy from a fluid flow and convert it to useful work. Since the turbine under consideration here is placed in an open flow, under a hull, the available power in the flow depends on the cross-sectional area, speed, and density of the fluid only:

$$P_{flow} = \frac{1}{2} \rho V_a^2 \cdot \dot{V} \quad (1)$$

$$P_{flow} = \frac{1}{2} \rho V_a^3 \cdot A_0 \quad (2)$$

Where in this case, ρ is the density of seawater, V_a is the advance velocity of the propeller, and A_0 is the propeller disc area. The efficiency of a turbine is often defined in literature by the fraction of the output of the turbine (in useful work) divided by the energy supplied to it; in case of a classical hydro turbine, this is the power present in the flow. For a turbine mounted on a moving object (the yacht), the energy supplied to it is not the power present in the flow, but rather the power required to move it through the water, so effectively, the drag of the unit multiplied by its speed through the water. The ratio between the power in the flow versus the output power is however significant property of the turbine, and is referred to as the power coefficient (C_p) in this paper, this in analogy to the power rating of wind turbines:

$$C_p = \frac{P_{extracted}}{P_{flow}} = \frac{P_{extracted}}{\frac{1}{2} \cdot \rho \cdot V_a^3 \cdot A_0} \quad (3)$$

$$P_{extracted} = C_p \cdot P_{flow} = C_p \cdot \frac{1}{2} \cdot \rho \cdot V_a^3 \cdot A_0 \quad (4)$$

The ratio between the useful power and the supplied power is, in analogy with common propeller theory, defined as the output power divided by the input power:

$$\eta_{regen} = \frac{P_{extracted}}{T \cdot V_a} = \frac{Q \cdot \omega}{T \cdot V_a} \quad (5)$$

Where T normally stands for thrust of the propeller, which in this case means the drag of the propeller in turbine mode as described above. Note that the extracted power here is defined at the propeller shaft, i.e. mechanical losses and conversion efficiencies are not incorporated in η_{regen} and C_p , as is depicted below.

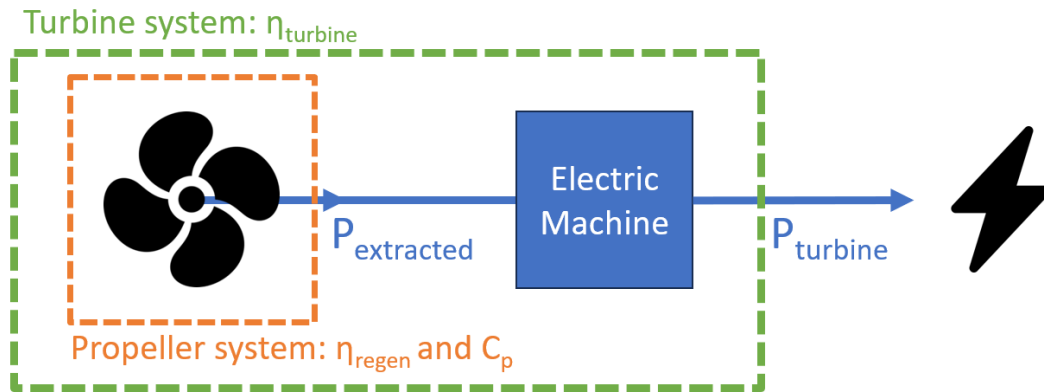

Figure 1: System definition for hydro generation systems

Turbines on sailing yachts

Every modern sailing yacht is fitted with a propeller for mechanical propulsion. With some adjustments and additions, this propeller can also function as a hydro generator. However, a propeller adds momentum to a flow, and a turbine is designed to extract the maximum energy from the available flow momentum. These are fundamentally different objectives combined with different physics. Propellers will generate a contracting flow and turbines an expanding flow. Furthermore, the flow around the blade is dissimilar for turbines and propellers. For propellers, lift is generated in the forward direction to deliver propulsion. For turbines, this lift is generated backwards resulting in drag. This is achieved by altering the angle of attack on the propeller blades. The main problem is the required shape. The shape differs for an optimal propeller from that of an optimal turbine. There are two adjustments that (partially) overcome this problem, either by adjusting the pitch of the blades, the flow direction, or both.

Fixed and controllable pitch propellers

Propellers can roughly be divided into two groups, fixed-pitch propellers (FPP) and controllable-pitch propellers (CPP). When considering an FPP, the pitch of the blades cannot be adjusted. The propeller is designed to work well in one operating point, likely a design point in propulsion. Outside this point, the propeller will not operate optimally and efficiency is compromised. Modern sailing yachts however operate at more than one operating point being propulsion, motor sailing, and free sailing. This requires a certain flexibility in different pitch settings. For this reason, the second propeller type, a CPP, is mostly applied on modern sailing yachts. Additional benefits of a CPP arise when considering hydro generation. During hydro generation, a sailing yacht is slowed down depending on the amount of energy extracted from the flow. Knowing this it can be reasoned that a CPP allows for more efficient hydro generation as the blade's pitch can be adjusted to meet the changing flow speed whilst tuning to the desired system energy output. This characteristic makes a CPP more suitable for hydro generation when compared to an FPP as it allows for better balancing the desired energy extracted with the desired sailing speed.

Generation quadrants

In this study the definition by Kuiper (1991) is adopted for the four propeller quadrants, it describes the transition between each quadrant as a function of the hydrodynamic pitch angle β . Several points of interest occur when increasing β for a fixed blade profile. In figure 2, points of interest on a fixed blade are shown:

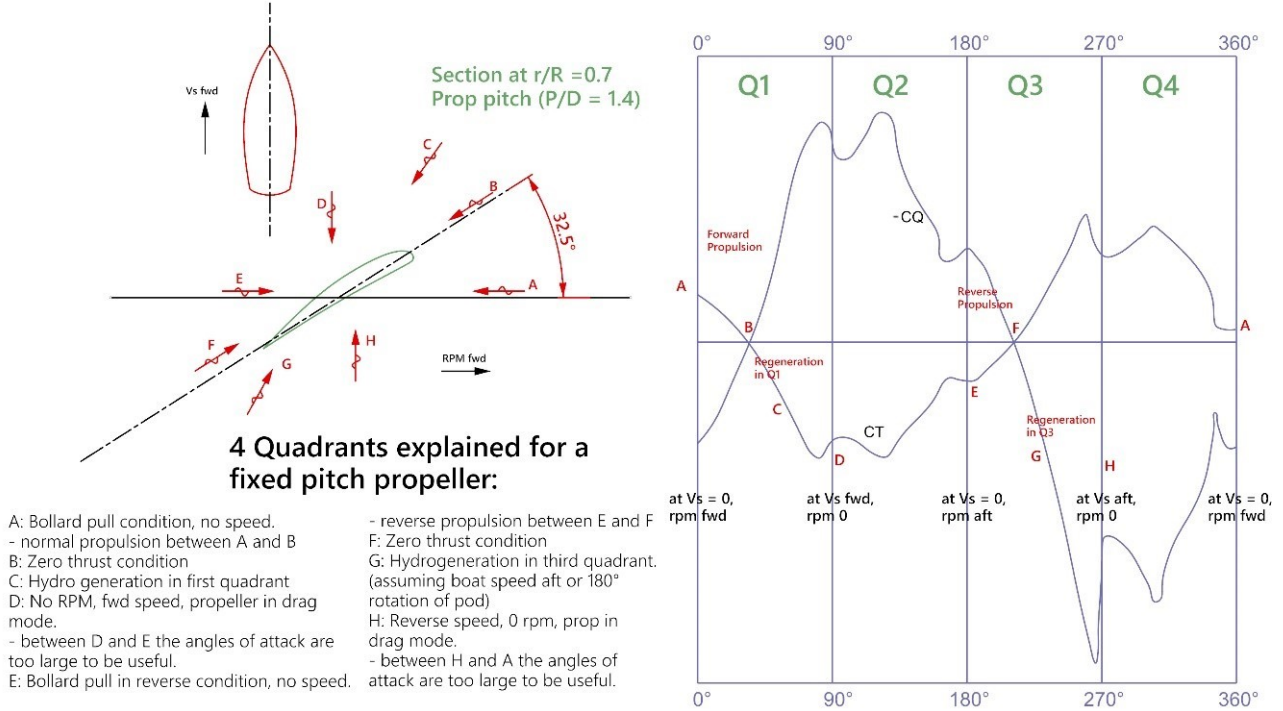

Figure 2: Four quadrants and the hydrodynamic pitch angles on a blade

FORCE BALANCE

During the simulations, the equations of motion are solved in 1 degree of freedom, x-direction only. For this, a force balance is defined for the conditions of motoring, free sailing, and for hydro generating. The latter is discussed in more detail below and shown mathematically in equation 6. The left-hand side of this equation represents the energy input in the system, driving force by the sails or propeller (not touched upon in this paper), whereas the right-hand side represents the energy output or loss.

When hydro generating, the total resistance comprises four parts: the hull resistance, the additional resistance due to side force, the resistance caused by the propeller blades ($R_{prop,generation}$), and the propeller related structure resistance ($R_{structure}$), equation 6.

$$F_{driving} = R_{hull} + R_{side} + R_{prop,generation} + R_{structure} \quad (6)$$

During the simulations the hull resistance and resistance due to side force are calculated adopting the relations developed

with the Delft Systematic Yacht Hull Series (DSYHS) as described by Keuning and Sonnenberg (1998). To determine the additional resistance due to hydro generation new formulations are derived. To better understand these formulations an understanding of feathered drag is necessary.

Feathered drag is the resistance of the propeller, in feathered condition, including surrounding structures. The presumption for this calculation is that the propeller blades are pitched into a setting where the least resistance occurs. Feathered drag is determined by multiplying a Prismatic Parameter (PiPa) with the pressure of water flow through the propeller area:

$$R_{feathered} = PiPa \cdot p_{flow} \quad [N] \quad (7)$$

$$= \left(\left(\frac{A_e}{A_0} \cdot A_0 \right) \cdot C_d \cdot \frac{A_p}{A_d} \right) \cdot \left(\frac{1}{2} \cdot \rho \cdot V_a^2 \right) \quad [N] \quad (8)$$

This formula encompasses all submerged propulsion system parts, such as hull bossing, shaft, struts, shaft brackets, and the propeller itself. The formula is based on the propeller area. It uses a coefficient C_d for the drag and a factor of $\frac{A_p}{A_d}$ to account for the difference between the developed area and the projected area of the propeller. Coefficient C_d for a feathered propeller is taken as 0.3 based on the findings of MacKenzie and Forrester (2008). The factor $\frac{A_p}{A_d}$ is based on formula 9 by Gerr (1989), adopting an average $\frac{P}{D}$ of 1.

$$\frac{A_p}{A_d} = 1.0125 - \left(0.1 \cdot \frac{P}{D} \right) - \left(0.0625 \cdot \frac{P}{D} \right)^2 \quad [-] \quad (9)$$

To determine the total resistance during generation a distinction between drag caused by the structure and drag caused by the propeller is necessary as propeller drag varies with the propeller setting. It can be shown that roughly 50% of the total feathered resistance can be attributed to the structure, equation 10. Further research in this area is recommended to refine this ratio.

$$R_{structure} \approx \frac{1}{2} R_{feathered} \quad (10)$$

The remaining resistance contribution is the resistance caused by the propeller blades during generation. For this, propeller curves in the first and third quadrant are constructed based on the chosen propeller geometry. To construct the propeller curves the polynomials describing the B4-70 propeller family are used as published by MARIN, van Lammeren et al. (1969). The outcome presents itself in K_t and K_q values for different hydrodynamic pitch (β) angles and $\frac{P}{D}$ values. Matching the K_t value to the selected propeller setting allows for calculating the propeller blade drag.

The force balance described above is used to determine the possible output of a specific hydro generation setup for various environmental conditions. For this, a performance prediction program is developed of which results are shown in figure 3.

Figure 3 indicates in white the conditions when there is not enough or too much wind. It is for these wind angles and wind speeds that the yacht will not sail and her main engine(s) are used to provide the necessary driving force to allow travel at transit speed. Transit speed is the desired minimum speed at which a yacht can perform a transit, this speed is based on the yacht's length. The grey area in the graph represents a free sailing condition, i.e. when the desired transit speed can be reached under sail power alone and the engines are turned off. However, hydro generation does not occur yet, as this would result in the transit speed dropping below a preset limit. The colored part of the graph represents the hydro generation condition where the limit of the transit speed is surpassed under sail power alone. The excess energy can now be harvested through hydro generation.

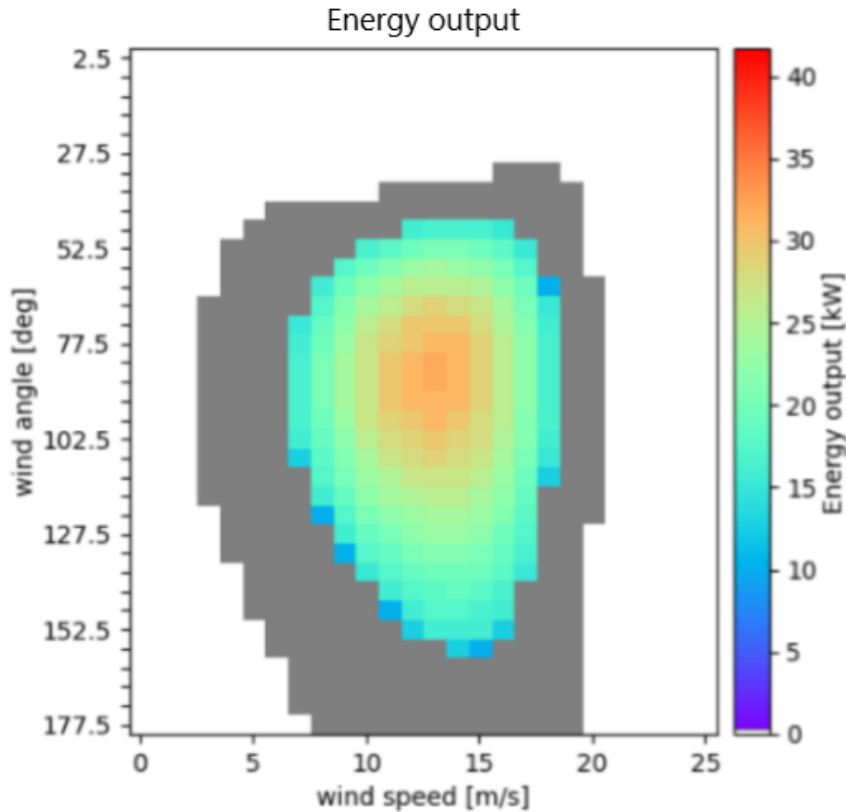

Figure 3: System energy output for the first quadrant

Hotel Load

The yacht's energy demand, or hotel load, is calculated adopting the method developed by Van Eesteren Barros and YETI van Eesteren Barros (2022). The yacht's operational profile is hereby taken into account. Following on board measurements and interviews with captains and crews, the values calculated via the YETI approach were deemed to be high, especially for sailing yachts. To better match the on board measured values a multiplication factor as a function of the yacht's waterline length is determined. For this a second-degree polynomial was drawn through the available data, resulting in a multiplication factor of roughly 0.42.

CASE STUDY

The goal is to perform a fuel-minimizing ocean passage. This means that the hotel load, modeled as a constant average, is compensated by utilizing hydro generation during the crossing where possible. A common ocean crossing for many big-class yachts is from the Mediterranean to the Caribbean once the European summer has ended. In this scenario, the sailing yacht leaves Gibraltar with a full battery and sets sail for the West Indies. The yacht's battery life is monitored for multiple crossings adopting a prediction for the chance of motoring, free sailing, and hydro generation. A crossing is considered a success if the crossing is completed without additional use of the diesel generator to supply the hotel load. A success rate is determined by dividing the number of successful crossings by the absolute number of crossings. For this case study five energy management rules are set to which the yacht adheres during each crossing.

- The engine covers the hotel load if turned on. The battery is not charged in this situation.
- The engine is used if the yacht cannot reach 80% transit speed using sails only.
- If 120% transit speed is reached under sail power alone, hydro generation is initiated. Transit speed is derived using the yacht's waterline length (l_{wl}) in meters, and relations shown in equation 11.
- Energy is supplied via the main engine, generators, and hydro generation only.
- A diesel generator supplies the hotel load if the battery state of charge reaches zero, and hydro generation is not possible.

$$F_n = \frac{V_{transit}}{\sqrt{g \cdot l_{wl}}} [-] \quad \text{in which:} \quad F_n = 0.3 - 0.1 \cdot \left(\frac{l_{wl}}{150m} \right) [-] \quad (11)$$

Typically, a crossing would be planned based on the weather, resulting in the best route. In this case study the crossing starts at fixed time intervals, regardless of the weather. Also, the great circle route is sailed, even if a longer distance passage would be faster. Predicting the wind that a vessel might encounter on this route is done through a weather mapping calculation developed by DNA. This weather mapping calculation determines a probabilistic distribution of prevailing wind speed and direction along that particular route based on historical weather data. To create the distribution used for this study the crossing is completed 190 times in a straight line at transit speed. The crossing is executed between October and November, the usual time for a crossing like this. A crossing is completed every ten days using wind data from 1979 to 2009. All data is summarized in a wind probability matrix with wind speed and wind direction on its axis.

Event distribution

The information displayed in figure 3 shows the energy output for various wind direction and speed combinations. It also shows the conditions for which, motoring, free-sailing, and hydro generation occur. By multiplying this data with the wind probability matrix a probability distribution for motoring (A), free-sailing (B), and hydro generation (C) can be calculated. For this case the event distribution equals roughly, 30% motoring, 50% free sailing, and 20% hydro generating, 5. Each event is considered independent.

Adopting the chances for an event to occur, a route is simulated using a randomizing function. A route is characterized by a series of events where a new event occurs every three hours of the crossing. In other words, one time step lasts three hours. The battery state of charge is monitored over the entire crossing.

The success of one crossing does not guarantee future crossings to be successful as well, due to the underlying probability distribution. In other words, for the case of one crossing the sample does not represent the population. By simulating multiple crossings and monitoring their results, an overall success rate is determined that is representative of the population's success rate. For a population-representative sample, the distribution of the events is to be representative to the original distribution. Within such a sample, there might be crossings where almost the entire distance could be sailed, and there might be crossings with no sailing at all. An additional benefit of completing multiple crossings is the elimination of the dependency on how the events follow one another. To check whether the sample created is representative for the population a control mechanism is modeled that verifies if the acquired distribution of events, figure 5, adequately represents the input distribution. If not more crossings are calculated to extend the sample.

For each unsuccessful crossing, the number of hours a backup diesel generator was run is calculated and stored. A distribution of the sample is formed for the sum of backup generator hours per crossing. Figure 4 is an example of such a distribution. The distribution represents 100,000 crossings of the Atlantic with a notional sailing yacht using the calculated event distribution (30-50-20) in 300 hours. Note that the event distribution is design-specific. This sailing yacht has a hotel load

of 15 kW, an average hydro generation capacity of 30 kW, and a 700 kWh battery. The total success rate for a generator-less crossing is 1.51%. On average the diesel generator is running for 94 hours.

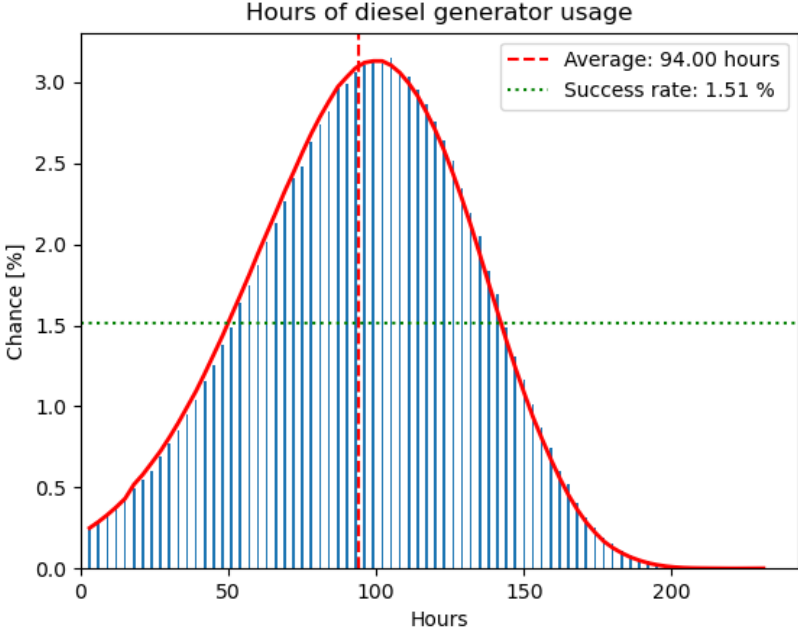

Figure 4: Sample distribution of generator hours, $n = 100.000$

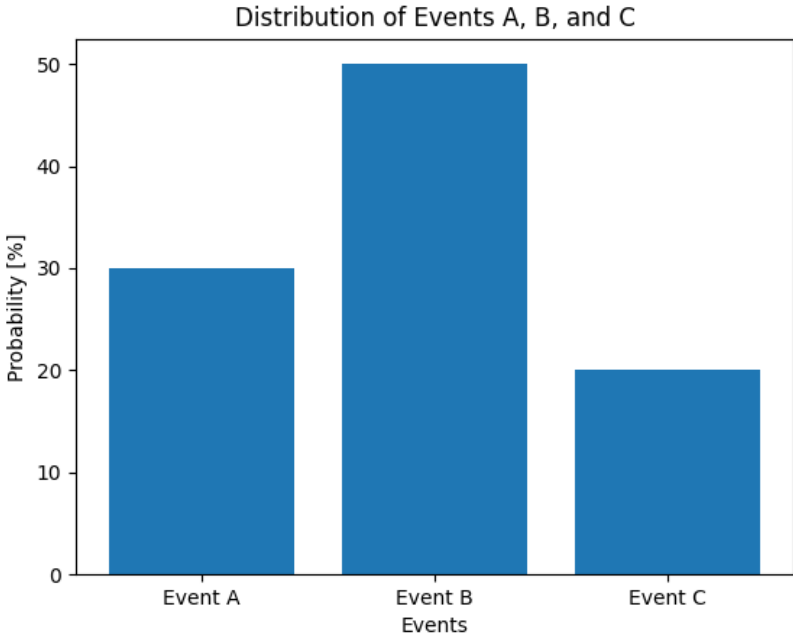

Figure 5: Sample event probability distribution, $n = 100.000$

Baseline

A 31-meter sailing yacht is set as a baseline for this case study. She is equipped with a shaft line mounted CPP that hydro generates in the first quadrant. The CPP allows four settings: feathering, maximizing η_{regen} , middle, and maximizing C_p . The design is characterized by a battery size of 200 kWh and a propeller with a diameter of 0.9 meters. The yacht runs an average hotel load of 26.2 kW. All simulations are done for $1 \cdot 10^6$ crossings.

The combined results of the crossings are shown for generator usage in figure 6. The success rate of this example is 0%, which indicates that the current design is under no conditions able to cross the ocean without running the diesel generator. On average, the diesel generator runs for about 232 hours during a crossing. From this baseline, design changes are introduced to the propeller, battery, and other factors such as the hotel load. In the following section, the impact of various changes on the expected average diesel generator running hours is shown.

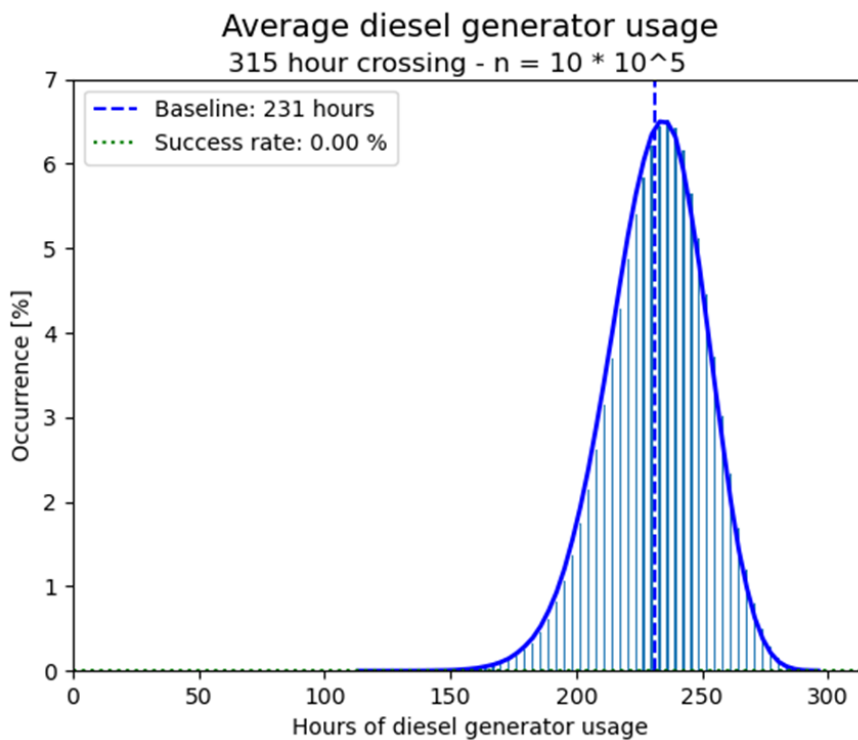

Figure 6: Baseline diesel generator usage

RESULTS

Several design changes are introduced to the baseline. These are a propeller diameter increase of 10%, a battery capacity increase of 100%, and a hotel load decrease of 30%. One variable is changed at a time in the baseline design after which its impact on average diesel generator usage is discussed. The reason for choosing above mentioned design alterations is that they do not require extensive changes to a yacht's design allowing for easy retrofitting if desired.

Propeller variation

The baseline's propeller measures at 0.9 meters which is increased to 0.99 meters. A larger change is deemed unrealistic without significant design changes. A larger propeller will result in more power output at the cost of additional resistance. This relationship is shown in figure 7. The impact on generator running hours is calculated and it is shown that increasing propeller size with 10% will lead to a decrease in diesel generator running hours of 5 hours. The chance for a successful crossing is not changed and remains 0%.

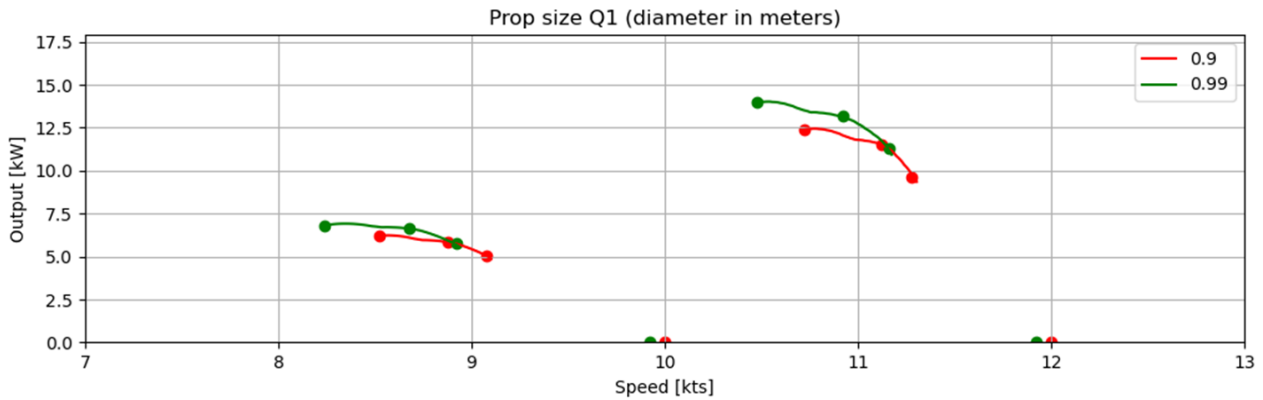

Figure 7: The effect of 10% increase in propeller diameter variation on the delivered power output.

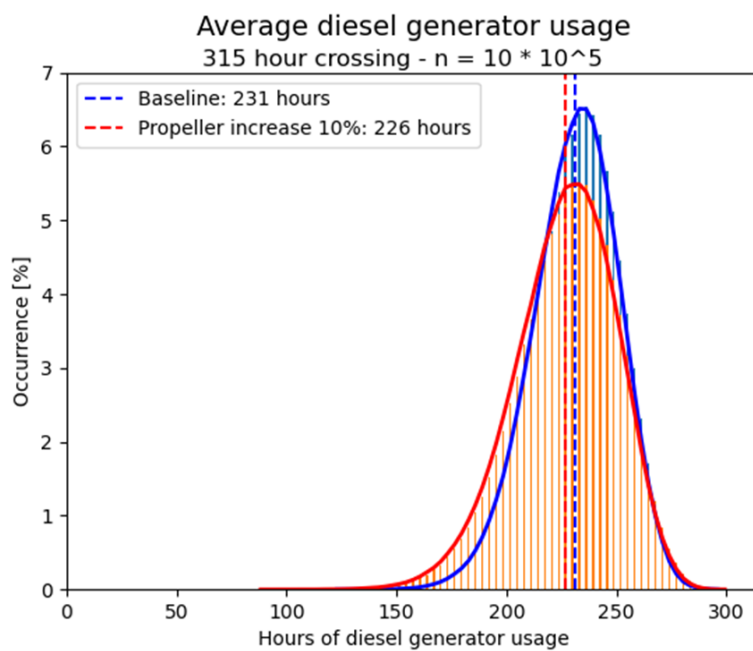

Figure 8: The effect of 10% increase in propeller diameter on average generator running hours.

Battery variation

Increasing the battery size by 100% leads to an increase in light ship weight of about 2%, based on phosphate batteries adopting a weight density of $0.133 \frac{kWh}{kg}$, Verma and Kumar (2021). During the early design stage such a weight increase is considered within reason to implement. Calculations show that increasing the battery size will lead to a 21-hour decrease in average diesel generator usage, shown in figure 9. The chance for a successful crossing is not changed and remains 0%.

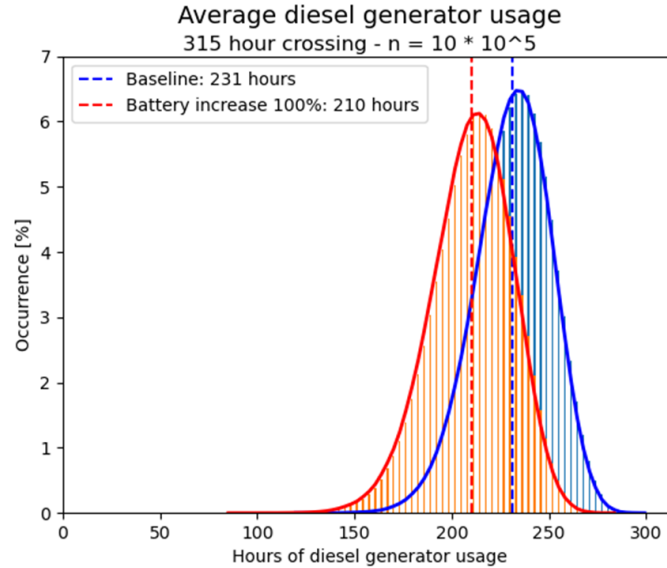

Figure 9: The effect of 100% increase in battery size on average diesel generator usage.

Hotel load variation

The final change deemed reasonable within the yacht's design without any significant design changes is a decrease in the hotel load. This can be achieved by incorporating more efficient systems together with better insulation. For the current design, a 30% decrease in average hotel load is considered feasible. A decrease of 30% of the hotel load reduces the generator hours from the baseline to 208 hours, indicating a 23-hour decrease, roughly equal to doubling the battery size. The chance for a successful crossing is not changed and remains 0%.

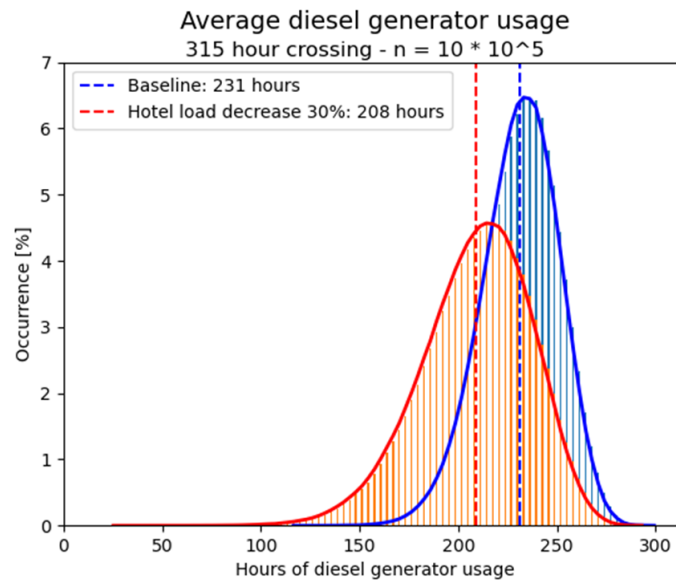

Figure 10: The effect of decreasing average hotel load with 30% on average diesel generator running hours.

Combined

The effect of combining above mentioned design alterations, i.e. implementing all at once, is also studied. It was found that changing the three variables at the same time shows a decrease in generator usage of 41%, as plotted in figure 11. A chance that the crossing succeeds is recorded at 0.02%, indicating that a crossing without any fuel consumption is possible, but not very probable. When compared to the other individual solutions it is found the combination of design alterations leads to a greater reduction in diesel generator hour usage than the sum of its parts, table 1.

Table 1: The effect of design alterations on average diesel generator usage.

	Baseline	Propeller	Battery Capacity	Hotel Load	Combined
Average generator running hours	231	226	210	208	139
Success Rate	0%	0%	0%	0%	0.02%
Diesel generator hours w.r.t Baseline	0	-5	-21	-23	-92

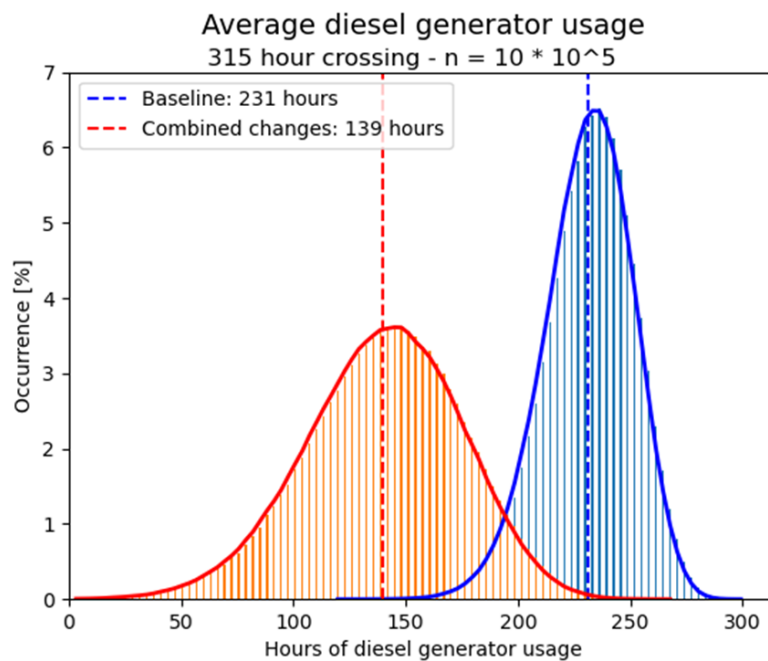

Figure 11: The effect of combined design changes on the average diesel generator running hours.

CONCLUSION

Hydro generation is expected to go from a niche to a common feature on sailing yachts in the coming years. A method is developed that allows for an exploration of various hydro generation components in the early design stage. This practical approach will assist yacht designers in designing more sustainable sailing yachts. Its applicability is shown by three examples for which a decrease in hotel load is found most effective in reducing the diesel generator running hours. For each design alteration, a total of 1 million routes were sailed to quantify its effect. The simulations were carried out using main particulars and first principles only. The design alterations proposed did not materialize in a significant increase of the success rate. Each design alteration did lead to a decrease in average diesel generator running hours; indicating less emissions.

The case study is concluded by combining the three design alterations and implementing them simultaneously. The calcu-

lations show this combination to be more effective than the sum of its parts. The 41% decrease in diesel generator running hours is 1.7 times larger than the sum of the separate solutions, which amounts to 22%. It suggests that the effect of one design alteration can benefit other alterations and act as a multiplier. The nature of this multiplier effect how it affects the outcome of the success rate, and whether it differs for different design change combinations, requires further research. This multiplier effect shows that it pays off to implement multiple small adjustments to a design rather than focusing on one major design change when considering hydro generation. A zero fuel crossing, as presented in the case study, is difficult to achieve by applying adjustments to an existing yacht. Using the design method during the initial design process helps to make this achievement more realistic on a new sailing yacht.

RECOMMENDATIONS

During this study, several assumptions and simplifications were made. It is recommended to further investigate these assumptions to improve the developed method.

- The current approach to determining the hotel load relies heavily on a database comprised mainly of motor yachts, hence it was chosen to correct for this with an average ratio based on on-board measurements. An improvement in the estimate for hotel loads of sailing yachts is therefore recommended. This can be achieved by using a database of sailing yachts within the design range of the method, and cross-reference with full-scale measurement data.
- At this moment the force and energy balance is considered for the yacht sailing in an upright condition. However, it is well known that sailing yachts tend to sail with heel and leeway. The effect of this on the performance of the hydro generation systems is to be further investigated.

CONTRIBUTION STATEMENT

Author 1: Conceptualization; data curation, methodology; writing – original draft.

Author 2: Supervision; writing – review and editing.

Author 3: Supervision; writing – review and editing.

REFERENCES

Gerr, D. (1989). *The Propeller Handbook*.

Keuning, J. and Sonnenberg, U. (1998). Approximation of the Hydrodynamic Forces on a Sailing Yacht based on the 'Delft Systematic Yacht Hull Series'. In *15th International Symposium on "Yacht Design and Yacht Construction"*, volume 15, pages 99–152.

Kuiper, G. (1991). *Resistance and Propulsion of Ships*. Delft University of Technology, Delft.

MacKenzie, P. M. and Forrester, M. A. (2008). Sailboat propeller drag. *Ocean Engineering*, 35(1):28–40.

van Eesteren Barros, J. P. (2022). *Modeling the Electric Power Consumption of a Yacht*. Master thesis, Delft University of Technology.

van Lammeren, W. P. A., van Manen, J. D., and Oosterveld, M. W. C. (1969). The Wageningen B-Screw Series. *SNAME Transactions*, page 43.

Verma, J. and Kumar, D. (2021). Recent developments in energy storage systems for marine environment. *Materials Advances*, 2(21):6800–6815.