

Design of the strut braced wing aircraft in the agile collaborative MDO framework

Torrigiani, F.; Bussemaker, J.; Ciampa, P. D.; Fioriti, M.; Tomasella, F.; Aigner, B.; Rajpal, D.; Timmermans, H.; Savelyev, A.; Charbonnier, D.

Publication date

2018

Document Version

Final published version

Published in

31st Congress of the International Council of the Aeronautical Sciences, ICAS 2018

Citation (APA)

Torrigiani, F., Bussemaker, J., Ciampa, P. D., Fioriti, M., Tomasella, F., Aigner, B., Rajpal, D., Timmermans, H., Savelyev, A., & Charbonnier, D. (2018). Design of the strut braced wing aircraft in the agile collaborative MDO framework. In *31st Congress of the International Council of the Aeronautical Sciences, ICAS 2018* (31st Congress of the International Council of the Aeronautical Sciences, ICAS 2018). International Council of the Aeronautical Sciences.

Important note

To cite this publication, please use the final published version (if applicable).
Please check the document version above.

Copyright

Other than for strictly personal use, it is not permitted to download, forward or distribute the text or part of it, without the consent of the author(s) and/or copyright holder(s), unless the work is under an open content license such as Creative Commons.

Takedown policy

Please contact us and provide details if you believe this document breaches copyrights.
We will remove access to the work immediately and investigate your claim.



DESIGN OF THE STRUT BRACED WING AIRCRAFT IN THE AGILE COLLABORATIVE MDO FRAMEWORK

F. Torrigiani*, J. Bussemaker*, P.D. Ciampa*, M. Fioriti[§], F. Tomasella[§], B. Aigner[¶],
D. Rajpal[†], H. Timmermans[‡], A. Savelyev[‡], D. Charbonnier^{||}

*German Aerospace Center (DLR), [§]Politecnico di Torino, [¶]RWTH Aachen
University, [†]Delft University of Technology, [‡]Netherlands Aerospace Center (NLR),
[‡]Central Aerohydrodynamic Institute (TsAGI), ^{||}CFS Engineering

Keywords: *Strut Braced Wing, Multidisciplinary Analysis & Optimization, On Board
Systems Design, Cost & Emissions Analysis*

Abstract

The paper describes the deployment of the AGILE Development Framework to investigate the Strut Braced Wing aircraft configuration.

The design process consists of a multilevel multidisciplinary architecture, progressing from the initial conceptual synthesis to the physics based analysis. All the main disciplinary domains, including on board system design and cost assessment, are accounted for in the assembled workflow. Due to the specific characteristics of the Strut Braced Wing configuration, the aeroelastic analysis is the main focus of the study and it is addressed at both high and low fidelity levels. The integration of the engine-wing system is also included in the design process. All the design competences, which are hosted at the different partners, communicate via CPACS (Common Parametric Aircraft Configuration Schema) data schema.

All the results generated, including the multidisciplinary design process itself, will be published and made available as part of the AGILE Overall Aircraft Design database.

1 Introduction

In the recent studies, Strut Braced Wing (hereafter referred to as SBW) aircraft has gained attention as a promising solution to meet the increasing demand of fuel and emissions reductions. However, the design of an

unconventional configuration, such as the SBW one, poses ambitious challenges in terms of methodology and results assessments; several projects have dealt with different aspects of this challenging design problem.

The Subsonic Ultra Green Aircraft Research N+3 (SUGAR N+3) [1] studied conventional, blended wing body, and SBW configurations in the 2030-2035 scenario. Design and analysis concentrated on a medium size aircraft, 154 passengers, and the different configurations were compared for a 900 nm mission. The study highlights that when coupled with hybrid propulsion, the SBW configuration resulted to be the best solution in terms of fuel burn reduction.

In phase I of SUGAR, the research mainly focused on the impact of new propulsion technologies, and although detailed analyses on structure, aerodynamics and propulsion systems were included in design process, only two iterations of the overall Multidisciplinary Analysis (MDA) have been performed. Such a limitation on the number of iterations could result in an underestimation of the novel configuration benefits. Improvements in the automatization of the design process are necessary to avoid this issue.

The ONERA's internal research project ALBATROSS [2] studied a SBW configuration with 180 passengers, nominal range of 3000 nm, cruise Mach number 0.75, and two rear fuselage mounted turbofan. The design approach

consisted of 3 steps. At first a preliminary design process based on semi-empirical formula optimized the aircraft for fuel burn and DOC in terms of engine size and flight level. Thereafter, high fidelity aerostructural simulations and handling qualities analysis were used to assess the actual benefits of the SBW configuration. Finally, a parametric study has been conducted varying 4 parameters, namely: the strut curvature, the strut-wing connection position in chord and span directions, and the strut thickness.

In the first phase of ALBATROS project, only a restricted subset of the design space has been explored, and the effort to integrate the different analysis tools in a Multidisciplinary Design and Optimization (MDO) process has been relegated to a second and dedicated part of the project.

In the DLR's internal project FrEACs [3] a collaborative design approach has been applied to the study of a single-aisle 150 passengers SBW. When compared to a conventional configuration with similar Top Level Aircraft Requirements (TLAR) the SBW configuration shows a significant reduction in fuel burn, especially if the span constraint of 36 m is relaxed to the next airport category (52 m). Moreover, the FrEACs project highlighted the increase of confidence level that can be obtained by effectively integrating the disciplinary knowledge of the specialist involved in the design process.

The lack of reliable statistical experienced-based methods for unconventional configurations, such as the SBW, led each of the mentioned projects to introduce physics based analyses in the early phases of the design process. In this kind of design environment particular attention must be dedicated to the definition of a suitable design process, and to the integration of the involved disciplinary competencies. Otherwise, the risk is to explore only a restricted portion of the design space, or to interrupt prematurely the converging MDA, limiting the exploitation of non-conventional configurations benefits.

The European funded AGILE project [4] is developing the next generation of aircraft

Multidisciplinary Design and Optimization processes, and in the Design Campaign 3 the developed framework is deployed to investigate five novel aircraft configurations. In this paper the application of the AGILE Development Framework (ADF) to the problem of the SBW design is presented. In section 2 the setup and the deployment of the overall aircraft design process is described together with the disciplinary tool involved in the process. In section 3 the results for the SBW are shown. Finally, in section 4 and 5 future developments of this work and conclusions are presented.

2 Design Approach: Application of the AGILE Development Framework to the SBW Design Problem

Strut-braced configurations with very high aspect ratios wings and low sweep angles (HARLS) are investigated in this design task. The tight coupling between aerodynamics and structures, typical of the SBW configuration, has been extensively investigated in literature [6] [7]. The strut relieves the wings bending-moment and allows high aspect ratio wing with small wing thickness, resulting in low induced drag and in low wave drag design. On the other hand, the strut supporting the wing creates a significant drag penalty. In FrEACs project was found that the optimal solution has extremely high aspect ratio, up to 20. However, the increase of aspect ratio might be limited by the maximum span constraint which is imposed by the airport classes. The option of a main wing folding mechanism is considered in this work when such a constraint becomes a limitation of the design space. Compression of the strut under certain load cases such as during landing can potentially be critical, as well as the large flexible behaviour typical of HARLS wings.

The focus of the current design process is:

- The aeroelastic tailoring of composite wing and strut
- The aeroelastic deformation for the aerodynamic polar calculation of the flexible aircraft
- The integration of the engine\wing system.

The AGILE Framework defines models and platforms which enable and automate the definition and the implementation of the SBW design and optimization process. The use of a central data model for exchanging information among partners significantly reduces the number of connections between the simulation tools and reduces the presence of duplicated and inconsistent information. Therefore, CPACS [8] is used as the standard format for input and output files of each disciplinary competence.

The design process is configured, deployed and executed in RCE [9], an open source integration environment developed by DLR. RCE allows the integration of remotely dislocated tools within the same organizational environment. However, in this case, five partners of the AGILE consortium were directly involved in the execution of the design process, namely: DLR, TUD, NLR, POLITO, and RWTH. Therefore, Brics [10] component developed by NLR, is used and integrated into RCE in order to enable cross-organizational connections. Details on the AGILE cross-organizational setup are reported in [4].

The management of the development process is implemented into the KE-chain web-based platform [11], used as a front end to setup the overall design process according to the five-steps approach of the AGILE Paradigm. The following subsections describe the application of each of the five steps approach to the SBW design problem.

2.1 The SBW Design Case and Requirements

The design requirements and the transportation mission of the reference aircraft are specified by the Industrial Partners and delivered to the AGILE Consortium. The SBW TLAR, summarized in Tab. 1, are selected to design a configuration that might compete in terms of transportation mission with the AGILE reference aircraft, developed during the first and second year of the project [5]. Therefore, the AGILE SBW is a 90-seats passenger configuration, offering a mission profile comparable with the DC-1. Engines are wing-mounted and, differently than the DC-1

configuration, the AGILE SBW is a high-wing configuration with T-tail.

2.2 The SBW Data Model

Given the TLAR, the SBW configuration is initiated using the conceptual aircraft design tool VAMPzero [12], which contains conceptual design rules derived from previous project. A set of preliminary analyses are performed on this initial configuration, especially in order to identify the design aspects that are not directly integrated in the automated design and optimization workflow. In particular the engine position and the airfoils are defined in this preliminary phase.

Tab. 1: Top Level Aircraft Requirements

Requirements	Unit	AGILE SBW
Design Range	[km]	3500
Max. payload	[kg]	11500
Number of Passengers		90
Long Range Cruise Mach		0.78
Initial Climb Altitude	[m]	11000
Maximum Operating Altitude	[m]	12500
TOFL (ISA, SL, MTOW)	[m]	1500
Vref (ISA, SL, MLW)	[kts]	< 130
Max. op. speed V_{mo} / M_{mo}		330 KCAS / 0.82
Dive Mach number (M_d)		0.89
Fuselage diameter	[m]	3
Fuselage length	[m]	34
Fuel reserves		5% (100 nm)
Airport Category		ICAO C
Engine Type		TF
On-board systems		AEA

Due to the similarities in the requirements, the same engine deck of the AGILE reference configuration is used. The position of the engine is defined according to conventional aerodynamic behavior for under-wing engine and geometrical requirements. Also, it was taken into account that the position of the strut-wing attachment is one of the design variables and will vary in the future. Euler simulations are performed by TSAGI to assess the impact of engine and nacelle on the overall aircraft aerodynamics. A comparative study of two configurations at altitude 11000 m and Mach 0.78 is carried out: wing-fuselage (WF) and wing-fuselage-nacelle (WFN). Unstructured computational grids were used: grid with 3.3 million cells for WF configuration and with

5.8 million for WFN. Calculations were performed by TSAGI using the open-source CFD Code SU2 [13].

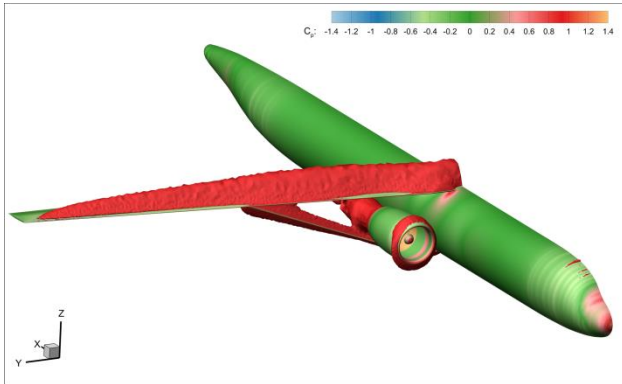

Fig. 1: Contour plot of pressure coefficient and (in red) iso-surface of Mach = 1. Results obtained by TSAGI for the initial configuration.

Although, a decrease of aerodynamic efficiency of approximately 10% is obtained when engine and nacelle are included, a lift coefficient of 0.44, at 0° of angle of attack, indicates that the chosen position and dimension of the nacelle is acceptable. Independently from the presence of the nacelle, the simulations shows a shock wave along the wing and the strut, as shown in Fig. 1, and the drag contribution of the strut almost equivalent to the wing's one.

In order to investigate the issue on the wave drag, a comparison is carried out by CFSE on four variations of the baseline configuration assessing the impact of supercritical airfoils and sweep.

2.2.1 Hi-Fi aerodynamic comparison on preliminary SBW configurations

Four different configurations are analyzed by CFSE with the Navier Stokes Multi Block solver NSMB [14]. NSMB is a parallelized CFD solver employing the cell-centered finite volume method using multi block structured grids to discretize the Navier-Stokes equations. The patch grid and the Chimera grid approach are available to facilitate the grid generation for complex geometries. In addition, the Chimera method is used for simulations involving moving bodies [15].

Various space discretization schemes are available, among them the 2nd and 4th order central schemes with an artificial dissipation and Roe and AUSM upwind schemes from 1st to 5th order. Time integration can be made using the explicit Runge-Kutta scheme, or the semi-implicit LU-SGS scheme. Various methods are available to accelerate the convergence to steady state, as for example local time stepping, multigrid and full multigrid, and low Mach number preconditioning. The dual time stepping approach is used for unsteady simulations.

In NSMB turbulence is modeled using standard approaches as for example the algebraic Baldwin-Lomax model, the one-equation Spalart model [16] (and several of its variants) and the $k-\omega$ family of models (including the Wilcox and Menter Shear Stress models). Hybrid RANS-LES models are available, and the code includes also a transition model solving transport equations [17].

NSMB includes re-meshing algorithms that are employed for bow shock capturing for hypersonic flow problems, and for re-generation of the grid when the structure is deformed. The re-meshing procedure is a combination of Volume Spline Interpolation (VSI) and Transfinite Interpolation (TFI). When using Chimera grids, the remeshing procedure is carried out in each Chimera grid independent of the other surroundings Chimera grids.

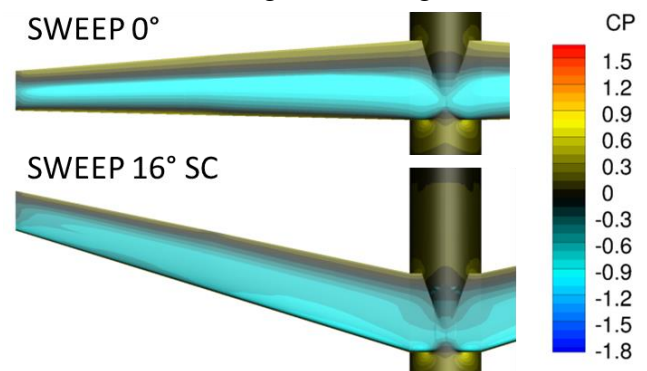

Fig. 2: Comparison of pressure coefficient contour plot for Mach=0.78 obtained by CFSE.

Results are summarized in Tab. 2 (SC indicates configurations with supercritical airfoils), and show a significant increase of aerodynamic efficiency when supercritical

airfoils are combined with a sweep angle of 16° for the cruise condition defined in TLAR¹.

Tab. 2: Aerodynamic efficiency obtained by CFSE with hi-fi aerodynamic simulations. The same lift coefficient (0.48 and 0.55 for Mach 0.70 and 0.78 respectively) is used to compare the four configurations².

<i>CL/CD</i>	<i>M</i> = 0.70		<i>M</i> = 0.78	
sweep 0°	14.9		8.7	
sweep 0° SC	13.9	-6.2%	10.6	+22.2%
sweep 16°	15.3	+2.8%	10.2	+17.6%
sweep 16° SC	14.3	-3.6%	13.3	+52.3%

Moreover, results obtained with NSBM simulations show that the drag contribution of the strut is one order on magnitude lower than the wing's contribution.

2.3 The SBW Design Competences

The design competences available at partners' sites and integrated in the RCE design workflow as remote services are briefly described in the following.

- **Overall Aircraft Design (OAD) initialization:** *VAMPzero* is an open source conceptual aircraft design tool developed by DLR. Starting from TLAR the overall aircraft configuration is initiated according to well-known handbook equations. The generated CPACS files provide the aircraft outer geometry as well as the main structural elements.
- **Composite aeroelastic tailoring:** *PROTEUS* is a composite aeroelastic tailoring tool, developed at the Delft University of Technology. In *PROTEUS*, geometrically nonlinear Timoshenko beam model is coupled to a vortex lattice aerodynamic model to perform non-linear aeroelastic analysis. A linear dynamic aeroelastic analysis is carried out around the non-linear static equilibrium solution. For

¹ The sweep of 16° was selected with Korn's equation for a Mach number of 0.78, a wing average thickness to chord ratio of 12%, and considering the modification due to the supercritical airfoils.

² Percentage values indicated the difference with respect to the sweep 0° configuration with non supercritical airfoils.

the stiffness and thickness optimization of the composite wing, analytical derivatives of the objective and constraints with respect to the design variable are calculated and gradient-based optimizer, GCMMA, is used for optimization. Wing and strut structural mass as well as flutter speed are the main outputs of this remote service.

- **Rigid body aero-performance analysis:** this service provides the full set of aircraft polars which will be used by the mission simulation tool. The service is composed by two tools.
 - *pAir*: DLR's in-house developed panel method code for steady aerodynamic analysis. In the pre-processing the aircraft outer surface is extracted from CPACS and the aerodynamic model is generated. Two different level of fidelity can be set: a 2D flat lifting surfaces method; or a 3D steady panel method. For this task the 2D abstraction has been chosen. Aircraft polars, in terms of angle of attack, angle of yaw, Mach number, defined in the input file, are computed.
 - *VRaero*: DLR's in-house developed tool for viscous drag calculation. According to the flat plate equivalence, the viscous contribution, for different Reynolds number, is added to the induced drag computed by the previous potential aerodynamic analysis tool.
- **Flexible body aero-performance analysis:** this service provides as output the aircraft polars with higher level of fidelity with respect to previous rigid body analysis. Computations are carried out by the NLR's tool *AMLoad*, and the structural deformation due to the aerodynamic load is considered for polars calculation. The structural characteristics, in terms of stiffness and mass distribution, previously calculated by the composite aeroelastic tool are used.
- **Secondary mass estimation:** so far only the sizing of the wing-box primary structure is calculated by the previous structural tool. The DLR's tool *wiSe* is an estimation module for the secondary airframe masses. Based on the geometrical data an estimation of the masses of several components is

performed, such as moveables (flaps, ailerons), engine pylons, landing gear attachments, actuators attachments, and other non-primary masses.

- **On board systems design:** the OBS design process is carried out with ASTRID tool developed in Politecnico di Torino [18]. The OBS module uses both physics-based and semi-empirical algorithms to calculate the OBS masses, the power required by each OBS and the volume of each main equipment. The OBS masses are defined at sub-system (i.e. electric, hydraulic, flight control systems etc.) and at main equipment level (i.e. electric generator, hydraulic pump, actuator etc.). The data required to run the module are at aircraft and OBS level. At aircraft level, ASTRID requires the main aircraft masses, dimensions (e.g. wing and fuselage geometries) and the aircraft mission profile in terms of altitude, speed and duration of each mission phase. The module is able to assess the main OBS users such as Flight Control System (FCS), landing gear actuation and structure, avionics, Ice Protection System (IPS), Environmental Control System (ECS) and fuel system. After assessing the power required by the users, ASTRID is able to design the power generation and distribution systems such as electric, hydraulic and pneumatic systems. In OBS design module the algorithms are able to design all electric and more electric architecture as well as standard one.
- **Engine deck:** this module provides the engine deck with the relative performance map. The engine deck is chosen according to baseline characteristics and kept fixed throughout the aircraft optimization process.
- **Mission simulation:** the DLR's *FSMS* tool assesses the possibility to fly the defined mission profile, in terms of required thrust, and determines the mission and the reserve fuel mass.
- **Cost and Emissions analysis:** The cost and emission analyses provided by RWTH Aachen University calculate non-recurring (NRC), recurring (RC) as well as operational costs (OC) for an aircraft configuration using semi-empirical methods.

These methods were partly adapted from literature and partly in-house developed at the Institute of Aerospace Systems of RWTH Aachen University. Additionally, the exhaust emissions for a flight mission and their estimated impact on the environment (e.g. radiative forcing, global warming potential) are calculated using a semi-empirical climate model. The methods were developed by Lammering et al. [29] and Franz et al. [30] [31]. Within the presented framework, the main influence on the RC are the component masses from the structural analysis, secondary mass analysis and the on-board systems design. For DOC and emissions, additionally, the mission simulation results from DLR's *FSMS* are taken into account.

The optimization and the analysis processes carried out internally by the composite aeroelastic tailoring service are computationally expensive and approximately one day is necessary to run 10 configurations. In order to extensively explore the design domain and to not limit the number of converging iterations, TUD creates and deploys the surrogate of the tool PROTEUS. The definition of the surrogate's input and output (I/O) parameters highly affects the implementation of the connected tools and the overall design process.

For instance, the flexible body aero-performance analysis needs the stiffness and mass distribution defined by PROTEUS, but this information is too complex to be used as one of the surrogate outputs. Therefore, this information is implicitly assumed by the flexible aero-performance analysis. In order to do that, also NLR builds the surrogate of AMLoad using the stiffness and mass distribution computed by PROTEUS, but then only the design variables are used as surrogate input. The analyses and the tight coupling between the two disciplinary competences, as well as the surrogate building, are extensively described in the companion article [21].

Although, the two competences have their own surrogates, they have exactly the same input parameters and basically work as a single

surrogate which, given the independent design variables, computes as output the wing and strut masses, flutter speed and the flexible aircraft polars.

2.4 The SBW Multidisciplinary Design Analysis and Optimization Architectures

As soon as the data model is available, compliant with TLARs, the whole set of competencies use the reference data model as I/O model, are tested, and ready to be deployed for a design and optimization process. At this stage KADMOS [22] enables the generation and manipulation of the MDAO architecture.

Using the visualization toolkit VISTOMS [4], the connections among the different competencies are inspected in details and the MDA strategy is defined accordingly.

For instance, the Operative Empty Mass (OEM) section, in the CPACS schema, is consistently updated by several tools, namely the aeroelastic tailoring, the secondary mass estimation, and the on board system design tool. Whereas, in order to reduce the number of convergence iterations the Take-Off Mass (TOM) is updated only after the mission simulation that compute the block fuel mass. This results in a MDA with all the tools inside a converging loop except the cost and emissions calculation tool (see Fig. 3), which needs the TOM, OEM and fuel mass as input but does not update any of them. TOM is the converging variable.

Wing aspect ratio, wing span, sweep (the same sweep angle is used for wing, strut, horizontal and vertical tail plane), strut-wing attachment position (in terms of span ratio),

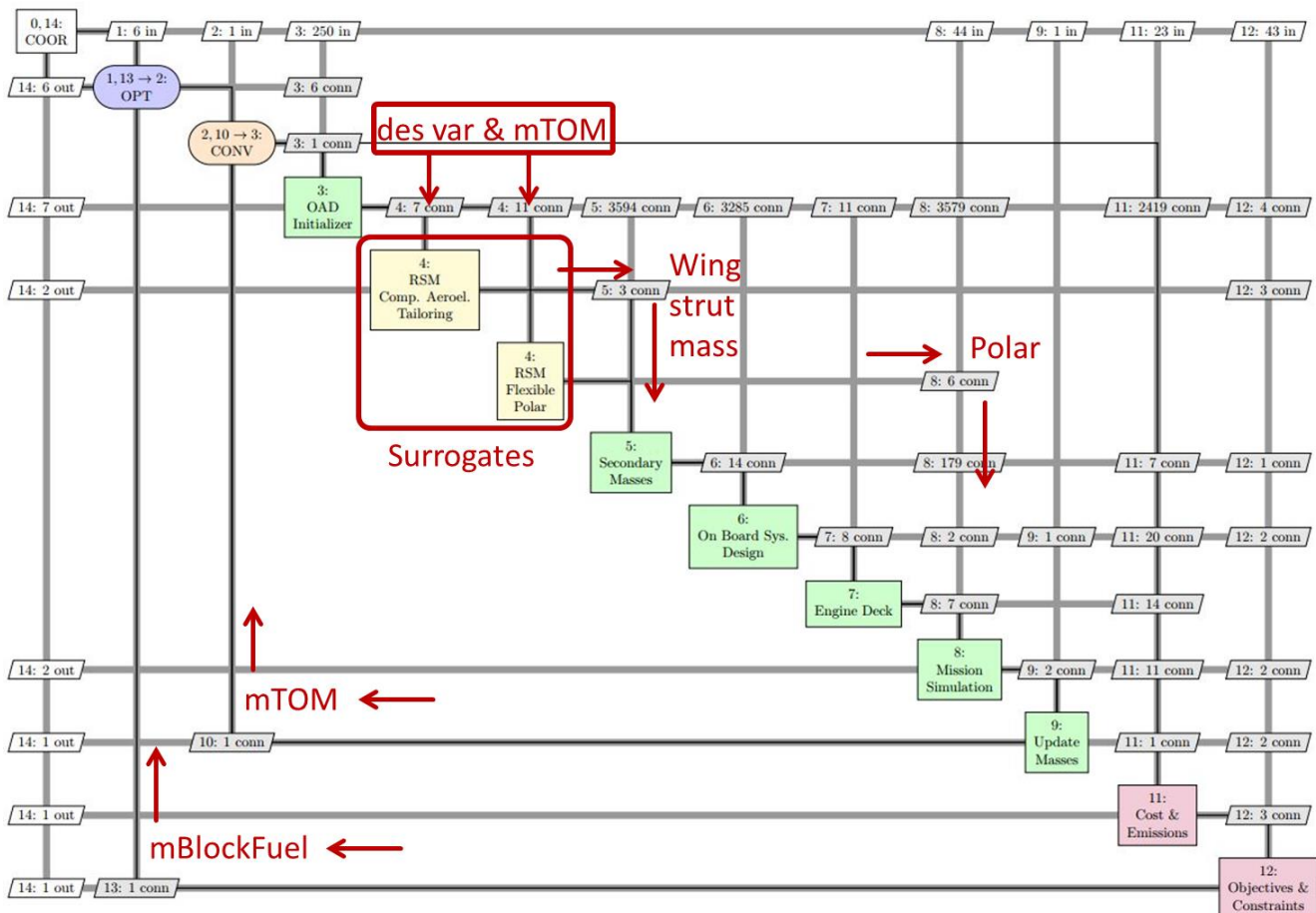

Fig. 3: XDSM of the MDF architecture deployed for the AGILE SBW aircraft. Design competencies provided by DLR, TUD, NLR, POLITO and RWTH. The thick grey lines represent the data flow. Whereas, the thin black line represents the process execution flow, and the numbers before the colon indicate the order of execution. The number of nodes involved in the connection is also indicated. As can be seen some connections involve a high number of nodes, meaning that the geometry of the configuration is involved.

wing and strut thickness to chord ratio are the design variables for the DOE study and the following optimization. Tab. 3 collects the DOE ranges and indicates the baseline values. A Latin Hypercube distribution with 60 points is used as DOE sampling plan.

Tab. 3: DOE range of design variables baseline's values.

Design Variables	DOE Range	Baseline
Span [m]	28 - 42	36
Aspect Ratio	12 - 21	14
Sweep [°]	10 - 25	16
Strut-wing span position	0.5 - 0.8	0.55
Wing t/c	0.09 - 0.15	0.12
Strut t/c	0.09 - 0.15	0.1

The definition of the surrogate inputs highly affects the choice of the design variables. Here, all the design variables are also surrogate inputs, and the TOM is part of them as well. Parameters, which are input of the tool but not included among the inputs of the relative surrogate, cannot be used as design variable, since they are implicitly assumed constant by the surrogate. For example, the wing's taper ratio cannot be a design variables, because the composite aeroelastic tailoring uses the entire geometry of the wing and the taper ratio is not included among the PROTEUS surrogate inputs. Whereas the aircraft's range could be used as design variable, since it is not considered in either PROTEUS or AMLoad.

The block fuel mass and direct operating costs are the objective variables of the optimization problem. A constraint is defined on the block fuel mass, which has to be smaller than the maximum fuel mass allowed by the wing tank volume. The other constraint is set on the flutter speed calculated by the aeroelastic tailoring tool. It has to be higher than the maximum operating speed defined in the TLAR.

Once the MDA strategy, the design variables, the objective and the constraints functions are all correctly and coherently defined, KADMOS enables the automatic generation of different MDAO architectures, ranging from converging MDA to Multi-Disciplinary Feasible (MDF) or Individual Discipline Feasible (IDF) optimization

architecture. Furthermore, the generated MDAO architectures are stored in CMDOWS [23] format, a neutral formalization of the MDOA problem that allows the automatic implementation of the correspondent executable workflow.

The MDF architecture is obtained and tested but not yet executed as direct optimization. As a preliminary step, a surrogate of the whole design process is built using the results of the DOE, and the optimization is carried out on the surrogate.

2.5 Implementation and Execution of the Automated Design Workflow

The ADF offers several ways to implement the disciplinary competencies (remote service, local tools, or equation), and two different platforms for the workflow process integration and deployment (RCE or Optimus). In this study, all the competencies are provided by the partners as remote services and accessed by the main workflow implemented in RCE via Brics component. The remote services are composed by tools and scripts implemented in RCE. The DOE workflow used for the SBW study is shown in Fig. 4, together with some of the connected remote services workflows.

Brics technology is used also when the services are hosted on the same machine of the overall workflow. This avoids the failure of the overall workflow in case one of the remote services fails.

An important feature of the SBW design process is the presence of the OAD initialization tool inside the MDA converging loop. At each iteration, the overall aircraft configuration is re-synthesized according to the same design variables but for the updated TOM value, allowing the full exploitation of the so called "snowball effect". On the other hand, this raises challenges from the implementation point of view. According to the new value of the TOM, some topological changes may occur, like a change in the number of control surfaces. Then, a strict check on this kind of information might cause the failure of the overall workflow. This happened with the first implementation of the SBW workflow, and led to the redefinition of

the I/O files for some of the design competencies.

Therefore, it was decided to limit to 3 the number of MDA converging iterations for the

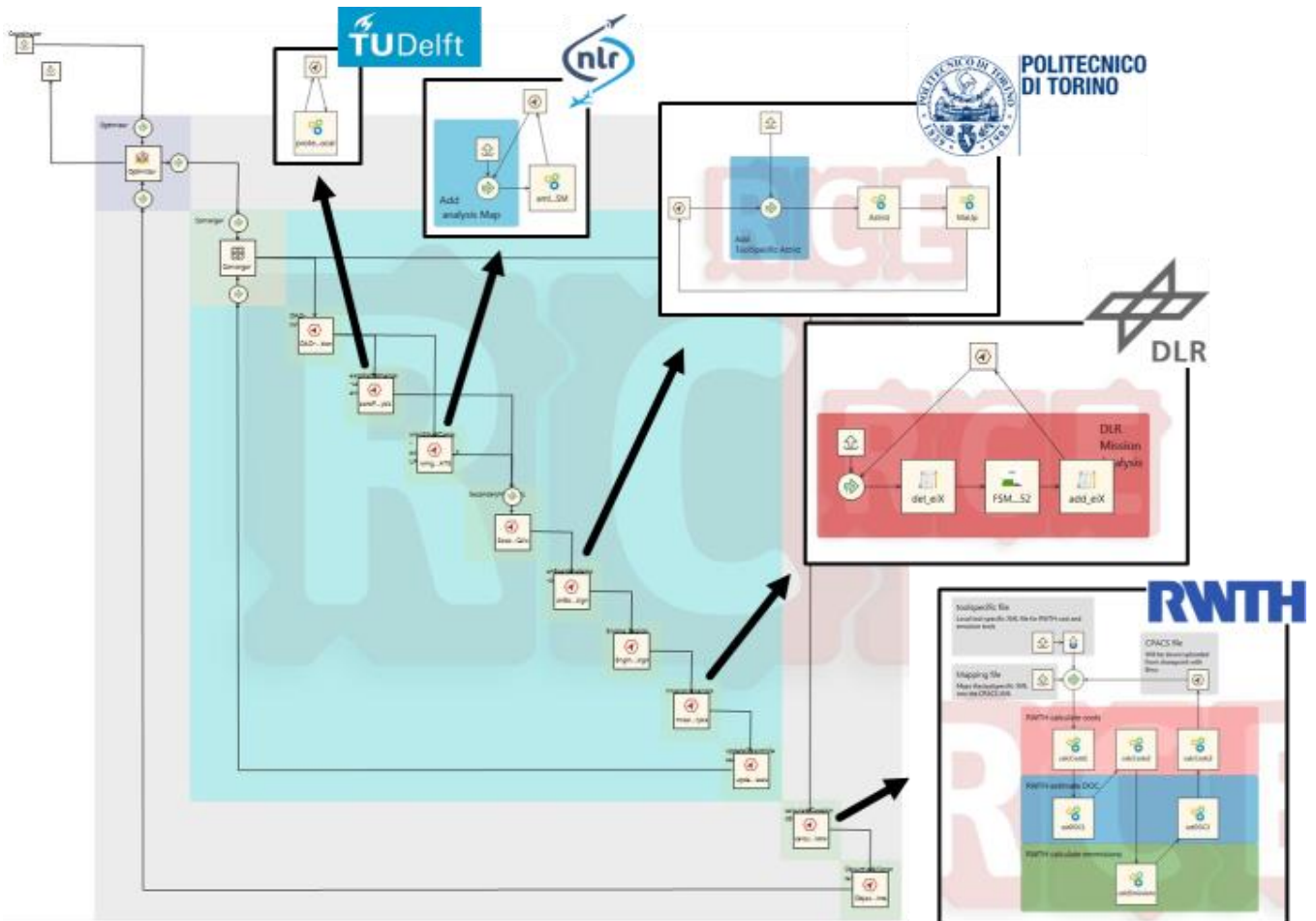

Fig. 4: Implementation of the MDF architecture as RCE workflow. Each design competency is a remote service hosted at partners' sites, and provided to the overall workflow via Brics. On the right side some of the remote services workflows are also shown.

3 Results of the SBW Design Process

The MDA results of the SBW baseline configuration and DOE results are collected in the following subsections.

3.1 Multi-Disciplinary Analysis of the SBW Baseline Configuration

The values of the design variables for the baseline configuration are shown in Tab. 3. The MDA converging trends of TOM, OEM, and fuel mass are depicted in Fig. 5. All the three parameters show a good convergent behavior; after 3 iterations the difference with respect to the final value is already below 0.5%.

DOE study. As expected the first iteration corresponds to the highest “jump”. This is, in terms of TOM, a difference of 2% which is approximately equal to 820 kg.

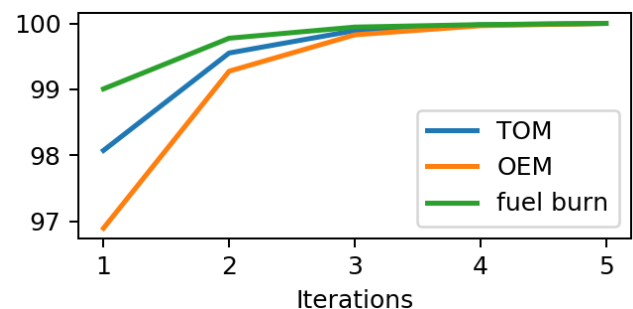

Fig. 5: MDA converging trends (percentage).

The obtained mass breakdown is reported in Fig. 6. The block fuel mass, which is the sum of fuel burn for the mission and reserve fuel, is 17% of the TOM and this percentage is similar to the one obtained for the AGILE reference configuration.

mTOM = 40898 kg

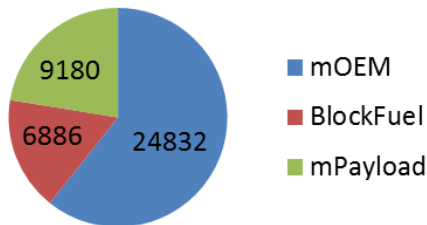

Fig. 6: High level mass breakdown for the SBW baseline configuration.

Going into the details of the structural masses (Fig. 7), the wing mass is the 40% of the overall structural mass, and 7.5 times higher than the strut mass. Both wing and strut mass are computed by the composite aeroelastic component and then updated by the secondary mass estimation component. The ongoing hi-fi aeroelastic analyses show an elevated flexibility of the strut, suggesting that its mass might be underestimated. Details and results of this activity are collected in the companion paper [21].

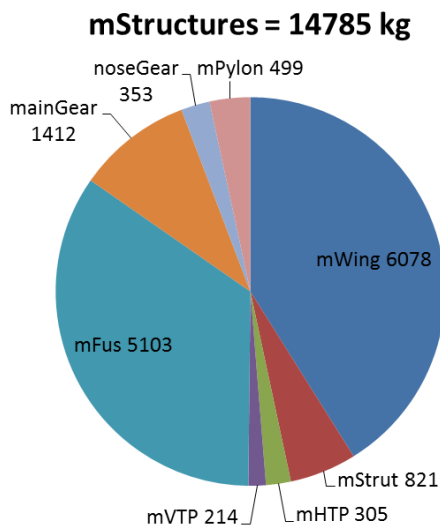

Fig. 7: Structures mass breakdown for the SBW baseline configuration.

The other structural masses are estimated with a lower level of fidelity. Landing gear mass

is computed by the on board system design competency, whereas pylon mass is estimated as a wing secondary masses. The OAD initialization competency is responsible for the calculation of fuselage, horizontal tail plane and vertical tail plane masses.

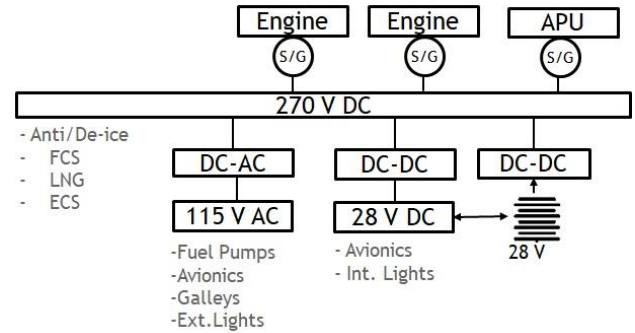

Fig. 8: OBS architecture for SBW baseline.

According to TLAR and previous studies [19] [20] the All-Electric Aircraft (AEA) architecture is adopted for OBS design of the AGILE SBW configuration. The proposed OBS architecture is depicted in Fig. 8. All OBS are electrically supplied removing hydraulic system and pneumatic bleed system. They are respectively replaced with Electric Hydrostatic Actuators (EHA) and dedicated air compressors driven by electric motors. The IPS uses the electro thermal technology instead of aerothermal. In this way, the AEA results in a smaller OBS mass and in a reduction of the total power required [24] [25]. Moreover, removing the hot pipes of engine bleeding system and the hydraulic oil, some potential catastrophic events are eliminated increasing the aircraft safety level [26] [27]. Considering the amount of electric power required, high voltage main bus (i.e. 270 VDC) is selected for primary generation and more standard voltages (i.e. 115 VAC, 28 VDC) are derived using specific electric transformers. The high voltage bus supply the users that requires more power such as ECS motors, FCS actuators and IPS thermal resistances. The other systems such as avionics, galleys and lights are supplied using the more common voltage for these users considering their availability also in case of All Engines Out (AEO) condition. Finally, both engines and Auxiliary Power Unit (APU) are provided with one electric

starter/generator that provide for OBS supply and engine starting functions [28].

The dedicated design competency, provided by POLITO, computes the detailed systems mass breakdown including furnishing, main and nose landing gear. Results for the baseline configuration are reported in Fig. 9. Excluding furnishing and landing gear that have heavy structural parts, the Electric Power Generation and Distribution System (EPGDS) is the heaviest system. This is in line with AEA architecture that totally relies on electric power generation and distribution. Avionics, ECS and FCS represent the secondary OBS mass items.

Power required by the different systems in the different phases of the defined mission is also computed (see Fig. 10). A maximum electric power of 190 kW is required during climb and descent phases of the mission when the IPS could be turned on. Engine offtakes, in terms of maximum required mechanical power per engine, are defined for the different phases of the mission. No air bleed is needed due to the all-electric architecture. In emergency condition (i.e. One Engine Out), the power should be totally provided by the operative engine. In all the other phases, both the engines should provide the power levels depicted in Fig. 10. Therefore, the emergency is the more demanding phase for propulsion system.

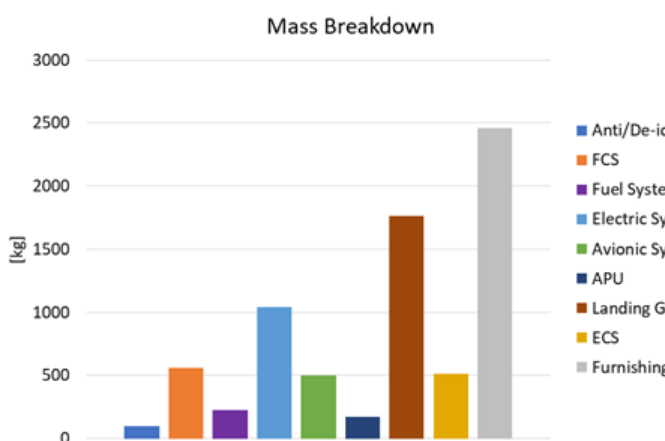

Fig. 9: On board systems mass breakdown for the SBW baseline configuration.

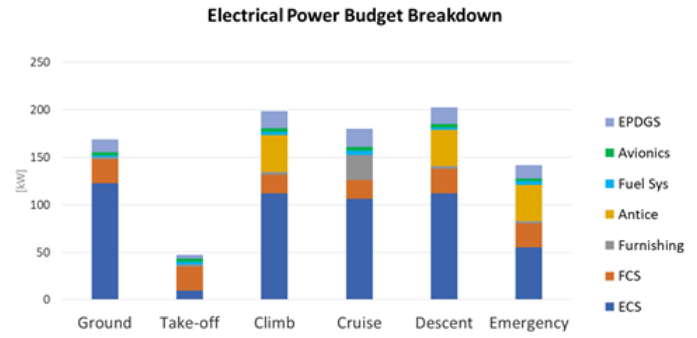

Fig. 10: Maximum electric power requirements breakdown for the SBW baseline configuration.

Individually, the most power demanding system is the ECS that should provide pressurized, fresh and conditioned air to the passengers and crew. From this point of view, other significant systems are IPS and furnishing (i.e. galleys, toilets, in-flight entertainment). In particular, the IPS of the SBW requires a consistent amount of power. However, the result is less than expected from the huge wing span of the SBW. This is due to the relatively short wing chord hence, a relatively thin wing thickness. Considering all this aspects, each starter/generator should be rated at 140 kW.

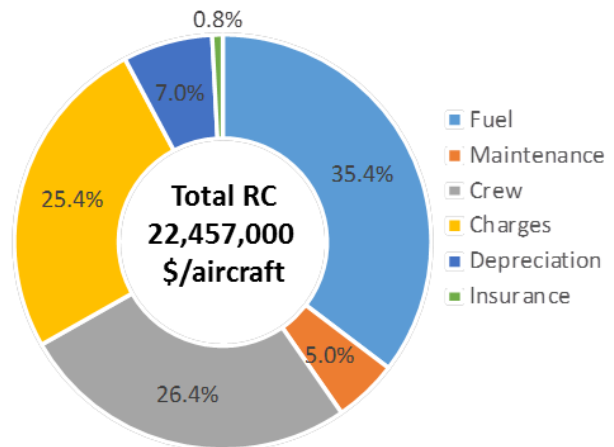

Fig. 11: RC breakdown for the SBW baseline configuration.

The cost and emission calculation competency provides a breakdown of the Recurring Costs (RC) and the Direct Operating Costs (DOC). In Fig. 11 and Fig. 12 the results obtained for the baseline configuration are shown. Please note that for reasons of simplicity only the high-level costs are displayed. The

actual level of detail for the cost parts goes as deep as for instance maintenance costs for each ATA-chapter in the systems breakdown.

Furthermore, a complete emissions map is calculated, which provides the emissions flow at each point of the defined mission. The SBW baseline produces a total amount of 16700 kg of CO₂ during cruise. Emissions are calculated not only for the mission, but also for the aircraft development and production phase.

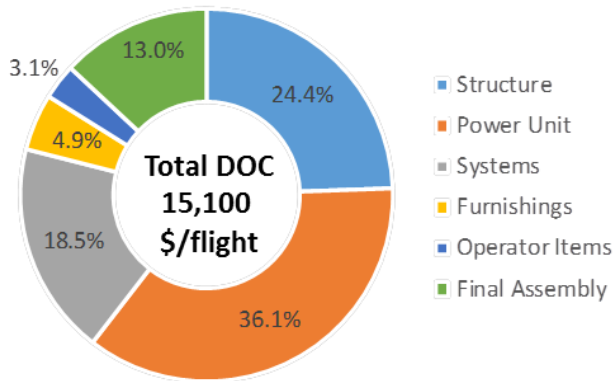

Fig. 12: DOC breakdown for the SBW baseline configuration.

3.2 Design of Experiment of the SBW Baseline Configuration

The DOE range for each of the six design variables is reported in Tab. 3. A Latin Hypercube distribution is chosen for the 60 points DOE sampling plan, and the correspondent surrogate is built to correctly interpret the results. In the following, where not explicitly specified, the value of the not shown design variables is constant and equal to the baseline value (reported in Tab. 3).

As a first analysis of the DOE results, the need of a folding mechanism is investigated. Fig. 13 shows that TOM, OEM and fuel burn mass are all increasing due to an increase of the wing span. Therefore, for this specific set of design variables there is no need of the folding wing. The dotted lines in Fig. 13 represent the error associated to the surrogate results.

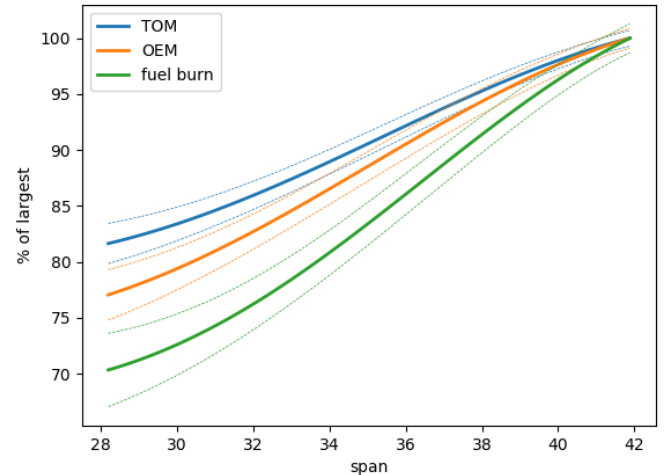

Fig. 13: Masses trend varying wing span.

In Fig. 14, the contour line of the block fuel mass with respect to wing's aspect ratio and span are shown. On the background the contour plot of the maximum fuel constraint. Red zones indicate a violation of the maximum fuel mass constraint, which means the block fuel mass is greater than the maximum allowable fuel mass.

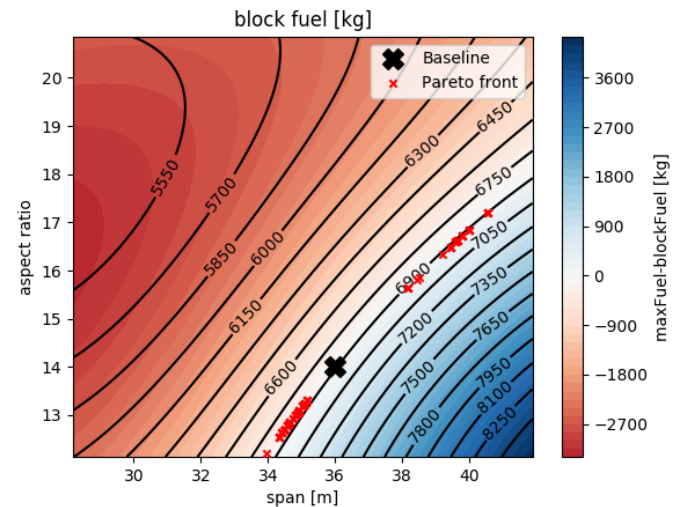

Fig. 14: Block fuel contour lines and contour plot of the maximum fuel constraint. Pareto points and baseline are also depicted.

The following trends are observed:

- The block fuel mass increases due to increasing wing span, for all the considered values of the aspect ratio.
- The block fuel mass decreases due to increasing aspect ratio, for all the considered values of the span.

- Combinations of low span and high aspect ratio, resulting in a small wing area, do not fulfill the maximum fuel constraint.

The same kind of information is displayed in Fig. 15. In this case the TOM's contour lines are depicted above the flutter constraint contour plot. Red zones indicate where the calculated flutter speed is below the maximum operating speed defined in TLAR. It is observed that:

- TOM shows the same trend of fuel burn with respect to both span and aspect ratio. It decreases for high aspect ratio and low span.
- Likewise the previous graph, combinations of low span and high aspect ratio, do not fulfill the flutter constraint.

For this specific set of design variables the maximum fuel constraint is qualitatively similar to a constraint on the maximum cruise lift coefficient. For instance, the baseline configuration, which is close to the border of the constraint, has a lift coefficient of 0.42. Whereas, for an extremal configuration with aspect ratio 20 and span 30 m, the lift coefficient is 0.86, that might lead to problem in low-speed conditions.

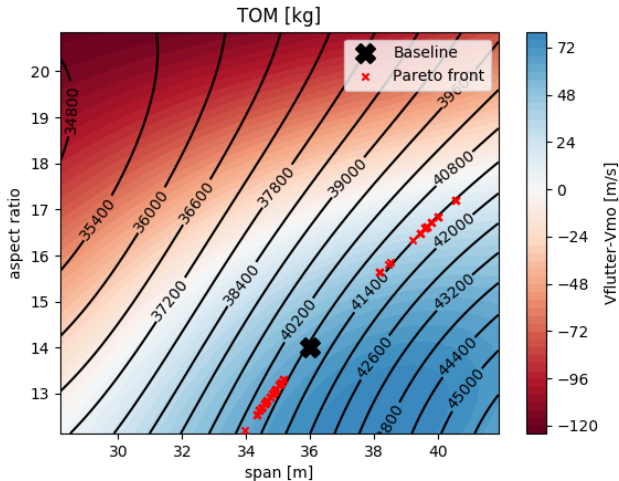

Fig. 15: TOM contour lines and contour plot of the flutter constraint. Pareto points and baseline are also depicted.

A multi-objective optimization is carried out using the surrogate. Span and aspect ratio are used as design variables and the objectives parameters are block fuel mass and direct operating cost (DOC). As can be seen in Fig. 14,

Fig. 15, the maximum fuel constraint is active for all the points of the Pareto front, whereas the flutter constraint plays no role.

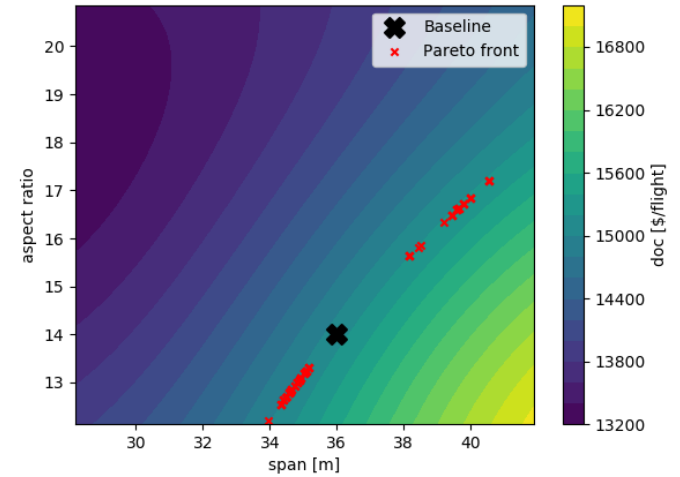

Fig. 16: DOC contour lines and contour plot of the maximum fuel constraint. Pareto points and baseline are also depicted.

Fig. 14 and Fig. 16 show the Pareto front points are divided in two groups. One group has lower block fuel mass than the baseline, and the other lower DOC values. Values of the two extremal points of the Pareto front, together with the baseline values, are collected in Tab. 4.

Tab. 4: Optimization results

Design Variables	Baseline	<i>min</i> Block Fuel	<i>min</i> DOC
Span [m]	36	40.5	34
Aspect Ratio	14	17	13
Block Fuel [kg]	6886	6826	6916
DOC [\$/flight]	15100	15107	15047

Using just aspect ratio and span as design variables only a minimum improvement with respect to baseline can be obtained. Because the baseline is close the border of the maximum fuel constraint, and both block fuel mass and DOC contour lines are almost parallel to the constraint lines. Thus, a third design variable is needed to significantly improve the baseline performance.

4 Future Developments

The baseline analysis is carried out using the flexible body aero-performance competence, whereas the DOE results are obtained using the

rigid body aerodynamic analysis. As a first prosecution of the work, the same DOE study will be done employing the flexible body competences in order to increase the results fidelity. The MDF architecture for the SBW design problem is tested and will be deployed.

Currently, NLR, TUD and CFSE are working at the high fidelity aeroelastic analysis, coupling a shell CSM model with a high fidelity Navier-Stokes simulation. Preliminary results show high displacements of the strut suggesting an underestimation of the strut mass. In order to correctly take into account this aspect an update on the structural sizing procedure might be necessary.

Due to the high aspect ratio wing, the SBW configuration can have handling quality problems, concerning in particular the roll performances. Flight mechanics analysis was not included in both MDA and DOE study, but the competence is available in the AGILE consortium and can be integrated in the design process.

5 Conclusion and lessons learnt

The AGILE Paradigm and the AGILE Development Framework have been deployed to set up the design process of the AGILE Strut Braced Wing configurations. A significant reduction in the time needed to assemble and implement the workflow has been observed.

Once the design competencies I/O are defined according to the data model, the MDAO architecture is automatically generated by KADMOS. The visualization toolkit VISTOMS eases the inspections of the competencies connections, and highlights inconsistencies in the workflow speeding up the recast of the design process. The effort of the workflow implementation is minimized thanks to the automatic parser between CMDOWS and the integration platform RCE.

However, the effort needed to make all the tools compatible to the data model is significant and not yet directly addressed by the AGILE Framework. The use of surrogates instead of the original tools requires additional attentions too. Usually not all the information can be included in the I/O definition of the surrogate, and,

hence, the tools connected to the surrogate must consider the excluded information implicitly.

The design workflow used to study the SBW configuration includes aerostructural analysis as well as on board systems design and cost and estimation calculation. The disciplinary competencies are provided by five members of the AGILE consortium, namely: DLR, TUD, NLR, POLITO and RWTH. Whereas preliminary analysis have been carried out by TSAGI and CFSE in order to define nacelle position and wing airfoils. TUD and NLR provided a surrogate model for their disciplinary competencies.

The workflow has been used to perform Multi-Disciplinary Analysis on the baseline configuration and a 60 points Design of Experiments with 6 design variables. A surrogate of the overall design process has been built using the 60 points of the DOE, and a multi-objective optimization has been carried out on this surrogate model.

The results obtained for the AGILE SBW configuration will be available as part of the AGILE database accessible via the AGILE web-portal [32].

Acknowledgments

The research presented in this paper has been performed in the framework of the AGILE project (Aircraft 3rd Generation MDO for Innovative Collaboration of Heterogeneous Teams of Experts) and has received funding from the European Union Horizon 2020 Programme (H2020-MG-2014-2015) under grant agreement n° 636202. The authors are grateful to the partners of the AGILE Consortium for their contribution and feedback.

References

- [1] M.K. Bradley, C.K. Droney, “*Subsonic Ultra Green Aircraft Research: Phase I Final Report*”, NASA/CR-2011-216847.
- [2] G. Carrier, O. Atinault, S. Dequand, J.-L. Hantrais-Gervois, C. Liauzun, B. Paluch, A.-M., Rodde, C. Toussaint, “*Investigation of a Strut-Braced Wing Configuration for Future Commercial Aircraft*”, 28th Congress of the International Council of the Aeronautical Science, 2012.

- [3] E. Moerland, T. Pfeiffer, D. Böhnke, J. Jepsen, S. Freund, C. Liersch, G. P. Chiozzotto, C. Klein, J. Scherer, Y. J. Hasan, "On the Design of a Strut-Braced Wing Configuration in a Collaborative Design Environment," 18th AIAA/ISSMO Multidisciplinary Analysis and Optimization Conference, Denver, Colorado, 2017.
- [4] P.D. Ciampa, B. Nagel, "*The AGILE Paradigm: the next generation of collaborative MDO*", 18th AIAA/ISSMO Multidisciplinary Analysis and Optimization Conference, Denver, 2017.
- [5] Prajwal S. Prakasha, Pier Ciampa, Pierluigi Della Vecchia, Benedikt Aigner, and Imco van Gent. "MDO Framework for university research collaboration : AGILE Academy Initiatives & Outcomes", 2018 Multidisciplinary Analysis and Optimization Conference, AIAA AVIATION Forum, (AIAA 2018-3254)
- [6] F. H. Gern, A. H. Naghshineh-Pour, E. Sulaeman, R. K. Kapania, R.K., R. T. Haftka, "Structural Wing Sizing for Multidisciplinary Design Optimization of a Strut-Braced Wing," *Journal of Aircraft*, Vol. 38, No. 1, pp. 154-163, 2001.
- [7] E. Sulaeman, R. K. Kapania, R. Haftka, "Parametric Studies of Flutter Speed in a Strut-Braced Wing," 43rd AIAA/ASME/ASCE/AHS/ASC Structures, Structural Dynamics, and Materials Conference, Denver, Colorado, 2002.
- [8] DLR, Air Transportation Systems, "Official CPACS Webpage," [Online]. Available: <http://cpacs.de>. [Accessed 27 07 2018].
- [9] DLR, German Aerospace Center, [Online]. Available: <http://rcenvironment.de> . [Accessed 27 07 2018].
- [10] E. Baalbergen, J. Kos, C. Louriou, C. Campguilhem and J. Barron, "Streamlining cross-organisation product design in aeronautics," in 6th EASN International Conference on Innovation in European Aeronautics Research, Porto, 2016.
- [11] KE Works, "KE-chain website," 2017. [Online]. Available: <https://www.ke-chain.com/platform>. [Accessed 27 07 2018].
- [12] DLR, German Aerospace Center, [Online]. Available: <http://www.cpacs.de/VAMPzero/> . [Accessed 27 07 2018].
- [13] Thomas D. Economon, Francisco Palacios, Sean R. Copeland, Trent W. Lukaczyk, and Juan J. Alonso. "SU2: An Open-Source Suite for Multiphysics Simulation and Design", *AIAA Journal*, Vol. 54, No. 3(2016), pp. 828-846
- [14] Vos, J., Rizzi, A., Corjon, A., Chaput, E., and Soenne, E. Recent advances in aerodynamics inside the NSMB (Navier Stokes multi block) consortium, 36th AIAA Aerospace Sciences Meeting and Exhibit, 1998.
- [15] Deloze T., Hoarau Y., Dusek J. Chimera method applied to the simulation of a freely falling cylinder in a channel, *European Journal of Computational Mechanics*, Vol 19/5-7, pp.575-590, 2010
- [16] Spalart, P., and Allmaras, S., A one-equation turbulence model for aerodynamic flows, 30th Aerospace Sciences Meeting & Exhibit, 1992.
- [17] Langtry, R., and Menter, F., Transition modeling for general CFD applications in aeronautics, 43th Aerospace Sciences Meeting & Exhibit, 2005.
- [18] M. Fioriti, L. Boggero, S. Corpino, A. Isyanov, A. Mirzoyan, R. Lombardi e R. D'Ippolito, «Automated Selection of the Optimal On-board Systems Architecture.» in *18th AIAA/ISSMO Multidisciplinary Analysis and Optimization Conference*, Denver (CO), 2017.
- [19] P. S. Prakasha, P. D. Ciampa, L. Boggero e M. Fioriti, «Assessment of airframe-subsystems synergy on overall aircraft performance in a Collaborative Design.» in *17th AIAA/ISSMO Multidisciplinary Analysis and Optimization Conference*, Washington D.C. (USA), 2016.
- [20] P. S. Prakasha, L. Boggero, M. Fioriti, B. Aigner, P. D. Ciampa, K. Anisimov, A. Savelyev, A. Mirzoyan and A. Isyanov, "Collaborative System of Systems Multidisciplinary Design Optimization for Civil Aircraft:AGILE EU project," in *18th AIAA/ISSMO Multidisciplinary Analysis and Optimization Conference*, Denver, Colorado (USA), 2017.
- [21] D. Rajpal, H. Timmermans, F. Torrigiani, W.F. Lammen , R. De Breuker, "*Including Aeroelastic Tailoring in the Conceptual Design Process of a Composite Strut-Braced Wing*", 31st Congress of the International Council of the Aeronautical Science, 2018
- [22] I. van Gent, G. La Rocca and L. L. Veldhuid, "Composing MDAO symphonies: graph-based generation and manipulation of large multidisciplinary systems," in 18th AIAA/ISSMO Multidisciplinary Analysis and Optimization Conference, Denver, 2017.
- [23] I. van Gent, M. F. M. Hoogreef and G. La Rocca, "CMDOWS: A Proposed New Standard to Formalize and Exchange," in 6th CEAS Air and Space Conference, 2017.
- [24] M. J. Cronin, «All-Electric vs Conventional Aircraft: The Production/Operational Aspects,» *Journal of Aircraft*, vol. 20, n. 6, pp. 481-486, 1983.
- [25] I. Berlowitz, «All/More Electric Aircraft Engine & Airframe Systems Implementation,» in *The 9th Israeli Symposium on Jet Engines and Gas Turbines*, 2010.
- [26] S. Chiesa, S. Corpino, M. Fioriti, A. Rougier e N. Viola, «Zonal safety analysis in aircraft conceptual design: Application to SAve aircraft,» *Proceedings of the Institution of Mechanical Engineers, Part G: Journal of Aerospace Engineering*, vol. 227, n. 4, pp. 714-733 , 2013.
- [27] S. Chiesa, M. Fioriti "UAV Logistic Support Definition" In: Valavanis K., Vachtsevanos G. (eds)

Handbook of Unmanned Aerial Vehicles. Springer, Dordrecht, 2015, https://doi.org/10.1007/978-90-481-9707-1_79.

- [28] S. Chiesa, S. Farfaglia, M. Fioriti e N. Viola, «Design of all electric secondary power system for future advanced medium altitude long endurance unmanned aerial vehicles,» *Proceedings of the Institution of Mechanical Engineers, Part G: Journal of Aerospace Engineering*, vol. 226, n. 10, pp. 1255-1270, 2012.
- [29] Lammering, T., Franz, K., Risse, K., Hoernschemeyer, R., and Stumpf, E., “Aircraft Cost Model for Preliminary Design Synthesis,” 50th AIAA Aerospace Sciences Meeting including the New Horizons Forum and Aerospace Exposition, American Institute of Aeronautics and Astronautics, Nashville, TN, 2012.
- [30] Franz, K., Lammering, T., Risse, K., Anton, E., and Hoernschemeyer, R., “Economics of Laminar Aircraft Considering Off-Design Performance,” 53rd AIAA/ASME/ASCE/AHS/ASC Structures, Structural Dynamics and Materials Conference & 20th AIAA/ASME/AHS Adaptive Structures Conference, American Institute of Aeronautics and Astronautics, Honolulu, HI, 2012.
- [31] Franz, K., Risse, K., and Stumpf, E., “Framework for Sustainability-Driven Aircraft Design,” 2013 Aviation Technology, Integration, and Operations Conference, American Institute of Aeronautics and Astronautics, Los Angeles, CA, 2013.
- [32] AGILE project web-portal, [Online]. Available: <https://www.agile-project.eu/> . [Accessed 27 07 2018].

8 Contact Author Email Address

<mailto:francesco.torrigiani@dlr.de>

Copyright Statement

The authors confirm that they, and/or their company or organization, hold copyright on all of the original material included in this paper. The authors also confirm that they have obtained permission, from the copyright holder of any third party material included in this paper, to publish it as part of their paper. The authors confirm that they give permission, or have obtained permission from the copyright holder of this paper, for the publication and distribution of this paper as part of the ICAS 2018 proceedings or as individual off-prints from the proceedings.