

## Wireless Power Transfer and Optogenetic Stimulation of Freely Moving Rodents

Nassirinia, Farnaz; Straver, Wil; Hoebeek, Freek E.; Serdijn, Wouter A.

**DOI**

[10.1109/NER.2017.8008388](https://doi.org/10.1109/NER.2017.8008388)

**Publication date**

2017

**Document Version**

Accepted author manuscript

**Published in**

Proceedings - 8th International IEEE EMBS Conference on Neural Engineering (NER'17)

**Citation (APA)**

Nassirinia, F., Straver, W., Hoebeek, F. E., & Serdijn, W. A. (2017). Wireless Power Transfer and Optogenetic Stimulation of Freely Moving Rodents. In *Proceedings - 8th International IEEE EMBS Conference on Neural Engineering (NER'17)* (pp. 456-460). IEEE.  
<https://doi.org/10.1109/NER.2017.8008388>

**Important note**

To cite this publication, please use the final published version (if applicable).  
Please check the document version above.

**Copyright**

Other than for strictly personal use, it is not permitted to download, forward or distribute the text or part of it, without the consent of the author(s) and/or copyright holder(s), unless the work is under an open content license such as Creative Commons.

**Takedown policy**

Please contact us and provide details if you believe this document breaches copyrights.  
We will remove access to the work immediately and investigate your claim.

# Wireless Power Transfer and Optogenetic Stimulation of Freely Moving Rodents

Farnaz Nassirinia<sup>1,2,\*</sup>, Wil Straver<sup>2</sup>, Freek E. Hoebeek<sup>1</sup>, and Wouter A. Serdijn<sup>2</sup>

<sup>1</sup>Department of Neuroscience, Erasmus Medical Center, Rotterdam, The Netherlands

<sup>2</sup>Department of Microelectronics, Delft University of Technology, Delft, The Netherlands

\*Corresponding Author: f.nassirinia@erasmusmc.nl

**Abstract**—Animal studies are often used to test the feasibility and effectiveness of neuroscience research ideas. Optogenetics is a state-of-the-art technique that allows researchers to control brain activity with light. Current methods are limited as they use tethered setups with the animal in a fixed position, resulting in stress and reduced animal welfare. Hence, an untethered setup is highly desirable.

We propose a battery-less, wireless optogenetic stimulation setup based on resonant inductive coupling, allowing for full freedom of movement of multiple rodents in a  $40 \times 40 \times 20$  cm environment. Our design includes: a transmitter coil capable of powering the optogenetic stimulation receiver regardless of lateral and vertical misalignments; a  $1 \times 1 \times 1$  cm light-weight head-mounted receiver module with the receiver coil, rectifying and regulating electronics, and a microcontroller; and creation of both rigid and fully-flexible, cost-effective optogenetic optrodes using a novel  $\mu$ LED mounting technique allowing multiple  $\mu$ LEDs to be directly inserted into the brain.

The setup offers a novel and robust solution for freely moving animal studies. The inductive link has a maximum link efficiency of 0.56% at the maximum coupling factor of 0.31%. For an input current of 0.5 A into the primary coil, even for half the peak link efficiency, and an angular misalignment of 45 degrees, the setup can deliver 8.5 mW of light power into the brain.

**Keywords:** Brain Stimulation, Resonant Inductive Coupling,  $\mu$ LEDs, Optogenetics, Optrodes, Wireless Power Transfer

## I. INTRODUCTION

In neuroscience, in-vivo animal research applies a variety of techniques to allow for the stimulation of brain areas, pathways, or combinations of those to explore brain functionality. One such new technique is optogenetic stimulation, a state-of-the-art brain stimulation technique [1]. In optogenetics, genetic techniques are used to introduce light-sensitive ion channels into neuronal membranes that allow for a full, bidirectional control of the neuronal activity using optical stimulation that is inert to non-transfected tissue. Current optogenetic stimulation methods use tethered setups and, typically, the animal-under-study is put into a fixed position. This introduces stress, which, besides an obvious reduction in animal welfare, may also influence the experimental results. Hence, an untethered setup is highly desirable. The untethered setups either make use of batteries or a wireless method of power transfer. The stimulation module resides on the animal and, hence, is restricted in weight and size. Batteries significantly increase the weight and size of the module mounted on the head of the rodents. Therefore, in this study, we propose a wireless optogenetic stimulation

setup that allows for full freedom of movement of multiple rodents-under-study in a  $40 \times 40 \times 20$  cm environment.

Resonant inductive coupling is used as the wireless power transfer method of choice, as this allows for efficient power transfer over a short range and has the least side-effects, making it the most suitable approach for this particular environment [2]. Resonant inductive coupling refers to the wireless transmission of electrical energy from the transmitter coil to the receiver coil. These coils are magnetically coupled and are part of resonant circuits tuned to resonate at the same frequency. The efficiency of inductive coupling is highly susceptible to vertical, lateral and angular misalignment of the coils [3]. The wireless link is, therefore, designed to maximize the link efficiency and minimize the misalignments between the coils. Presently-available wireless stimulation setups do not include a coil design that minimizes the impact of misalignment between the transmitter and the receiver coil [4]. These setups require larger storage elements, such as rechargeable batteries or supercapacitors, in order to store the energy in case of misalignment. These storage elements are heavy and bulky and, hence, add significant weight and size to the head-mounted receiver module [5].

This work introduces wireless power transfer based on resonant inductive coupling, in which, due to the design choices in the shape of the transmitter coil, the inductive link efficiency is not affected by lateral or vertical misalignment. Hence, it provides the ability for running experiments on freely moving rodents in a larger volume. This offers much more freedom when designing experimental structures. For example, it becomes possible to perform experiments where mice are on a running wheel, or to work with larger rodents, which can reach a higher height when standing. This idea is illustrated in Figure 1. The angular misalignment is still able to negatively impact the link efficiency, since when there is an angular misalignment of exactly 90 degrees between the coils, the efficiency of the power transfer drops to zero. However, after observing hours of recorded videos of mice behaviour, we can conclude that the mice head-ring (the implantation site of the receiver box) was almost never perpendicular to the ground.

Moreover, in this paper we propose the design of rigid and fully-flexible optrodes with novel  $\mu$ LED mounting techniques. Commercially-available optogenetic stimulators make use of a high-power LED or laser source that is coupled to fiber optics. The size and weight of the combined LED

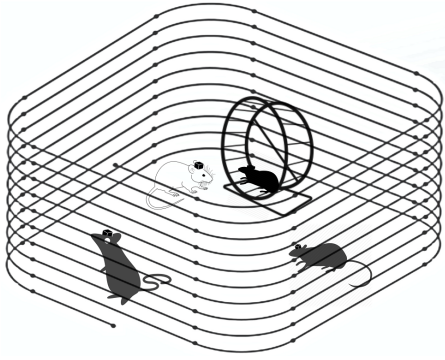

Fig. 1. The wireless cage allows for wireless power transfer from the transmitter coil to the receiver coil that is mounted on the head ring of multiple freely-moving mice.

source and fiber optics makes it undesirable to be wirelessly mounted on the rodent. Hence, this only is used for tethered experiments. Furthermore, the use of these  $\mu$ LED optrodes, which allows for the direct insertion of  $\mu$ LEDs into the brain without the need for optical fibers, greatly improves the power-efficiency, as the traditional LED-to-optical-fiber coupling is accompanied by substantial losses in light intensity. Moreover, a single optrode can harbor several  $\mu$ LEDs and is thereby able to replace a number of optical fibers, resulting in a less-invasive procedure. Furthermore, in optogenetics, emission of light with different wavelengths causes different neural modulation effects. Hence, using multiple  $\mu$ LEDs is also desirable when different stimulation effects are demanded at the same stimulation site. There are publications of different types of implanted  $\mu$ LED arrays that, on the one hand, require elaborate technical procedures and high fabrication costs, and, on the other hand, do not introduce a fully flexible solution for the implant [6], which could be shaped so as to pass through brain structures. Even the most flexible optogenetics optrodes introduced up to now are too stiff to deform into any shape without resisting the deformation. In this paper, we introduce cost-effective  $\mu$ LED optrodes that can be as flexible as a regular 80  $\mu$ m diameter wire. Our setup offers a completely wireless system for optogenetics stimulation of freely moving animals.

## II. IMPLEMENTATION

The implementation of the wireless optogenetics setup consists of three parts: the transmitter cage that provides the power for the wireless setup; the head-mounted module that acts as a wireless power receiver, houses the control module, and converts the power into a usable form for the optogenetics  $\mu$ LEDs; and the optogenetics optrodes that perform the actual optogenetic stimulation.

### A. Transmitter Cage

The transmitter cage's purpose is to provide the rest of the setup with power. A key design feature of the transmitter cage is the fact the transmitter coil completely encompasses the area in which the animals are allowed to roam freely. Hence, this coil is completely wrapped around a transparent box made of PolyMethylMethAcrylate (PMMA). High Frequency Electromagnetic Field Simulation Software (HFSS)

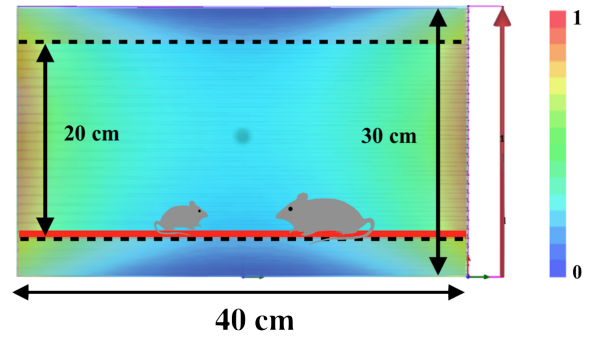

Fig. 2. Magnetic field generated by the transmitter coil, as simulated in HFSS. The field is strongest near the edges of the coil (left and right side in the figure), and weakest on the top and bottom. Therefore, although the height of the coil is 30 cm, the effective height is restricted to 20 cm.

has been used to accurately simulate the generated magnetic field (see Figure 2), and to bring the coil at resonance. Operating at the resonance frequency is important as this allows for maximum efficiency in wireless power transfer [7]. The parameters under our control are: the wire diameter, the coil width, the pitch, and the number of turns  $N$ . The transmitter coil design is finalized with the specifications as listed in Table I, so as to resonate at a frequency of 13.56 MHz and has an equivalent impedance of 50  $\Omega$ .

The second key design aspect of the coil is to provide sufficient effective space where enough power can be provided for optogenetic stimulation. The effective space is that particular volume within the transmitter coil that has an almost uniform magnetic field, so that the lateral and vertical misalignment between the transmitter and the receiver coil do not dramatically affect the inductive link efficiency. The effective area is an area of 40 $\times$ 40 cm within the PMMA box. The effective height of the cage is 20 cm, as the magnetic field at top 5 cm and the bottom 5 cm is of lower strength (again, see Figure 2). Hence, the effective space is 40 $\times$ 40 $\times$ 20 cm, in which the resonant inductive link allows powering the optogenetic stimulation receiver with only limited impact of lateral and vertical misalignment.

TABLE I  
TRANSMITTER COIL PARAMETERS

$N$	Wire Radius	Coil Width	Pitch	$L$	$Q$	$S_{11}$
30	0.5 mm	400 mm	1 mm	367 $\mu$ H	113	-20 dB

### B. Receiver Module

The purpose of the receiver module is to act as a receiver for the wireless power supplied by the transmitter cage, and to house all components required for optogenetic stimulation. As it resides on the head of the animal, it is severely restricted in both size and weight. The circuit schematic of the receiver module components is shown in Figure 3. The combined function of these electronics is to guarantee a stable power supply to the optrodes. For the assembly of the head-mounted module, a cross-shaped PCB is designed (Figure 4a). The PCB offers twice the area required, reserving space for a future project that will allow for wireless

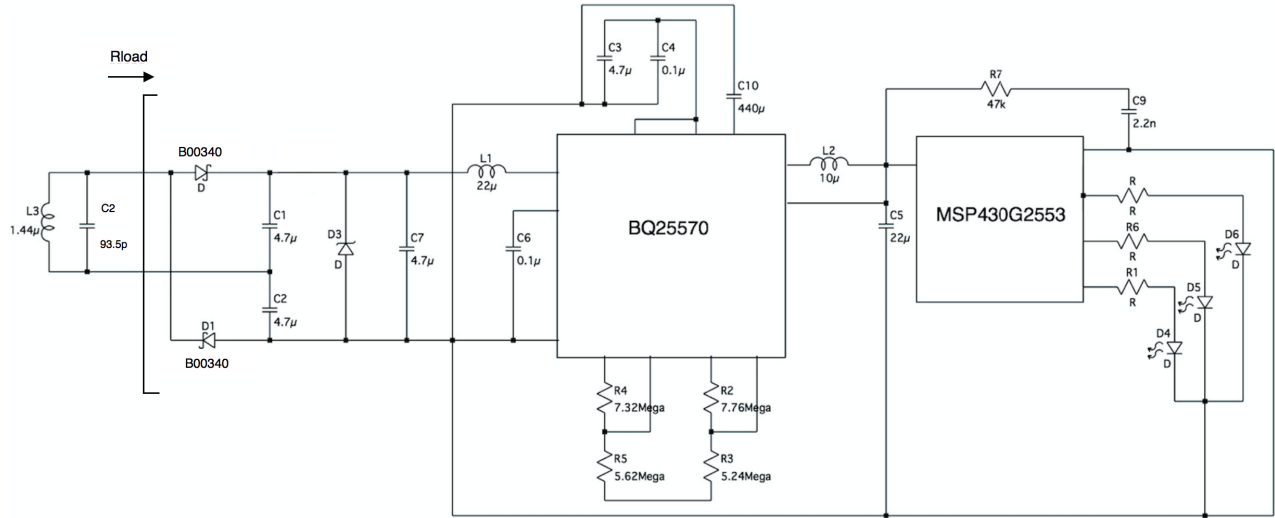

Fig. 3. Receiver module circuit schematic.  $R_{load}$  is the load as seen by the resonator at the input of the rectifier.

recording of ECoG signals. The PCB is further folded into a cube of  $1 \text{ cm}^3$ , which acts as the platform for winding the coil (Figure 4b and 4c). The complete module weighs less than one gram. The key components are:

**Controller Module:** To implement the control module, we make use of a Texas Instruments MSP430G2553 microcontroller, which is intended for use in ultra-low-power applications. This MCU is capable of providing 5 mA at a high-level output voltage of 2.75 V, for an input voltage of 3 V. This is sufficient to power the optogenetics optrodes used to achieve neural modulation through optogenetics. Hence, to avoid the use of extra components, such as switches, we directly connect the MCU to the optogenetics optrodes. The MCU is programmed to provide the stimulation pattern, as well as the stimulation intensity through the use of Pulse Width Modulation. The MCU is programmed in such a way as to place the microcontroller into a low-power mode as often as possible. Hence, the waiting routines are implemented using hardware counters, during which the CPU itself is put into a low-power state.

**DC-DC Converter:** In order to regulate the DC voltage, to store the energy when a surplus is available, and to match the voltage-to-current ratio of the input power to the level that is required by the storage element, an ultra-low-power boost charger and buck converter device, the BQ25570, together with an super capacitor of  $440 \mu\text{F}$  is utilised.

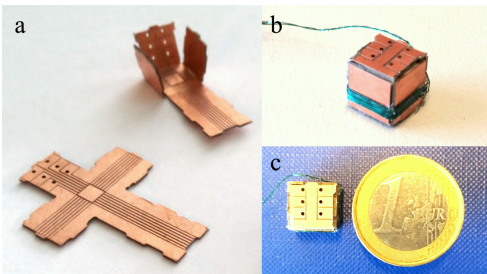

Fig. 4. a) Receiver cross-shape PCB. b) PCB housing the stimulation electronics folded into a box of  $1 \text{ cm}^3$ . The receiver coil is wrapped around the box. c) The receiver module size as compared to a one Euro coin.

**Rectifier:** The efficiency of the BQ25570 increases with higher DC voltage. Hence, we choose for a full-wave rectifier with voltage doubling using Schottky diodes B00340.

**Receiver Coil:** The dielectric constant of the medium outside the coil varies, based on the location of the receiver, for example by being close to the transmitter windings, or near another mouse's receiver. The coil's internal dielectric constant also varies with different assemblies of the electronics inside the coil. These variations change the parasitic capacitance of the coil and, therefore, affect the resonance frequency. For this reason, we ensure that the parasitic capacitance is not dominant, through resonating the receiver coil with a parallel capacitance  $C_2$  that is at least a hundred times larger than the coil stray capacitance. This way, the coil resonates at 13.56 MHz, which is at least ten times lower than its self-resonance frequency. This represents a trade-off between lower voltage gain and the addition of an extra component, and a more reliable resonator. The receiver coil is a rectangular solenoid coil, which is wound on the folded receiver PCB box. Table II includes the coil's specifications.

TABLE II  
RECEIVER COIL PARAMETERS

N	Wire Radius	Coil Width	Pitch	L	$C_2$	Q
11	0.11 mm	10 mm	0.4 mm	$1.44 \mu\text{H}$	93.5 pF	21

### C. Optogenetics Optrodes

In a conventional setup, usually, at the coupling between the LED or laser and the optical fiber, large amounts of light power are lost, in effect requiring a much larger power supply. In the case of animal experiments using tethered rodents, the animals are at fixed positions and, therefore, a higher power consumption is not very problematic. However, when using a wireless system that relies on wireless power transfer, power consumption becomes critical. Therefore, the key idea here is to use lower-cost platforms to mount the LEDs on. Using Cree Semiconductors Razer Thin Gen III CxxxUTyyy bare dies of  $\mu\text{LEDs}$ , two main ideas have been explored and developed:

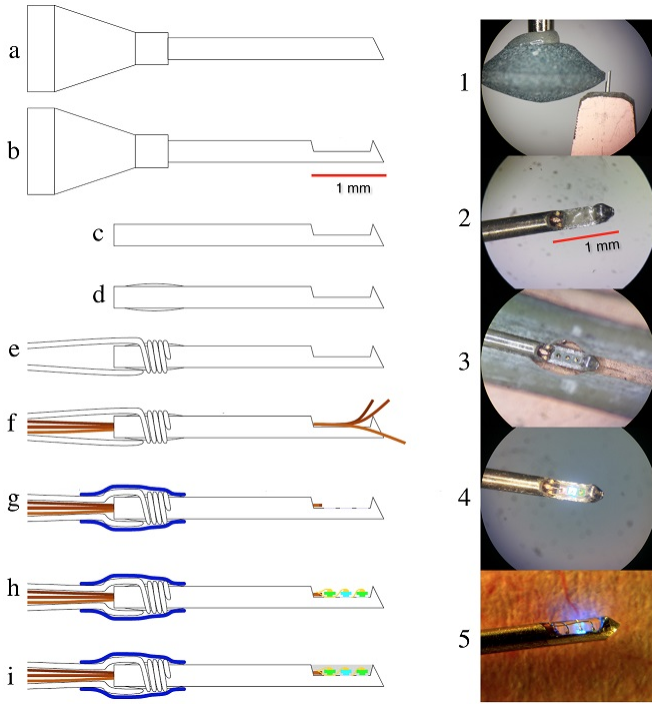

Fig. 5. Needle optrode fabrication steps: a) and b) Shape the edge of the needle to a flatter surface using the scrub roller machine (image 1). c) Remove the plastic connector. d) Remove the isolation from the end of the wire and edge button of the needle. Apply conductive silver glue to the needle. e) Wrap the other end around the back-end of the needle and heat it up. f) Insert one, two or three anode wires through the needle cavity. The wires are fixed in position and the isolation of the middle part of the wire is removed. The needle tube is filled with non-conducting fast curing glue. g) Apply integrated circuit silver paste on the flatten surface (image 2). h) Place the  $\mu$ LEDs on the paste using the pick-and-place machine (image 3), heating up the needle. Perform gold bonding on the  $\mu$ LEDs using a bonding machine (image 4). i) Cover the  $\mu$ LEDs with the fast UV-curing optic glue (image 5) and fix the plastic end to the wires by using heat-shrink tubes.

**Rigid Optrodes:** Using injection needles as a platform for mounting the LEDs, instead of micro-machined printed circuit boards. These needles are the conventional injection needles that are available in different gauges in medical facilities. Refer to Figure 5 for the design steps. The  $\mu$ LEDs have a common ground terminal. The needle body in this configuration provides the ground for the  $\mu$ LEDs. The anode wires are isolated wires, which pass through the needle cavity. Each extra  $\mu$ LED in the array increases the length of the optrode. If the additional  $\mu$ LED is individually controllable, then it requires its own anode wire through the needle cavity.

**Fully-Flexible Optrodes:** The most flexible platform for the implant is one that is as flexible as its connecting wire. This thought initiated the design of the flexible implants, which consist of  $\mu$ LEDs and wires only. The main idea is to use different size wires as a platform for mounting the  $\mu$ LEDs, and to bond them. A thicker wire by itself then acts as a wide platform for smaller modules. See Figure 6 for the design steps. As compared to the needle optrodes, the needle body is omitted. Hence, no ground plate is available. Therefore,  $\mu$ LEDs with the same packaging, but opposite polarities are used. In this configuration, the  $\mu$ LEDs are placed in a mirrored fashion, where the anode of one  $\mu$ LED

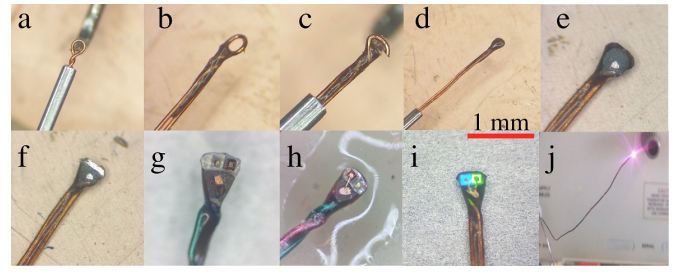

Fig. 6. Fully-flexible optrode fabrication procedure: a) A tiny loop of wire ( $80 \mu\text{m}$ ,  $100 \mu\text{m}$ , or  $160 \mu\text{m}$  in diameter), twist the wire ends. b) Apply a micro-drop of two-component glue on the twisted knot. c) Cut the loop open near the lower wire and shape it flat. d) Cover the open loop with two-component glue. e) and f) Cut pieces of glue and wire isolation in two steps. Here we create a copper dot and a copper line. g) Mount the bare dies of  $\mu$ LED on the copper line. h) Gold-bond the  $\mu$ LEDs gold plate to the copper dot. i) Test the  $\mu$ LEDs blinking and cover the top of the optrode with UV-curing glue. j) Fully-flexible optogenetics optrode.

faces the cathode of the other and vice versa.

Both rigid and flexible optrodes are proven to be waterproof and mechanically strong by testing them in water and gelatin, while at the same time running a long duration stimulation program on a nano-Arduino.

### III. RESULTS

The power efficiency of the entire wireless system depends on the inductive link efficiency  $\eta_{link}$  and on the line efficiency  $\eta_{line}$ . These are defined as follows:

$$\eta_{link} = \frac{P_{\text{delivered to } R_{load}}}{P_{\text{delivered to primary coil}}}, \quad \eta_{line} = \frac{P_{\text{delivered to } \mu\text{LEDs}}}{P_{\text{delivered to } R_{load}}}$$

The maximum coupling factor between the transmitter and the receiver coil equals 0.31%. The inductive link efficiency  $\eta_{link}$  at a fixed coupling factor of 0.31% is shown in Figure 7. The link efficiency depends on the load,  $R_{load}$ , as seen by the resonator at the input of the rectifier [7]. For an  $R_{load}$  of  $430 \Omega$  to  $14.4 \text{ k}\Omega$ , the link efficiency is above 0.28%, which is half of the peak efficiency. The power efficiency further decreases due to the losses in the rectifier, in the regulator, and in the microcontroller. Figure 8 includes the measurement results for the line efficiency for each of these blocks for varying input power, as well as the total line efficiency  $\eta_{line}$ . We observe that for an input power above 2 mW, the line efficiency is above 50%.

On the one hand, there was no effect of lateral and vertical misalignment observed on the link efficiency. This is as expected, since the transmitter coil has been designed to be able to provide an area of  $40 \times 40 \times 20 \text{ cm}$  with low impact of the vertical and lateral misalignment. On the other hand, the angular misalignment between the transmitter and receiver coil has an obvious effect on the inductive link efficiency, as can be seen in the measurements shown in Figure 9. Only a limited number of angles has been measured, and for certain angles, it was hard to fix the receiver at that exact angle. These are shown by a line interval in the figure. Hence, we can conclude that the angular misalignment is the only misalignment that has a major effect on the link efficiency. This effect is notated as angular efficiency  $\eta_{\theta}$ .



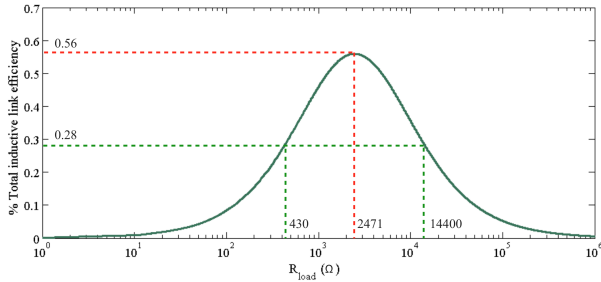

Fig. 7. Effect of  $R_{load}$  on inductive link efficiency  $\eta_{link}$  at a fixed coupling factor of 0.31%. The lower horizontal line (green) indicates the load at which half of the peak efficiency is provided.

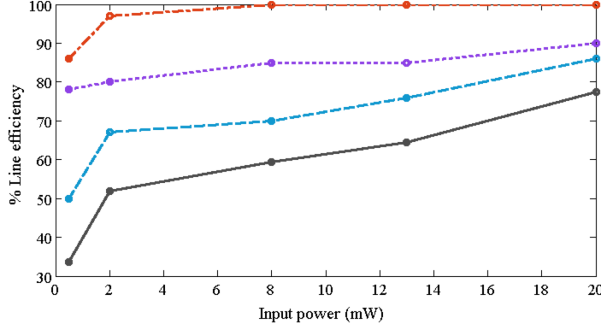

Fig. 8. Line efficiency  $\eta_{line}$  versus input power. From highest to lowest efficiency: MCU efficiency (dashed+dots), regulator efficiency (dots), rectifier efficiency (dashed), and total line efficiency (straight line).

Then, the inductive link efficiency for any  $R_{load}$  at any position and orientation of the receiver coil equals:

$$\eta_{total} = \eta_{link} \times \eta_{line} \times \eta_{\theta}$$

Applying a current of 0.5 A into the transmitter coil and considering an average angular misalignment of 45 degrees, the setup is able to provide 8 mW of light power into the brain. An increase in power to the transmitter coil results in an increase in the EM field, as the magnetic field strength  $H$  of a coil is directly proportional to the input current through the coil. Figure 10 demonstrates the magnetic field strength  $H$  for different input currents along the axis of the transmitter coil. The figure shows that even for an input current of 10 A, the magnetic field strength is below what would be considered harmful to rodents, for example by driving neural activity [8].

#### IV. CONCLUSION

To overcome the drawbacks that a tethered neurological research setup suffers from, such as limiting the types of studies that can be performed and reduced animal welfare, we have designed a wireless powered optogenetic stimulation setup for freely moving rodents that offers stimulation within a volume of  $40 \times 40 \times 20$  cm.

The complete wireless power harvesting system offers a number of novel features, including: a transmitter cage that offers wireless power transmission that is relatively independent of lateral and vertical misalignment; a head-mounted receiver module based on a folded PCB that weighs below one gram and is only  $1 \text{ cm}^3$ ; and state-of-the-art implantable optogenetics optrodes that are either rigid or flexible, and

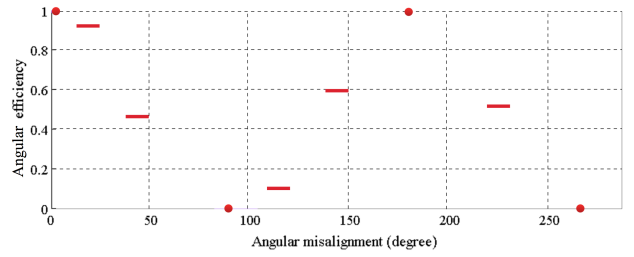

Fig. 9. Measurement results of angular efficiency  $\eta_{\theta}$  for different degrees of angular misalignment between the receiver and the transmitter coil.

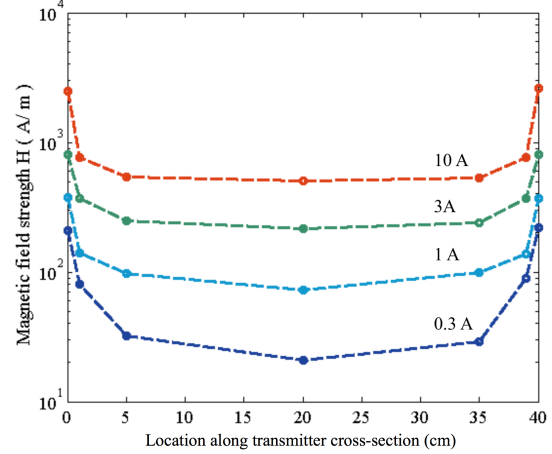

Fig. 10. Magnetic field strength  $H$  (A/m) within the transmitter coil box, along the cross-section of the transmitter cage, for different RMS (root mean square) values of current (A) fed into the transmitter.

cost-effective. The overall efficiency of the inductive link can reach 0.56% at a coupling factor of 0.31%. This allows for an optogenetics stimulation of 8 mW when 0.5 A is fed into the transmitter coil at an angular misalignment of 45 degrees. Our wireless setup greatly expands the design space for animal experiments, improving upon the range of feasible optogenetic stimulation studies.

#### REFERENCES

- [1] E. S. Boyden, F. Zhang, E. Bamberg, G. Nagel, and K. Deisseroth, "Millisecond-timescale, genetically targeted optical control of neural activity," *Nature neuroscience*, vol. 8, no. 9, pp. 1263–1268, 2005.
- [2] F. Nassirinia, "Wireless power transfer and optogenetic stimulation of freely moving rodents," Master's thesis, TU Delft, 2016.
- [3] K. Fotopoulou and B. W. Flynn, "Wireless power transfer in loosely coupled links: Coil misalignment model," *IEEE Transactions on Magnetics*, vol. 47, no. 2, pp. 416–430, 2011.
- [4] C. T. Wentz, J. G. Bernstein, P. Monahan, A. Guerra, A. Rodriguez, and E. S. Boyden, "A wirelessly powered and controlled device for optical neural control of freely-behaving animals," *Journal of neural engineering*, vol. 8, no. 4, p. 046021, 2011.
- [5] M. A. Rossi, V. Go, T. Murphy, Q. Fu, J. Morizio, and H. H. Yin, "A wirelessly controlled implantable LED system for deep brain optogenetic stimulation," *Frontiers in integrative neuroscience*, vol. 9, p. 8, 2015.
- [6] J. G. McCall, T.-i. Kim, G. Shin, X. Huang, Y. H. Jung, R. Al-Hasani, F. G. Omenetto, M. R. Bruchas, and J. A. Rogers, "Fabrication and application of flexible, multimodal light-emitting devices for wireless optogenetics," *Nature protocols*, vol. 8, no. 12, pp. 2413–2428, 2013.
- [7] K. Van Schuylenbergh and R. Puers, *Inductive powering: basic theory and application to biomedical systems*. Springer Science & Business Media, 2009.
- [8] T. Radman, R. L. Ramos, J. C. Brumberg, and M. Bikson, "Role of cortical cell type and morphology in subthreshold and suprathreshold uniform electric field stimulation in vitro," *Brain stimulation*, vol. 2, no. 4, pp. 215–228, 2009.