

Innovative approach toward an algorithm for automated defect recognition for on-load-tap changers

Riaz, Fahim; Wetzer, Jos; Mor, Armando Rodrigo

DOI

[10.1049/oap-cired.2017.0326](https://doi.org/10.1049/oap-cired.2017.0326)

Publication date

2017

Document Version

Final published version

Published in

CIREN - Open Access Proceedings Journal

Citation (APA)

Riaz, F., Wetzer, J., & Mor, A. R. (2017). Innovative approach toward an algorithm for automated defect recognition for on-load-tap changers. *CIREN - Open Access Proceedings Journal*, 2017(1), 246-250. <https://doi.org/10.1049/oap-cired.2017.0326>

Important note

To cite this publication, please use the final published version (if applicable). Please check the document version above.

Copyright

Other than for strictly personal use, it is not permitted to download, forward or distribute the text or part of it, without the consent of the author(s) and/or copyright holder(s), unless the work is under an open content license such as Creative Commons.

Takedown policy

Please contact us and provide details if you believe this document breaches copyrights. We will remove access to the work immediately and investigate your claim.

Innovative approach toward an algorithm for automated defect recognition for on-load-tap changers

Fahim Riaz¹ ✉, Jos Wetzer¹, Armando Rodrigo Mor²

¹Asset Management, DNV GL Energy, Arnhem, The Netherlands

²Electrical Sustainable Energy, TU Delft, Delft, The Netherlands

✉ E-mail: Fahim.Riaz@dnvgl.com

Abstract: Power transformers are valuable assets in the power network, with the primary function to regulate the transmission and distribution voltage. The regulating device is the tap changer which sets the turn ratio. Tap changer failure is one of the leading causes of high-voltage power transformer failure. Most tap changer failures are caused by degrading contacts. Contact degradation may be the result of contact wear or of arcing-induced carbon deposition during on-load-tap (OLT) changes. Contact degradation increases contact resistance, causing increased heating and arcing, eventually leading to possible failure of the power transformer. Proper maintenance, therefore, requires a diagnostic system which can assess the condition of the contacts. The research presented is aiming at automated defect recognition and localisation from measured dynamic resistance measurement patterns, for two types of tap changers, the 'Diverter Switch' type and the 'Selector Switch' type OLT changer.

1 Introduction

Power transformers are among the most valuable assets of the power network system. A large amount of capital is required to manufacture, transport, install and maintain them. Power transformers are used to transform the voltage levels for transmission and distribution, and are vital for the power system. As the load in the network changes, the voltage is affected and needs to be regulated. Voltage regulation is performed by on-load-tap changers (OLTCs). Maintaining a proper voltage level is important for several reasons:

- To limit the losses.
- To maintain synchronisation within the network.

The only moveable part present in the power transformer is the tap changer. The placement of tap changer is illustrated in Fig. 1 [1]. The purpose of the tap changer is to change the turns ratio. Tap changer failure is one of the leading causes of failure of power transformers. Per [2, 3] more than 40% of the failures of high-voltage (HV) power transformers are caused by the OLTC. The switching of current from one tap position to other tap position can result in heating and arcing. This can cause contact degradation and may ultimately lead to failure of the power transformer. The general life time of a power transformer ranges from 40 to 50 years, and a diagnostic system [the dynamic resistance measurement (DRM)] is used to judge the condition of the contacts during its life. The goal of the work presented is to arrive at an automatic interpretation system that can identify and locate the faulty contact based on the information received from the DRM.

1.1 Types of OLTCs

There are several OLT changing mechanisms. The focus of this research is on two of the tap changing mechanisms.

1.1.1 Selector switch type: The simplified configuration of this type of tap changer is shown in Fig. 2 [4]. This type of OLTC makes fine tap selection and switches the load current at the same time

while the coarse tap selector switches to the next contact without current flowing through it.

1.1.2 Diverter switch type: The simplified configuration of this type of tap changer is shown in Fig. 3 [4]. This type of OLTC first selects the next fine tap position and then switches the load current to it. The coarse tap selector always switches to the next contact without current flowing through it.

2 Dynamic RM

DRM is an off-line technique to examine the condition of the contacts of the OLTC. The technique is not as accurate as static resistance measurement but provides more relevant information and takes far less time. Temperature adjustment is applied when comparing the data with previous records. Fig. 4 [4] shows the circuit and terminal connections for performing DRM.

2.1 Method

The measuring technique uses a DC power supply to introduce a current in the tap changer circuit as shown in Fig. 4. After disconnecting the transformer, the secondary side of the transformer is short circuited. The primary side is series connected to a 'known' resistor (R_1), a measuring resistor and a DC power supply. The known resistor has a bypass switch which is usually closed. After each transition, the bypass switch is opened during a certain period (manually selected, usually around 1 s) and thereby the known resistor becomes part of the circuit. This sequence is performed for each of the tap changer contacts, and repeated until for each phase a total of four series is performed. For each series, the current is recorded providing a record as shown in Fig. 5 [4] (for one tap position) and Fig. 6 [5] (for all tap positions). From the DRM record, the resistance at each tap position is calculated, yielding a resistance graph as shown in Fig. 7 [5]. Four measurements series are performed:

- Measurement 1: current setting 1, from first to last tap.
- Measurement 2: current setting 1, from last to first tap.

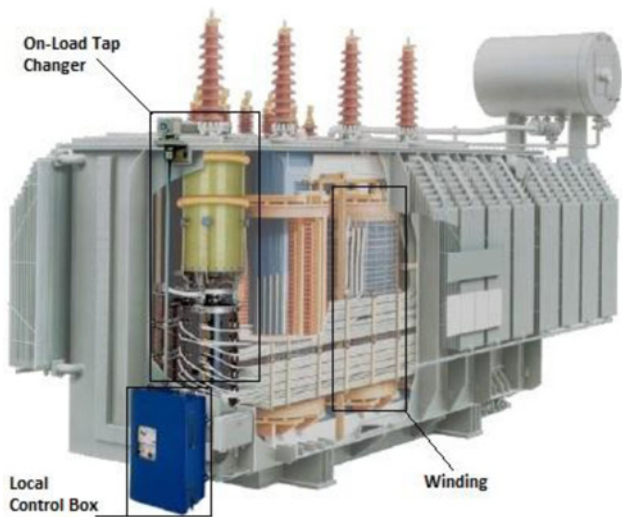

Fig. 1 Artistic image showing internal section of HV power transformer with tap changer location

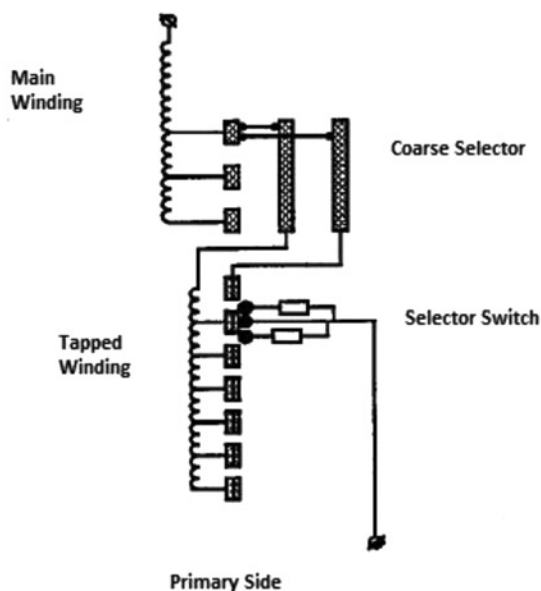

Fig. 2 Simplified depiction of selector switch type tap changing mechanism

- Measurement 3: current setting 2, from first to last tap.
- Measurement 4: current setting 2, from last to first tap.

The reason for varying the current is because of the thickness of the oil layer that develops on the contacts after some time of operation. The reason for performing two measurements at the same test current in opposite directions is to account for the mechanical positioning of the contact at which it rests after its transition. Once all measurements are performed, the resistance at each tap position is calculated. This results in 4 DRM records and 4 resistance graphs for each phase, hence a total of 12 DRM records and 12 resistance graphs.

2.2 Resistance measurement principles

The resistance values are calculated from the DRM records. The circuit that results provides the DRM records and is connected on the primary side while the secondary side of the transformer is short circuited. The resistance value measured at the primary side is influenced by the secondary resistance [5]. Therefore, the value

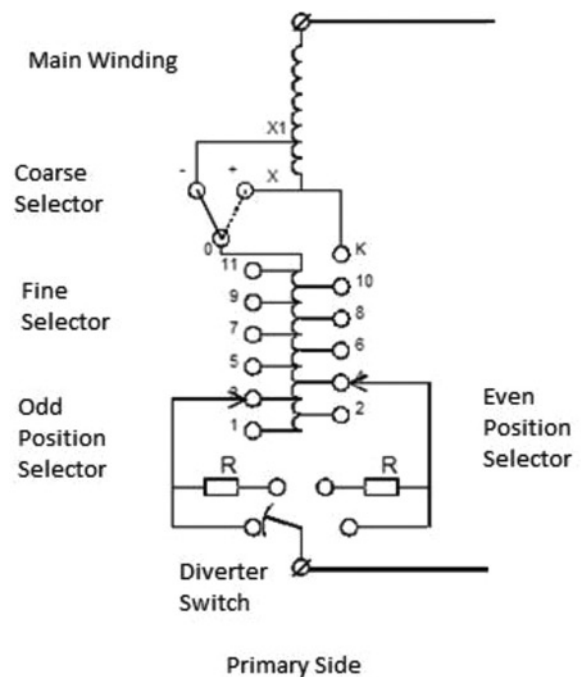

Fig. 3 Simplified depiction of diverter switch type tap changing mechanism

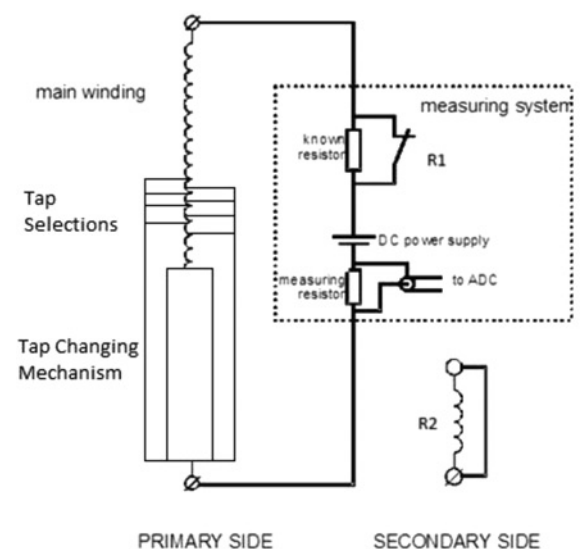

Fig. 4 Measuring set-up

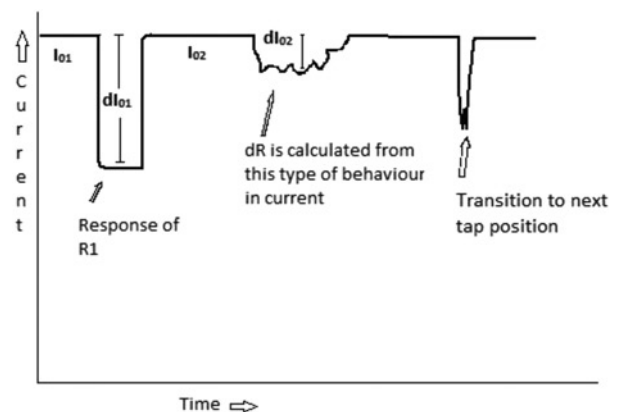

Fig. 5 Schematic current record of one tap position

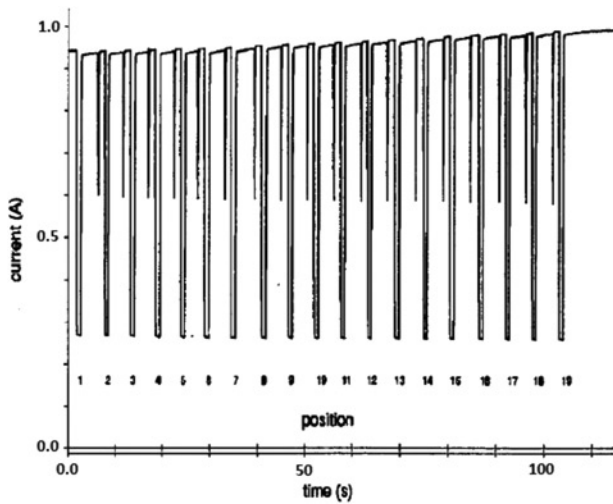

Fig. 6 Recorded current during measurement (DRM record)

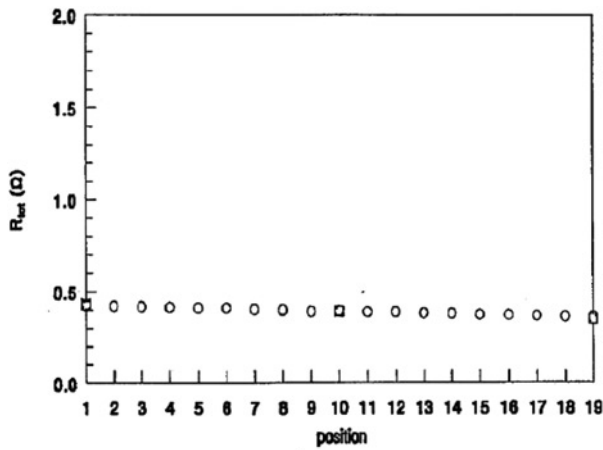

Fig. 7 Calculated resistance at each tap position obtained from DRM records (resistance graph)

of the secondary resistance should be known. Directly after switching on the current on the primary side, the measured resistance equals

$$R_{\text{tot}} = \frac{U_0}{I_0(0)} - N^2 R_2$$

After the current, has stabilised, the resistance equals

$$R_{\text{tot}} = \frac{U_0}{I_0(\infty)}$$

$$R_2 = \frac{1}{N^2} \left(\frac{U_0}{I_0(0)} - R_{\text{tot}} \right)$$

Once the secondary resistance is derived, the known resistor can be used to derive the total resistance R_{tot} . The basic purpose of the known resistor is to help in calculating the total resistance, without having to wait for the current to stabilise [5]. The known resistance is switched in series after the tap changer has established a contact at a given tap position. With the known resistance inserted, the circuit time constant decreases and the current quickly stabilises. The total resistance value is calculated

using the below formula. The current values used in these formulas are also indicated in Fig. 5

$$R_{\text{tot}} = - \frac{R_1(I_{01} + dI_{01}) + dI_{01}N^2R_2}{dI_{01}}$$

Here, R_{tot} is the total resistance at the primary side at a specific tap position, R_2 is the resistance of the secondary winding, N is the turns ratio, U_0 and I_0 are the primary voltage and current, R_1 is the known resistance usually chosen such that the current drops by about 50%, I_{01} is the value of the current before the known resistance was brought into series and dI_{01} is the change of current (a negative value)

2.2.1 Contact resistance: The total resistance at the primary side consists of the summation of:

- the value of the measuring resistor,
- the secondary resistance as seen from the primary side,
- the resistance of the connecting cables,
- the winding resistance and
- the contact resistance.

$$R_{\text{tot}} = R_{\text{measure}} + N^2 R_2 + R_{\text{cable}} + R_w + R_{\text{contact}}$$

As R_{measure} , N , R_2 and R_{cable} are known, the total resistance allows to derive the sum of R_w and R_{contact} . In case the contact resistance is virtually zero (which is the case for healthy contacts [4]), we may derive the winding resistance from the measured total resistance.

2.2.2 Dynamic contact resistance (dR): The contacts of the tap changers are originally clean and smooth, so when they move against one another there is no increase in contact resistance. After many operations, carbon is deposited on the contacts, resulting in an increase in contact resistance as shown in Fig. 5. Thus, the measured resistance will deviate from the overall resistance previously termed as R_{tot} . As per [5], the value of increased resistance due to carbon deposits and unsmooth contacts is derived from

$$dR = \frac{dI_{02}(R_{\text{tot}} + N^2 R_2)}{I_{02} + dI_{02}}$$

2.3 Transition time

The time taken by the contacts of the tap changer to completely transfer the current to the next tap position [4] is shown in Fig. 8.

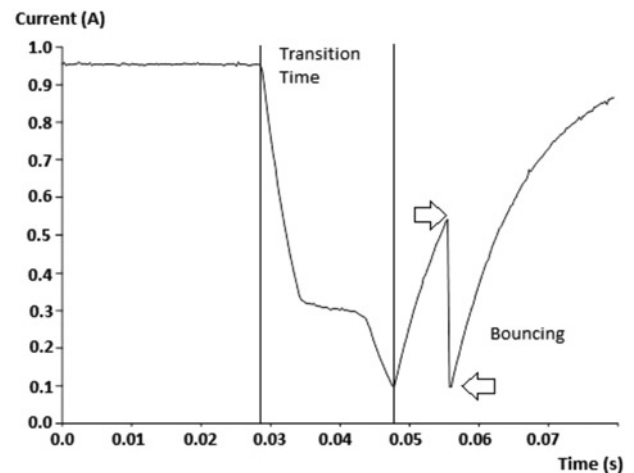

Fig. 8 Behaviour of current during the transition

3 Fault indicators

The fault indicators are derived from the DRM records. These indicators shall provide the basis to identify the faulty contacts.

3.1 Contact resistance

If the contact resistance is increased, it is important to know the location of the OLTC contacts with increased contact resistance.

3.1.1 Fine or coarse tap position: If the contact resistance is increased on a fine tap selection contact, the deviation is only seen at that specific position. If it is increased on a coarse tap selector contact, the deviation is observed on all fine tap positions connected to that coarse tap selector.

3.2 Dynamic contact resistance

The dynamic contact resistance is observed while the contacts are moving or if insufficient pressure on the contacts causes them to vibrate.

3.2.1 Fine or coarse tap position: If a dynamic contact resistance is observed during contact movement, it is important to know whether this involves the coarse tap selector or the fine tap selector. If a DR is caused by insufficient pressure, it appears on all tap positions and possibly even when the contacts are at a steady position.

3.3 Transitioning spring

The motor winds the spring to accumulate the energy which is then released during the transition to next fine tap position [6]. The time taken by spring to release the energy is an indicator which can be compared with the information provided by the manufacturer. In some cases, the contacts involved in transition, bounce as shown in Fig. 8. If the current drops to zero during more than 5 ms during bouncing, then it is termed undesirable.

4 Algorithm

The algorithm uses the fault indicators presented to identify the type and location of fault. The transition times and markers when known resistor is switched in is provided to the algorithm as input.

4.1 Condition indicator and levels

In this paragraph, we propose a common indicator that provides information about the condition of the OLTC. The condition indicator involves the following three factors:

- the maximum resistance difference between the phases as derived from measurements 3 and 4,
- (R_{w_max}) ,
- the maximum dynamic contact resistance as derived from measurements 3 and 4 (dR_{max}),
- the degradation factor obtained from the dynamic contact resistance (dR_{factor}). The DR is calculated for each tap position. We select the value with the highest degradation factor and use it to derive the condition indicator. The degradation factor can be calculated at each tap position by using the formula

$$dR_{factor} = \frac{(dR_{max}^2)}{dR_{min}}$$

Here, dR_{max} is the maximum value of dR obtained from measurement 3 or 4, dR_{min} is the minimum value of dR obtained from measurement 1 or 2.

Table 1 Levels defined for the proposed condition indicator

Condition	Condition indicator, mΩ	
	Diverter switch	Selector switch
good	0–20	0–100
suspicious	20–400	100–250
bad	>400	>250

Finally, the condition indicator is derived from

$$\text{condition indicator} = R_{w_max} + dR_{max} + dR_{factor}$$

Table 1 shows the proposed condition indicator criteria.

4.1.1 Three-phase resistance match: The transformers are manufactured such that each tap position has an equal number of turns and thereby an equal resistance. If all the tap positions have equal resistances, the OLTC is in healthy condition from this perspective.

4.2 Reference resistance

The algorithm uses the value of the resistance and calculates the percent increase with respect to a reference value:

- At any tap position where the resistance values of three phases match, this value is used as reference value.
- If no position is found where R_w matches for all three phases, then the following method is used as an approximation: at each tap position, the maximum difference of resistance between phases is derived. We select the pair of phases with the highest resistance difference, and choose the lower resistance value as the reference.

The proposed criteria for judging the relative and absolute contact resistance changes are presented in Tables 2 and 3.

4.3 Transitioning spring

The transition times are compared with previous records or with details provided by the manufacturer. They are also checked for bouncing duration.

4.4 Interpretation steps

- The value of the condition indicator answers the question whether the transformer is suitable for service.
- The amount of contact resistance changes as derived from Tables 2 and 3 are used to locate the fault. It shows whether the

Table 2 Relative levels proposed for contact resistance change

Percent change, %	Termed ageing
0–5	healthy
5–10	light
10–20	medium
+20	advance

Table 3 Absolute levels proposed for contact resistance change

dR value, mΩ	Termed ageing
0–5	healthy
5–10	light
10–15	medium
+15	advance

fault is at the coarse tap selector or at the fine tap selector, and identifies the faulty contact.

- If bouncing is detected, it is notified in the algorithm output.

5 Conclusion and future work

As a proof-of-principle, the algorithm output of DRM interpretation of about ten transformers is compared with the result of expert judgement. It is concluded that it is very well possible to perform an automated analysis on DRM data. As a next step, the algorithm will be applied to many more measured patterns and improve the statistical significance of the results. On the basis of the results a specific set of instructions and criteria will be coded that can serve as a fully automated defect recognition algorithm.

6 References

- 1 Seltsam, U.: 'Design, function and operation of on-load tap-changers' (Maschinenfabrik Reinhausen GmbH, Regensburg, Germany, 2013)
- 2 Erbrink, J.J.: 'Experimental model of aging mechanisms of on-load tap changer contacts'. Proc. Int. Conf. Condition Monitoring and Diagnosis, Beijing, China, 2008
- 3 Erbrink, J.J.: 'Experimental model for diagnosing on-load tap changer contact aging with dynamic resistance measurements'. Proc. 20th Int. Conf. Electricity Distribution, Prague, Czech Republic, 2009
- 4 Verhaart, H.: 'Manual for the KEMA off-line tap changer diagnostics' (KEMA Nederland B.V., Arnhem, The Netherlands, 2008)
- 5 Verhaart, H.: 'A diagnostic to determine the condition of the contacts of the tap changer in a power transformer'. Proc. Int. Conf. Electricity Distribution (CIRED), Brussels, Belgium, 1995
- 6 Ryan, H. M.: 'High voltage engineering and testing' (The Institution of Electrical Engineers, London, UK, 2001)