



Delft University of Technology

**Proceedings of the PowerSkin Conference
January 19th 2017, Munich**

Auer, Thomas; Knaack, Ulrich; Schneider, Jens

Publication date
2017

Document Version
Final published version

Citation (APA)
Auer, T., Knaack, U., & Schneider, J. (Eds.) (2017). *Proceedings of the PowerSkin Conference: January 19th 2017, Munich*. TU Delft OPEN Publishing.

Important note
To cite this publication, please use the final published version (if applicable).
Please check the document version above.

Copyright
Other than for strictly personal use, it is not permitted to download, forward or distribute the text or part of it, without the consent of the author(s) and/or copyright holder(s), unless the work is under an open content license such as Creative Commons.

Takedown policy
Please contact us and provide details if you believe this document breaches copyrights.
We will remove access to the work immediately and investigate your claim.

*This work is downloaded from Delft University of Technology.
For technical reasons the number of authors shown on this cover page is limited to a maximum of 10.*

JANUARY 19TH 2017 – MUNICH

POWERSKIN CONFERENCE

PROCEEDINGS

JANUARY 19TH 2017 – MUNICH

POWERSKIN CONFERENCE

PROCEEDINGS

JANUARY 19TH 2017 – MUNICH

POWERSKIN CONFERENCE

The Building Skin has evolved enormously over the past decades. Energy performance and environmental quality of buildings are significantly determined by the building envelope. The façade has experienced a change in its role as an adaptive climate control system that leverages the synergies between form, material, mechanical and energy systems in an integrated design.

The PowerSkin Conference aims to address the role of building skins to accomplish a carbon neutral building stock. Topics such as building operation, embodied energy, energy generation and storage in context of façades, structure and environment are considered.

Three main themes will be showcased in presentations of recent scientific research and developments as well as projects related to building skins from the perspectives of material, technology and design:

Environment – Façades or elements of façades which aim for the provision of highly comfortable surroundings where environmental control strategies as well as energy generation and/or storage are integral part of an active skin.

Façade Design – The building envelope as an interface for the interaction between indoor and outdoor environment. This topic is focused on function and energy performance, technical development and material properties.

Façade Engineering – New concepts, accomplished projects, and visions for the interaction between building structure, envelope and energy technologies.

TU München, Prof. Dipl.-Ing. Thomas Auer, **TU Darmstadt**, Prof. Dr. Ing. Jens Schneider and **TU Delft**, Prof. Dr.-Ing. Ulrich Knaack are organizing the PowerSkin Conference in collaboration with BAU 2017. It is the first event of a biennial series. On January 19th, 2017 architects, engineers and scientists present their latest developments and research projects for public discussion.

Publisher

TU Delft Open
TU Delft / Faculty of Architecture and the Built Environment
Julianalaan 134, 2628 BL Delft, The Netherlands

Editors

Thomas Auer
Ulrich Knaack
Jens Schneider

Editorial office

TU Darmstadt – Miriam Schuster (MSc)
TU München – Uta Stettner

Design & layout

Design – Sirene Ontwerpers, Rotterdam
Layout – Phoebus Panigyrakis, TU Delft

Cover image

Museum de Fundatie, Zwolle

©2017 TU Delft Open
ISBN 978-94-92516-29-9



Contents

- 007 Preface
- 011 **KEYNOTES**
- 015 **ENVIRONMENT**
- 017 **Designing façades for carbon neutral buildings**
Winfried Heusler
- 027 **Building Envelope as Heat Generator –
The impact of Water-filled ETFE Cushion on Energy saving and Comfort**
Abolfazl Ganji Kheybari, Jochen Lam
- 039 **Anaerobic domestic waste water treatment coupled to a bioreactor
façade for the production of biogas, heat and biomass***
Martin Kerner
- 049 **Free-Form 2.0 –
Building prefabricated segmented concrete free-form Shells**
Alexander Stahr, Martin Dembski, Michael Theuer, Lars Janke
- 061 **Machine code functions in BIM for cost-effective high-quality buildings**
Christoph Maurer, Wendelin Sprenger, Steffen Franz, Jan Lodewijks, Uwe Rüppel, Tilmann E. Kuhn
- 071 **Thermal and Energy Performance of Double Skin Facades
in Different Climate Types**
Ajla Aksamija
- 083 **How Material Performance of Building Façade Affect Urban Microclimate**
Ata Chokhachian, Katia Perini, Mark Sen Dong, Thomas Auer
- 097 **An investigation on the relation between outdoor comfort and
people's mobility – The Elytra Filament Pavilion survey**
Daniele Santucci, Eduard Mildemberger, Boris Plotnikov
- 109 **Updated urban facade design for quieter outdoor spaces***
Jochen Krimm, Holger Techen, Ulrich Knaack
- 111 **Optimised Parametric Model of a Modular Multifunctional Climate
Adaptive Façade for Shopping Centres Retrofitting***
Riccardo Pinotti, Stefano Avesani, Annamaria Belleri, Giuseppe De Michele, Philip Ingenhoven

- 113 **Field monitoring in Mediterranean climate to quantify thermal performances of vertical greening systems**
Katia Perini, Francesca Bazzocchi
- 123 **Benefit E2 – Building integrated solar active strategies**
Christoph Kuhn, Steffen Wurzbacher, Christoph Drebes
- 133 **FAÇADE DESIGN**
- 135 **Research and Development of Innovative Materials at the Convergence of Art, Architecture and New Technologies**
Heike Klussmann, Thorsten Klooster
- 147 **Retrofit of a “Brutalist” office building from the ‘70s in Rome**
Alberto Raimondi
- 159 **Variable Façade – Method to apply a dynamic façade solution in Santiago, Chile**
Claudio Vásquez, Renato D’Alençon
- 171 **Integration of technology components in cladding systems**
Philipp Molter, Tina Wolf, Michael Reifer, Thomas Auer
- 179 **Multi-active façade for Swedish multi-family homes renovation: Evaluating the potentials of passive design measures***
Susanne Gosztonyi, Magdalena Stefanowicz, Ricardo Bernardo, Åke Blomsterberg
- 181 **Light-transmitting energy-harvesting systems – Review of selected case-studies**
Marcin Brzezicki
- 191 **Silicones enabling crystal clear connections**
Valérie Hayez, Dominique Culot, Markus Plettau
- 201 **GFRP Reinforcement and Anchorage Concepts for filigree Energy-Efficient Façades made of UHPC**
Milan Schultz-Cornelius, Matthias Pahn
- 213 **Thermal optimization of curtain wall façade by application of aerogel technology***
David Appelfeld
- 215 **Fixed sunshade device for overhead glazing**
Daniel Kleineher
- 227 **Subdivided switchable sun protection glazing****
Marzena Husser, Walter Haase, Werner Sobek

- 229 **FAÇADE ENGINEERING**
- 231 **A zero-energy refurbishment solution for residential apartment buildings by applying an integrated, prefabricated façade module**
Thaleia Konstantinou, Olivia Guerra-Santin, Juan Azcarate-Aguerre, Tillmann Klein, Sacha Silvester
- 241 **Timber Prototype – High Performance Solid Timber Constructions**
Hans Drexler, Oliver Bucklin, Angela Rohr, Oliver David Krieg, Achim Menges
- 253 **Powerskin – Fully Fashioned***
Claudia Lüling, Iva Richter
- 255 **Solar Concentrating Façade**
Sidi Mohamed Ezzahiri, Badia S. Nasif, Jan Krieg, Anco Bakker, Carlos Infante Ferreira
- 267 **Viability study of Solar Chimneys in Germany – Analysis and Building Simulation**
Lukas Schwan, Eabi Kiluthattil, Madjid Madjidi, Thomas Auer
- 279 **Hybridization of solar thermal systems into architectural envelopes**
Beñat Arregi, Roberto Garay, Peru Elguezabal
- 289 **Solar façades – Main barriers for widespread façade integration of solar technologies***
Alejandro Prieto, Ulrich Knaack, Thomas Auer, Tillmann Klein
- 291 **Solar PV Building Skins – Structural Requirements and Environmental Benefits***
Claudia Hemmerle
- 293 **Infra-Lightweight Concrete – A monolithic building skin**
Mike Schlaich, Alex Hückler, Claudia Lösch
- 305 **Cellular Lattice-Based Envelopes with Additive Manufacturing***
Roberto Naboni, Anja Kunic, Luca Breseghello, Ingrid Paoletti
- 307 **3d-Printed Low-tech Future Façades – Development of 3d-printed Functional-Geometries for Building Envelopes**
Moritz Mungenast
- 319 **Convective Concrete – Additive Manufacturing to facilitate activation of thermal mass***
Dennis de Witte, Marie L. de Klijn-Chevalerias, Roel C.G.M. Loonen, Jan L.M. Hensen, Ulrich Knaack, Gregor Zimmermann

* Full paper published in JFDE / Journal of Façade Design and Engineering, Volume 5, Number 1, 2017.

** Full paper published in GS&E / Glass structures & Engineering, 2017.

Preface

The “third skin” of human beings – the building envelope – has a long history of development with a major impact on architecture. As an interface between inside and outside, facades not only determine aspects such as performance and energy efficiency, they also determine the aesthetics of buildings and cities; to the extent that they can create cultural identity. The invention of the curtain wall made facades independent from the building structure, but it remained an important – yet passive – element.

In the past 2 decades, the building envelope has experienced a change in its role as an adaptive climate control system that leverages the synergies between form, light, material, energy and mechanical systems in an integrated manner. Contemporary façade design aims for an optimized environmental quality while minimizing the use of resources. Indoor environmental quality and operational energy performance were a main focus in the 1990s, whereas in the next decade, design and research also put more and more consideration into outdoor environmental quality. Current research is focusing on materiality in the context of building life cycle, design integration and maintenance. Sustainable, smart materials – providing an auto-reactive, passive environmental control mechanism – as well as active systems for environmental control, along with energy generation and storage became areas for both R&D and construction practice.

Over the past decades, glass developed into the dominating cladding material due to its improved thermal performance and adaptability with regard to transparency, solar and daylight control. This allows a flexible interaction between the indoor and outdoor environment and offers the potential of a dynamic control strategy. Recent developments provide an integration of mechanical climate control systems – such as decentralized mechanical ventilation – and components for energy generation and storage.

On the one hand, this could lead to a building design that is fully independent of local climate conditions, building culture, and other contextual aspects, while still providing an optimized environmental quality. On the other hand, it also enables architects and engineers to design buildings that interact with and adapt to climate conditions and user demands as well as respect local conditions and local context. Such a design approach provides the opportunity to bring the local identity back into the architectural language.

The PowerSkin Conference and the proceedings address three main topics: Façade, Structure and Environment. The presentations and papers showcase recent scientific research and developments, along with projects related to building skin from the perspectives of material, technological and design.

We would like to express our thanks and appreciation to our peers and colleagues, willing to participate in the intensive process of reviewing abstracts and papers – supporting the experienced conference participants to further develop and improve. Special thanks to Prof. Dr. Anne Beim / KADK Copenhagen; Paul Carew / PJC Consulting Cape Town; Prof. Dr.-Ing. Tillmann Klein / TU Delft and TU München; Prof. Dr. Stephen Selkowitz, Lawrence Berkley National Lab (LBNL); Prof. Dr.-Ing. Frank Wellershoff / HafenCity University Hamburg. Also we would like to thank Thaleia Konstantinou / TU Delft; Phoebus Ilias Panigyrakis / TU Delft; Véro Crickx / Rotterdam and Frank van der Hoven / TU Delft for their support with the journal and the conference proceeding.

And finally: our biggest thank you goes to Uta Stettner / TU München and Miriam Schuster / TU Darmstadt – they were the engine pushing the development process and the conference itself. Great work!

Thomas Auer
Ulrich Knaack
Jens Schneider



Prof. Dipl.-Ing. Thomas Auer

Trained as a Process Engineer at the Technical University in Stuttgart, Thomas is a partner and managing director of Transsolar GmbH, a German engineering firm specialized in energy efficient building design and environmental quality with offices in Stuttgart, Munich, Paris and New York. In January of 2014 Thomas became Professor for building technology and climate responsive design at the TU Munich. Thomas collaborated with world known architecture firms on numerous international design projects and competitions. A specialist in the fields of integrated building systems and energy efficiency in buildings as well as sustainable urban design, Thomas has developed concepts for projects around the world noted for their innovative design and energy performance – an integral part of signature architecture. The office tower for Manitoba Hydro in downtown Winnipeg, Canada – is considered one of the most energy efficient high-rise buildings in North America. Lower Don lands, Toronto – is going to be among the first carbon neutral districts in North America. Outside of Transsolar, Thomas taught at Yale University and was a visiting professor at the ESA in Paris and other Universities. He speaks frequently at conferences and symposia. In 2010 Thomas received the Treehugger "best of green" award as "best engineer".



Prof. Dr.-Ing. Ulrich Knaack

Prof. Dr.-Ing. Ulrich Knaack (1964) was trained as an architect at the RWTH Aachen / Germany. After earning his degree he worked at the university as researcher in the field of structural use of glass and completed his studies with a PhD. In his professional career Knaack worked as architect and general planner in Düsseldorf / Germany, succeeding in national and international competitions. His projects include high-rise and office buildings, commercial buildings and stadiums. In his academic career Knaack was professor for Design and Construction at the Hochschule OWL / Germany. He also was and still is appointed professor for Design of Construction at the Delft University of Technology / Faculty of Architecture, Netherlands where he developed the Façade Research Group. In parallel he is professor for Façade Technology at the TU Darmstadt / Faculty of Civil engineering / Germany where he participates in the Institute of Structural Mechanics and Design. He organizes interdisciplinary design workshops and symposiums in the field of façades and is author of several well-known reference books, articles and lectures.



Prof. Dr.-Ing. Jens Schneider

Prof. Dr.-Ing. Jens Schneider (1969) is a full professor for structural engineering at the Institute of Structural Mechanics and Design, TU Darmstadt (Germany). After his studies in civil engineering in Darmstadt and Coimbra (Portugal), he received his PhD from TU Darmstadt in 2001 in a topic about structural glass design. From 2001-2005 he worked at the engineering office Schlaich, Bergermann and Partner, where he was involved in the structural design of complex steel, glass and concrete structures. In 2006 he was appointed as an authorized sworn expert on glass structures, in 2007 to the position of a professor for structural engineering in Frankfurt and in 2009 to his current position at TU Darmstadt. Since 2011, he is also partner in his engineering office SGS GmbH in Heusenstamm / Frankfurt. Since 2015, he leads the European project group for the preparation of the new Eurocode 11 „Structural Glass“. He is specialized in structural mechanics of glass & polymers, façade structures, structural design and synergetic, energy-efficient design of façades and buildings.

SCIENTIFIC COMMITTEE



Prof. Dipl.-Ing. Thomas Auer



Prof. Dr.-Ing. Ulrich Knaack



Prof. Dr. Anne Beim



Prof. Dr.-Ing. Jens Schneider



Paul Carew, B.Eng.



Prof. Dr. Stephen Selkowitz



Prof. Dr.-Ing. Tillmann Klein



Prof. Dr.-Ing. Frank Wellershoff

KEYNOTES

Achim Menges

INSTITUTE PROFILE

The Institute for Computational Design (ICD) at the University of Stuttgart was founded in 2008. It is dedicated to the teaching and research of computational design and computer-aided manufacturing processes in architecture. The ICD has received international recognition as particularly innovative research setting and has garnered considerable research funds.

The ICD's goal is to prepare students for the continuing advancement of computational processes in architecture, as they merge the fields of design, engineering, planning and construction. The interrelation of such topics is exposed as both a technical and intellectual venture of formal, spatial, constructional and ecological potentials.

There are two primary research fields at the ICD: the theoretical and practical development of generative computational design processes, and the integral use of computer-controlled manufacturing processes with a particular focus on robotic fabrication. These topics are examined through the development, specifically, of computational methods which balance the reciprocities of form, material, structure, and environment, and integrate technological advancements in manufacturing for the production of performative material and building systems. The LBNL Windows/Daylighting/Façade team has been exploring these challenges for 40 years, collaborating with researchers, manufacturers, design teams, and building owners globally to move viable solutions into practice. Much of this body of work can be reviewed at <http://facades.lbl.gov> and over 300 publications can be downloaded from <http://eta.lbl.gov/publications>



Achim Menges is a registered architect and professor at the University of Stuttgart, where he is the founding director of the Institute for Computational Design at the University of Stuttgart. In addition, he currently also is Visiting Professor in Architecture at Harvard University's Graduate School of Design. He graduated with honours from the AA School of Architecture in London, where he subsequently taught as Unit and Studio Master in the AA Diploma School and AA Graduate School.

Achim Menges practice and research focuses on the development of integrative design processes at the intersection of design computation, biomimetic engineering and robotic manufacturing that enables a performative and sustainable built environment. His institute is an integral part of the DFG Collaborative Research Centre SFB-TRR 141 "Biological Design and Integrative Structures" and the DFG Collaborative Research Centre SFB 1244 "Adaptive Skins and Structures". He has published several books on this work and related fields of design research, and he is the author/coauthor of more than 125 scientific papers and numerous articles. His projects and design research has received many international awards, has been published and exhibited worldwide, and form parts of several renowned museum collections.

Stephen Selkowitz

FUTURE BUILDING SKINS – SMART, ACTIVE AND ADAPTIVE FAÇADE SOLUTIONS

The building skin alternately connects occupants to the pleasures of the external environment and shelters them from its harshest impacts, using materials, systems and energy to actively manage that relationship. Given the dynamics and extremes of the outdoor environment and the changing personal and functional needs of occupants, successful management requires an active and adaptive building skin that senses and responds to changing needs and requirements. This concept is not new, but it is rarely executed effectively since elegant conceptual designs often run afoul of the realities of the physics of heat and light, the frailties of technology, the challenge of budgets and the behaviour of people, typically defaulting to a static compromise solution that rarely satisfies divergent performance needs. In this presentation we look ahead over a 5 to 15 year time horizon to first define a series of idealized, yet achievable trends and solutions, then identify the technologies, systems, tools and processes we would need to realize them and finally explore how to accelerate some promising high performance glazing, shading and daylighting systems options that will deliver these solutions to a range of building applications and markets.

The LBNL Windows/Daylighting/Façade team has been exploring these challenges for 40 years, collaborating with researchers, manufacturers, design teams, and building owners globally to move viable solutions into practice. Much of this body of work can be reviewed at <http://facades.lbl.gov> and over 300 publications can be downloaded from <http://eta.lbl.gov/publications>



Stephen Selkowitz is Senior Advisor for Building Science, Lawrence Berkeley National Laboratory, now in a part-time research and strategic planning role after leading LBNL's building performance teams in research, development, and deployment of energy efficient technologies and sustainable design practices for 40 years. An internationally recognized expert on window technologies, window software tools, façade systems, shading solutions, daylighting, and integrated building systems solutions he created and then led the LBNL Windows and Daylighting Group until 2015. The LBNL team has been instrumental in partnering with industry to introduce new technologies to building markets, e.g. low-e, spectrally selective and electrochromic coatings, and in creating a suite of tools used by researchers, manufacturers and designers globally, e.g. WINDOW, THERM, Optics, Radiance, Energy Plus. He served as Department Head for the LBNL Building Technologies Department for 25 years, partnering with industry to develop and demonstrate new building technologies, systems, processes and tools. He serves as Scientific Advisor to four building science programs globally that address zero net energy building solutions, is employed as a consultant to industry, has spoken at over 400 scientific, business and industry venues and authored over 170 publications, 4 books and holds 2 patents. He holds an AB in Physics from Harvard College and an MFA in Environmental Design from California Institute of the Arts. In 2012 he was the recipient of the first LBNL Lifetime Achievement Award for Societal Impact and in 2014 won McGraw Hill/ENR's prestigious Award of Excellence for "relentlessly working to reduce the carbon footprint of buildings and for moving the nation towards better building performance."

ENVIRONMENT

Designing façades for carbon neutral buildings

Winfried Heusler¹

¹ Schüco International KG, Germany, www.schueco.com; Detmold School of Architecture and Interior Architecture, www.hs-owl.de/fb1

Abstract

Façades are vital not only for the external appearance, but also for the usability and durability of buildings, for the protection of people and property, and for creating a comfortable indoor climate. More than that they have a huge impact on operating and embodied energy of buildings. To end up in a carbon neutral building we first of all have to extend the period in which the interior conditions can be kept comfortable without the need for mechanical systems. The solution is a holistic design approach with the goal to optimize the façade appearance and performance from operating and embodied energy. The most promising approach for that challenging task is based on five principles:

- Designing facades modularly with integrated and scalable functional groups.*
- Integrating HVAC- and solar-system-components into the façade.*
- Consequent application of system technology for each of the different trades.*
- Proper use of cyber-physical systems within the entire lifecycle.*
- Using the principles of a holistic parametric design process.*

The objective of this paper is to give an overview of challenges and trends in advanced façade technology.

Keywords

operating energy, embodied energy, passive, active, cognitive, modular, system technology, smart tech

1 INTRODUCTION

Across centuries, building forms and types have been adapted to local climatic conditions, based on the use of natural resources. Only in the 20th century did the advent of heating and air conditioning systems allow the design of building envelopes independently of the conditions and parameters of the local setting. However, this development came at a price. Not only are the initial and operating costs on the rise but the dependency on complex technology. The increasing need for energy and raw materials as well as the resulting CO₂-emissions are alarming consequences.

In December 2015 a global climate change agreement that laid the groundwork for a low-carbon future was signed in Paris. In order to make that idea a reality, governments, companies and individuals have to work together. Buildings are directly responsible for approximately 40 % of the worldwide energy consumption. Because of their life expectancy mistakes we make today will lead in the long term to an economic, ecological and sociocultural burden. This is the main reason why almost worldwide there is a rising awareness of sustainability and why advanced concepts for “green” buildings are in fashion within the architectural society. Having said this we have to keep in mind that besides practical aspects we have to consider the regional culture of building (“Baukultur”) with its specific formal and symbolic aspects.

According to the target set by the Federal Government for the energy transformation (Energiewende) Germany’s building stock is to become “nearly climate-neutral” by 2050. A carbon neutral building is defined as one with significantly reduced energy consumption combined with the increased use of low carbon energy sources to meet the remaining demand (Carruthers & Casavant, 2013). Within this paper the definition of carbon neutral buildings includes the components operating and embodied energy as well as the resulting CO₂-emissions. Façades are vital not only for the external appearance, but also for the usability and durability of buildings, for the protection of people and property, and for creating a comfortable indoor climate. Nevertheless we will have a focus on the role of façades to achieve a carbon neutral building stock.

2 INFLUENCE OF FACADES ON OPERATING ENERGY

Operating energy and CO₂-emissions refer to the equipment for running the façade (e.g. electric drives) as well as for heating, ventilating, cooling and lighting of the building. An energy efficient façade - on the one hand - minimizes the operating energy - on the other hand - the size or even the necessity of HVAC-equipment. To end up in a carbon neutral building we first of all have to extend the period in which the interior conditions can be kept comfortable without the need for mechanical systems. It is important to point out, however, that this must not be at the expense of room comfort, which has an impact on well-being and productivity of people. Thus the importance of a comfortable temperature, fresh air and the use of daylight cannot be overestimated. Poor designs create unacceptable comfort levels despite needing enormous amounts of energy. The starting point of a holistic optimization process is thoroughly analyzing the site. It has to include both environmental and climate factors in order to check the critical issues (negative forces) and potentials (positive forces) offered by the site that could be useful to control the indoor environmental conditions (Ausiello & Raimondo, 2014). A key factor is having a building structure that is suitable for its location and its use, in conjunction with an appropriate façade (Daniels, 1995).

The energy efficiency can be increased considerably if project-specific requirements are placed on room comfort, rather than just general measures, which may be over-stringent. Ideally, relevant comfort limits are defined separately for each building zone. It can be further optimized if the designer widens the “systemic boundaries”. For example, a weather-protecting enclosure between neighboring building parts may be designed as a large buffer zone, resulting in an atrium or mall-type space. Within tolerable limits their internal conditions are free floating, defined by the thermal behavior of the building. The internal surfaces of such spaces are relatively simple and do not require any particular attention in regards to wind loads or driving rain. Important nevertheless are the effects with regard to internal noise (“sound attenuation”) and thermal storage behavior (“thermal buffering”). Energy efficient buildings can be designed on basis of passive, active or cognitive concepts (Heusler, 2013).

2.1 PASSIVE CONCEPTS

Depending on where the building is located, it is affected by various environmental factors, namely noise, wind, precipitation, cold, heat and radiation from the sun. A passive façade seals off the interior from those external factors as far as possible. Contemporary mechanical systems ensure a comfortable interior environment. With advanced passive facades it is possible to even out long term differences between outside climatic influences and interior comfort conditions independent of the season. Short term variations for instance between day- and nighttime can be dampened and smoothed out as well. In regions with temperate climates, the most important functions of the building envelope consists, above all, of ensuring thermal insulation. This requires an overall optimization of frame, glazing and non-transparent areas of the facade. Thermal bridging within the component and where individual components are joined is also of significance. The better the quality of thermal insulation of a facade, the more important is a focus on thermal loss due to ventilation or infiltration. The overarching goal must be that uncontrolled ventilation due to gaps in the construction needs to be avoided. However, optimizing energy consumption must not end with heat loss. By using passive solar energy, the building itself acts as a solar collector. Transparent and translucent areas of the facade capture solar energy for space heating. In the case of buildings with high internal loads and large glass surfaces, solar radiation can occasionally cause overheating if no additional measures are considered. External shading systems reduce the solar radiation and the resulting thermal gains noticeable (Heusler, 2004). Daylighting systems can optimize interior lighting by evenly distributing the daylight entering the room (Heusler & Scholz, 1992).

2.2 ACTIVE CONCEPTS

In active building concepts dynamic façade components respond specifically to changing internal and external conditions (Heusler, 2013). The aim here is to minimize the use of mechanical systems, especially by means of natural ventilation, improved passive use of solar energy and daylight through operable windows, active sun-shading (Heusler, 2004) and movable daylighting systems (Heusler & Scholz, 1992). In comparison with twin-wall façades, considerably better thermal insulation results can be achieved by means of movable, temporary thermal insulation, especially if vacuum-technology is used as within the Schüco-2-Degree-Concept at BAU 2011 in Munich (see fig. 1). It is important to point out that the knowledge and behavior of users and/or operators of buildings, an aspect we may call “Operational Competence” becomes of increasing significance in active concepts. The most innovative building concept will inadvertently fail if it only performs in theory.



FIG. 1 Active façade with temporary thermal insulation using sliding vacuum panels (white surface finish) as part of the Schüco-2-Degrees-Concept (Source: Schüco International KG)

According to my personal experience purely passive building concepts are only advantageous if the location, the height or the use of the building excludes natural ventilation, as well as solar energy and use of daylight for at least two-thirds of the year. In tall buildings natural ventilation through conventional windows and external solar shading installations is pushed to its limit by high wind loads.

2.3 COGNITIVE CONCEPTS

Adaptive building envelopes are able to interact with the environment and the user by reacting to external influences and adapting their behaviour and functionality accordingly. The idea for this principle first came up as Le Corbusiers "Mur Neutralisant and Respiration Exacte" within a proposal for „City of Refuge“ / Paris in 1929 (Diaz & Southall, 2015). In 1981 Mike Davies (Davies, 1998) picked up Le Corbusier`s idea and optimized it as his theoretical "polyvalent wall". It would control the flow of energy from the exterior to the interior using extremely thin layers. The membrane would have the ability to absorb, reflect, filter, and transfer energies from the environment. According to Davis (Davies, 1998), it would continuously adapt and change to the surrounding conditions and act as a filter in both directions, interior and exterior. The "polyvalent wall" acts as a driving force for new façade technologies since that time (Ataman & Rogers, 2006) (Loonen, 2010). Together with Richard Rogers Mike Davis put parts of his concept into practice for the first time in the "Lloyds of London Redevelopment" Project / London finished in 1986.

In many moderate climatic zones, optimum energy efficiency is provided by cognitive building concepts (Dascal & Dror, 2005). In relation to specific microclimatic conditions, their adaptive façades can modulate external signals. They are connected to mechanical-system components with dynamically adjustable functions through an intelligent building automation system. Adaptive components of the facade are capable of reacting to non-continuous, changing external and internal conditions that are in many instances predictable and can be calculated, such as the case with annual or diurnal swings in meteorological conditions (i.e., solar altitude angle) or the times of a building's operation. However, non-predictable weather and operational aspects - such as variations in cloudiness and spontaneous presence of users - should be included by means of appropriate sensors or via the Internet through the weather forecast. Within the European research project COST TU 1403 "Adaptive Facades Network" scientists, engineers, architects and industry partners from 26 countries are sharing their knowledge, expertise, resources, and skills in the fields relevant to adaptive facades (Luible, et al., 2015).

Nowadays simulation tools allow for predicting the buildings free floating behavior in relation to varying external and internal conditions. They are the starting point of an anticipatory controlled, prioritized and coordinated operation of the façade's individual components. It will purposively balance parameters such as its total energy transmittance and heat transmission and by this maximize "zero-energy-states". The efficiency of passive nighttime cooling can be enhanced if lower temperatures are acceptable in the morning in not permanently used zones of the building. The upper mentioned buffer zones may be equipped with cognitive envelopes to provide a general thermal environment ranging in air temperatures between 15 and 30°C annually, largely independent of external weather conditions.

In the past there has been a gap between new technologies and their application into architecture. Recent developments in digital technologies and smart materials have created new opportunities and are suggesting significant changes in the way we design and build buildings (Attmann, 2012). A new architectural material class will merge digital and material technologies. Sensors and electronics will be embedded in architectural components such as glass. Cyber-physical systems (CPS) represent the next evolutionary step from existing embedded systems (acatech, 2011). The computational and physical processes are tightly interconnected and coordinated to work together effectively, often with humans in the loop. The potential of CPS to change every aspect of life is enormous. They will shift the reliance on human decision making into new, more strategic aspects and will increasingly rely on operationalizing human knowledge through computational intelligence (N.N., 2013). The basis is a system that can interact appropriately with humans and the physical world in dynamic environments and under unforeseen conditions. In combination with cognitive technologies CPS will have an enormous influence on architecture and the building industry.

3 INFLUENCE OF FACADES ON EMBODIED ENERGY

If buildings use nearly zero energy for operation, the ecological quality of a building is defined by its materials (Hildebrand, 2014). Therefore the second step to a carbon neutral building is taking into consideration the CO₂-emissions associated with energy embodied in the building materials. There is carbon involved in the extraction of the resources that are used to create materials for facades as well as in the production and installation of facades. The optimization process has to consider the entire lifecycle, from design and construction, through operation, service and maintenance, updating and upgrading as well as demolition and recycling. Resource efficiency stimulates the minimization, material effectiveness the optimization of embodied energy over the life cycle phases of a building and its components. Truly material-effective facades incorporate the following factors:

- optimizing the materials used in their construction
- minimizing the wastage of materials along the whole lifecycle
- optimizing maintenance, servicing and modernization
- increasing the recycling properties of components.

To achieve the lowest possible ecological impact, the architect first of all has to create a compact building with an efficient layout and optimized A/V ratio. The second step is integrating the end of life into the planning process (Hildebrand, 2014). The goal is minimizing the consumption of primary resources by means of a closed loop construction. There is a preference of re-using building components over recycling materials. In the end the challenge is that the old components do not fulfil contemporary functional requirements. Urban mining has to be taken into consideration. Reducing scrap and recycling production waste are representing the next steps. Other potential areas include minimizing wastage in the storage, packaging and transportation process.

Another topic is the intended life span. Every building and its components are subject to ageing. Careful and proper usage, regular cleaning, servicing and maintenance work can only slow the process of the materials ageing. Irrespective of this, however, a building and its fixtures and fittings may become obsolete if these no longer meet today’s comfort and quality requirements (“immaterial ageing”). The building structure is subject to less exchange cycles compared to the facade or even the building interior. Therefore disassembly and reassembly of building components need to be taken into consideration. In this context the importance of modular principles and system technology cannot be overestimated.

3.1 MODULAR PRINCIPLES

The modular principle is a design approach that subdivides a system (in our case a building) into smaller parts called modules. Nowadays the separation of a load bearing skeleton-construction and a non-loadbearing curtain wall is common in high-rise buildings. In many cases the principle goes one step further: The curtain wall is subdivided into unitized scalable modules. They can be developed and produced independently (most favorably in specialized factories) and used in different configurations (usually installed on site). Such modules comprise enclosed frames of façades including glass, panel, metal sheet and insulation, in extreme cases with natural stone and solar shading, sensors and motors. In the development of modules and sub-assemblies, the differences in ageing as well as the maintenance, servicing and modernization cycles of the individual components have to be taken into account.

The major advantage of unitized façades in contrast to stick-systems, is the high degree of automation and accuracy possible under controlled factory conditions. The result is reliable quality. The modules are transported in their entirety to site and fitted to consoles which were previously attached to and adjusted on the building’s structure. By this unplanned improvisation and wastage will be minimized. Reduced dependency on the weather provides a substantial basis for consistency of quality.

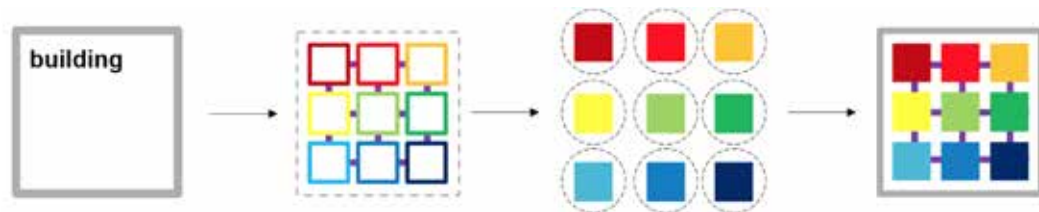

FIG. 2 The modular principle (Source: Schüco International KG)

3.2 SYSTEM TECHNOLOGY

A good modular system is characterized by thoroughly optimized interfaces between adjacent modules. They are extremely important in the maintenance and demolition-process of building materials. It is possible to reduce the embodied energy of facades if their internal and external interfaces are based as far as possible on task-specific standards. System technology standardizes building components with identical or similar parts, and harmonizes the link between the components (in terms of their dimensions and geometric interfaces). The application of this principle to the facade entails optimizing as many components as possible from an economic and ecological, as well as from an embedded energy point of view.

As there are fewer different construction types and parts, the design is less complex. In addition, components that are commercially and industrially (pre)fabricated as standard products are less complex than custom designed products. The more extensive and well thought-out the system and the more intelligently the planners and designers use it in adapting the design to fit the project specific requirements, the greater the chance of combining the system components to meet technical and design requirements in an efficient and individual way.

The wastage of materials can be considerably reduced if materials are re-used. If this is not possible, materials can be recycled preferentially. The choice of bonding technology and the connecting of materials will determine whether demolition results only in special waste that is uneconomical to recycle or in building materials that can be separated easily and cleanly.

4 INTEGRATION OF HVAC AND SOLAR COMPONENTS INTO THE FAÇADE

As early as in 1999 SCHÜCO presented its CONCEPT façade at the BAU fair in Munich as a study based on the principles of integrated design and decentralized building plant components. Besides the automation and control of windows for natural ventilation, the integration of movable solar shading (with pivotable glass louvres), decentralized mechanical ventilation (with heat recovery and heat storage) and photovoltaic or solar thermal systems (including small decentralized adsorption chillers), has been realized using the principle of modularization. The CONCEPT facade harmonized all of the curtain wall's components, including the HVAC and solar components as well as the control system, that offers the possibility of connecting facade components and the building plants components so that they can intercommunicate.

Since that time step by step ideas of the CONCEPT façade have been transferred into real products, not only at SCHÜCO. We are nowadays facing a large variety of mechanical, electric and electronic components as well as new materials within advanced facades. Different trades' competences are necessary for the successful solution of this cross-disciplinary challenge. In the current façade industry the principle of convergence represents the next evolutionary step towards value-added solutions for the building's life cycle. Convergence is the merging of industries and the blurring of existing lines, within which single enterprises used to position themselves in the past.

4.1 INFLUENCE ON OPERATING ENERGY

In several projects de-centralized mechanical ventilation components have been integrated into the façade (Hartwig, Hellwig, Giertlová, Marghescu, & Ehlers, 2003). As they are equipped with regenerative heat exchangers the ventilation heat loss can be reduced. If they incorporate phase-change-materials (PCM), they are capable of balancing diurnal temperature fluctuations. If the capability to store thermal energy is great and, additionally, the local climate possesses the advantage of diurnal temperature swings, mechanical cooling systems may even become obsolete.

If a building is optimized with regard to its energy efficiency, it is recommended – as the final step to achieve a carbon neutral building – that renewable energy sources be considered to compensate for the remaining energy consumption. In the case of facades, mainly two available active-solar energy sources are to be considered: electric and thermal.

The direct use of solar radiation for space heating and hot water consumption can be achieved with various available systems, which work according to various principles, such as air or water collectors or heat absorbers with heat pumps. Their performance can be increased with the addition of (probably decentralized) thermal storage systems. Especially for the building type of an office building, the generation of cooling energy with the help of thermal collectors and absorption chillers is of great interest (Khelifa, 1985) (Safarik, 2003). The principle is simple: in case of the highest cooling demand, the sun will provide the maximum intensity and potential for the cooling-process. This, of course, is an elegant balance between „supply and demand“.

Building-integrated photovoltaic systems (BIPVs) today have long passed the experimental phase. Thanks to system technology the problems of proper cable routing and electric connectors are solved in detail, and excellent systems are available.



FIG. 3 Photovoltaics and thermal collectors integrated into the building envelope; the Schüco-E²-Façade (Source: Schüco International KG)

4.2 INFLUENCE ON EMBODIED ENERGY

The CO₂-emissions associated with energy embodied in the above mentioned components can be reduced by using modular principles and system technology. By designing facades with integrated and scalable functional groups for each of the different trades, even complex project specific solutions can be planned and executed more efficiently, flexible and with a higher quality. The basis for this advanced concept is the cooperation between the functional groups through optimized interfaces. Modular systems - with standardized functional principles - are favorable for that purpose. The modules can be developed and produced independently in specialized factories and installed on site by specialized installers. Within the modular concept the differences in ageing as well as the maintenance, servicing and innovation cycles of the individual components from the different trades have to be taken into account.

In the end the application of the modular principle and system technology to the HVAC- and solar-system-components leads to an optimization regarding economic and ecological aspects as well as with regard to embedded energy. Extremely important (especially in terms of warranty) are the interfaces between the different trades modules. Standardized and optimized adapters or docking-stations seem to be a good solution for this complex task.

5 SMART TECH CONCEPTS

The basic question is whether a low tech or a high tech solution is the better one in terms of operating and embodied energy as well as CO₂-emissions. From my personal point of view neither the low tech nor the high tech but the smart tech concept is the best one. It uses only as much technology as ultimately necessary. It follows the "lean-approach" to diminish or even eliminate the unnecessary and useless consumption of energy, materials, time and money (Daniels, 1998). Following the bioclimatic design strategy (Yeang, 1995) (Yeang, 1996), the aim is to minimize the use of mechanical systems by means of natural ventilation as well as the passive use of solar energy and daylight.

The building and its facade have to be developed according to the project specific boundary conditions. Many mega cities (with high growth rates) are in regions with tropical climates. One solution for that specific climatic zone can be the passive building concept. The alternative is to return to the traditional cooling method of natural ventilation and to create building zones with different levels of comfort in accordance with the onion peeling principle. The core zone has to be sealed off from the surrounding buffer zones (airtight and well insulated). Court yards, atria, loggias and sky gardens can be part of those concepts. The outer layer should not be glass but a rigid, partially transparent solar shading installation that allows the permeation of air. Movable and in particular motor-driven components in such regions are only suited to buildings whose owners have a positive attitude to maintenance.

Independently of the location an important point is not to focus on improving individual components, but to optimize the overall performance of the building structure, building envelope, interior walls, floors, ceilings, storage mass, technical fixtures and fittings, and building management technology. The optimum method for that highly complex task is using the principle of parametric design. It uses variables and algorithms to generate a hierarchy of mathematical and geometric relations. It serves the automated generation of geometries of architectural elements and physical characteristics of the components that change their properties based on formal relations. It is the shift from using CAD software as a drafting tool, to an efficient design tool - for the development of smart tech concepts.

The actual challenge in the holistic design approach is to decouple the façade appearance and performance from operating and embodied energy and their CO₂-emissions. By designing facades modularly with integrated and scalable functional groups (including minimized HVAC- and solar-system-components) and using system technology for each of the different trades seems to be a promising way. In combination with the proper use of cyber-physical systems it will have an enormous influence on architecture and the building industry.

References

- acatech. (2011). Cyber-Physical Systems: Driving force for innovation in mobility, health, energy and production.
- Ataman, O., & Rogers, J. (2006). Toward New Wall Systems: Lighter, Stronger, Versatile. Proceedings of the 10th Iberoamerican Congress of Digital Graphics (pp. 248-253). Santiago de Chile, Chile: SIGraDi.
- Attmann, O. (2012). Architecture as a Science - Integrating Macroelectronics Technology into Buildings. International Journal of Architecture, Engineering and Construction .
- Ausiello, G., & Raimondo, M. (2014). Modulation performances in the building envelope: strategy and project. GBC Sustainable Building 14.
- Carruthers, H., & Casavant, T. (2013). What is a Carbon Neutral Building? Vancouver, BC: Light House Sustainable Building Centre Society.
- Daniels, K. (1995). The Technology of Ecological Building – Basic Principles and Measures, Examples and Ideas. Birkhäuser Verlag.
- Daniels, K. (1998). Low-Tech, Light Tech, High Tech: Bauen in der Informationsgesellschaft. Birkhäuser Verlag.
- Dascal, M., & Dror, I. E. (2005). The impact of cognitive technologies: Towards a pragmatic approach. Retrieved from http://cognitiveconsultantsinternational.com/Dror_CT_pragmatics_cognitive_technologies.pdf
- Davies, M. (1998, February). A wall for all seasons. RIBA Journal.
- Diaz, L., & Southall, R. (2015). Le Corbusier's Cité de Refuge: historical & technological performance of the air exacte. Le Corbusier 50 years later, conference Valencia. Retrieved from <http://dx.doi.org/10.4995/LC2015.2015.796>.
- Hartwig, H., Hellwig, R., Giertlová, Z., Marghescu, A., & Ehlers, M. (2003). Dezentrale Fassadenlüftungstechnik. Frankfurt am Main: Forschungsvereinigung für Luft- und Trocknungstechnik e.V. (FLT).
- Heusler, W. (2004). Sommerlicher Wärmeschutz – Glasmodifikationen und Additivsysteme. Innovative Fassaden II, VDI Berichte Nr. 1811. Düsseldorf: VDI Verlag GmbH.
- Heusler, W. (2013). Bewegung in der Gebäudehülle? Gegenüberstellung passiver und aktiver Konzepte. In B. T. Weller, Glasbau 2013. Berlin: Ernst & Sohn Verlag .
- Heusler, W., & Scholz, C. (1992). Neue Tageslichtsysteme – Ergebnisse einer experimentellen Untersuchung. HLH 43 Nr. 8.
- Hildebrand, L. (2014). Strategic investment of embodied energy during the architectural planning process. Dissertation TU Delft. Delft.
- Khelifa, N. (1985). Das Adsorptionspaar Silicagel-Wasserdampf, Anwendung als solares Klimatisierungssystem. Dissertation TU München.
- Loonen, R. (2010). Overview of 100 climate adaptive building shells. Eindhoven: University of Technology. Retrieved from https://pure.tue.nl/ws/files/15945980/Loonen2010_OverviewOf100ClimateAdaptiveBuildingShells.pdf
- Luiblé, A., Overend, M., Aelenei, L., Knaack, U., Perino, M., & Wellershoff, F. (2015). Adaptive facade network - Europe. TU Delft Open for the COST Action 1403 adaptive facade network.
- N.N. (2013, January). Strategic R&D Opportunities for 21st Century Cyber-Physical Systems – Connecting computer and information systems with the physical world. Retrieved from Report of the Steering Committee for foundation in Innovation for Cyber Physical Systems: http://www.nist.gov/el/upload/12-Cyber-Physical-Systems020113_final.pdf
- Safarik, M. (2003). Solare Klimakälteerzeugung – Technologie, Erprobung und Simulation. Dissertation Universität Magdeburg.
- Yeang, K. (1995). Designing with Nature: The Ecological Basis for Architectural Design . New York: McGraw Hill, Inc.
- Yeang, K. (1996). The Skyscraper: Bioclimatically considered. London: Academy Editions.

Building Envelope as Heat Generator – The impact of Water-filled ETFE Cushion on Energy saving and Comfort

Abolfazl Ganji Kheybari¹, Jochen Lam²

1 Transsolar Academy, Curiestraße 2, 70563 Stuttgart, +49 162 876 3731, fazel.ganji@gmail.com

2 Transsolar Climate Energietechnik GmbH, Curiestraße 2, 70563 Stuttgart, +49 711 67976-195, jlam@transsolar.com

Abstract

Inspired by the human skin and the blood circulation responding to heat and cold stress, Water-filled ETFE Cushion as a dynamic multi-functional building envelope is able to interact with different weather conditions by adjusting thermal and optical properties and improve the thermal and visual comfort and reduce energy demand consequently. At the same time this façade system as a semitransparent collector can gain solar energy.

This research evaluates the impact of using different configurations of Water-filled ETFE Cushion on Energy saving and Comfort by comparing the computational thermal and daylight simulation results with a typical office building in Dubai, Tehran and Stuttgart as base cases.

The results demonstrate the efficiency of water-filled ETFE cushion as dynamic system to provide thermal and visual comfort as well as reduce the energy demand and harvest solar radiation.

Keywords

Dynamic Envelope, Façade collector, Energy saving and Comfort, ETFE cushion, Radiance, TRNSYS

1 INTRODUCTION

1.1 MULTI-FUNCTIONALITY OF FAÇADE AND SUSTAINABILITY

Increasing the transparency of architectural envelopes raises the energy demand of a building significantly in terms of heat gain and heat loss through large windows. Windows account for about 40% of total energy costs (U.S. Department of Energy, 2016) and are the major source of energy inefficiency in buildings.

Effective daylight utilization and smart use of passive solar gain are essential for achieving low-energy buildings with comfortable indoor conditions. Innovative multi-functional facade systems are able to provide responsively optimal conditions due to changing outdoor and indoor conditions and improve both the energy performance and comfort in a building by integrating solar collectors with the building's form and its behavior concept. The building envelopes have been forced to become real "active skins" with a very important energetic potential (Krippner, 2016) due to this urgent demand.

1.2 WATER FLOW GLAZING

The idea of using water as one of the best absorbers of solar energy (Otanicar, T.P., 2009) in glazing systems, has been evaluated in some projects under different names. The pioneer research is encapsulating water flow in a double glazed window to absorb the heat gain and reduce the electricity use for air conditioning system. This system as a transparent solar collector, can utilize absorbed heat for heating demands and domestic hot water (Chow Tin-tai et. al., 2011). The authors claimed two significant advantages of the system in comparison with air sealed double-glazing:

- Higher heat capacity of water, thus more heat can be absorbed and consequently removed from the cavity. to avoid overheating of the cavity in multi-layer windows.
- The removed heat which is absorbed in water can be utilized as a source of pre-heating in connection with active systems in building.

The other research project named "Fluid Glass" also developed the water filled glazing in which the solar transmittance of the glazing can be adjusted by dyeing the fluid which is circulated in chambers of the glazing (Stopper, 2013). The usage of the inner surface of the glazing as an active layer integrated into the HVAC system, increased the energy saving potential of the idea. The authors mentioned 20-30% of heating and cooling demand reduction for Munich, 50-70% for Madrid and 50-60% for Dubai (Ritter et. al., 2015).

1.3 MULTI-LAYER ETFE CUSHIONS

ETFE cushions have been largely used by architects since the 1980s as an alternative to glass because of their transparency, high thermal insulation properties, and energy and cost-efficient assembly and production processes (LeCuyer, 2008). Recent examples, such as the 2013 Enric Ruiz Geli's Media-TIC building in Barcelona and Dolce Vita Tejo shopping-complex in Lisbon, showed the concerns about overheating and glare occurrence as a big issue for using ETFE cushions in sunny and hot climates.

1.4 WATER-FILLED MULTI-LAYER ETFE CUSHIONS

The driving idea of using water bladder in a multilayer ETFE cushion is developing a dynamic shading and thermal component to interact with the variant environmental conditions. This interaction allows controlling the solar transmittance to get efficient solar heat gain during the winter and block solar heat gain during the summer while the sufficient daylight is providing. In addition, same as the Fluid glass, the large glazing area as an active heating and cooling surface can potentially improve the perception of comfort condition. The surface temperature of glazing closer to the temperature of other components of the building can also reduce the imbalance of long wave radiation in the space and raise the thermal comfort of the user (Ritter et. al., 2015).

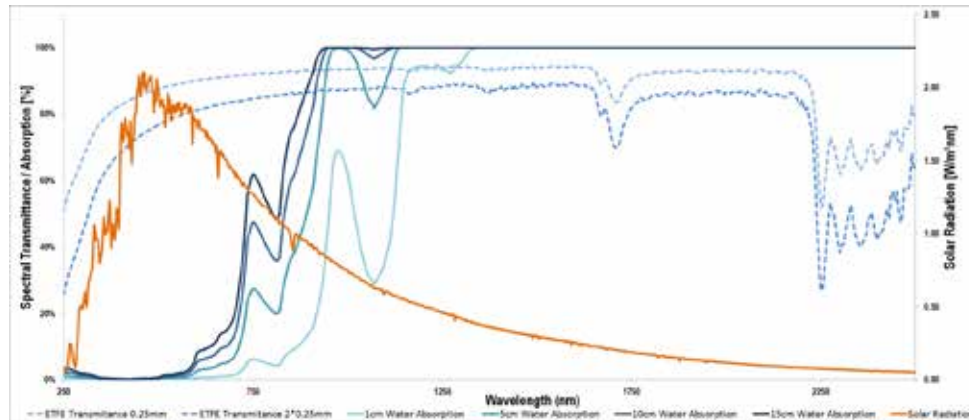

FIG. 1 Total solar Irradiation and the potential of solar envelope to gain heat. Based on the absorption coefficient of water with different thickness and ETFE foil transmission (Ganji & Lam, 2016).

Referring to Figure 1, it is noticeable that depending to the thickness of water, the light absorption in visible part of spectrum (380–700nm) in water layer is negligible (0.07% to 11.41%) but the solar absorption (250–2500nm) is significant (30.33% to 48.18%) in infrared range (Ganji & Lam, 2016). Therefore, regarding the different specular solar heat absorption and visible light transmission (T_{vis}) values corresponding to the thickness of water in this system, Water-filled ETFE cushion as a solution for semi-transparent façade element, can improve the heat gain potential of the glazing collector and reduce the energy demand by avoiding the overheating.

2 METHODOLOGY

2.1 CONCEPTUAL CONTROL SYSTEM: WATER AS BLOOD

Blood circulation and its variant velocity during cold and hot stresses are controlled by a feedback system in the hypothalamus; the temperature-regulating center of the brain (Lauster, 2009). When cold, in addition to keep the blood in internal organs of the body, by goose bump mechanism (or fluffing in birds) hairs are raised by small muscles to trap an air layer near the skin to reduce the convective heat loss. Inspired by the mammal's body interaction to variant conditions, the dynamic solar envelope made of water-filled cushions in synergy with building active systems is capable of controlling the heat flux direction for saving or rejecting the heat (Figure 2).

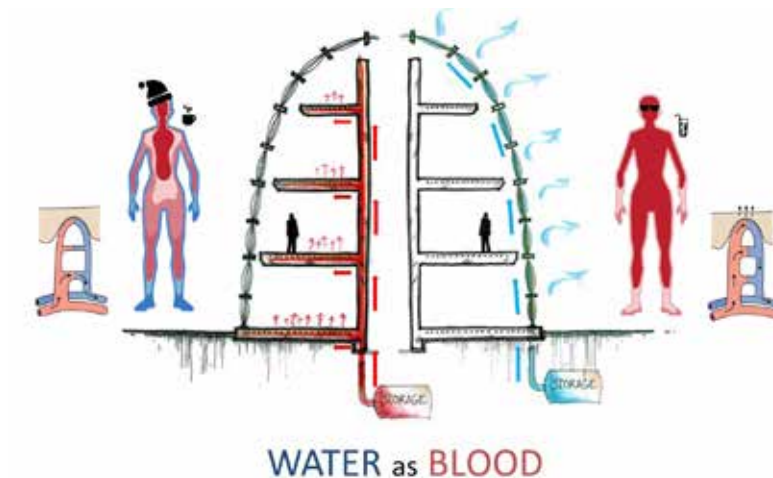

FIG. 2 Conceptual control system: the idea of building's "Blood Circulation", and integrated multi-functional façade components

2.2 MODELING

In this study, the geometry of a standard office room is modeled for daylight (in Radiance and Daysim) and thermal simulation (in Trnsys18) based on the technical standard of VDI 2078:2012-03, for three different climate conditions in Dubai, Tehran and Stuttgart for 2 people (17.50 m², 5.0 m length, 3.5 m width and 3.0 m height) (Figure 3). The south oriented window is 3.3 m by 2.8 m with 9.24 m² area. In this model, the U-value of 0.191 W/m²K is assumed for the external wall.

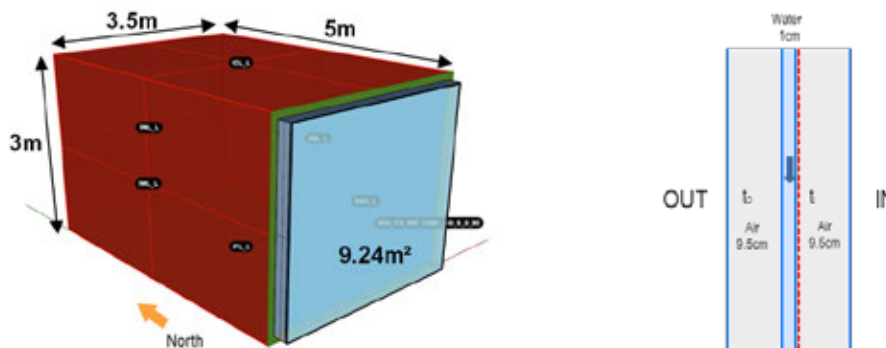

FIG. 3 The geometry of a standard office room and a section of simplified glazing system for main configuration with 1cm water

The glazing system for the base cases is a conventional double glazing window with U-value of 1.1 W/m²K and 60 % SHGC value. The frame fraction is assumed zero and a motorized external movable shading with 70% of shading fraction is active when irradiation values on the inner surface of the window is above 150W/m². The Artificial lighting gain of 10 W/m² is also added to the internal loads by controlling the 300 lux as minimum lux level with no dimming function.

Firstly, six different complex configurations with different shading effects have been generated in LBNL Window7.4 and combined with trnBSDF tool as a detailed window in a Pre-version of TRNSYS18; in order to evaluate the Energy saving performance of the proposed system. The amounts of annual energy demand [kWh/m².a] for heating, cooling and artificial light per square meter and thermal comfort for water-filled configurations have been compared with three base cases (Ganji & Lam, 2016). This study is focused on the impact of different facade configurations on thermal and visual comfort to evaluate the overall performance of system by comparing the energy saving potentials and the comfort conditions side by side.

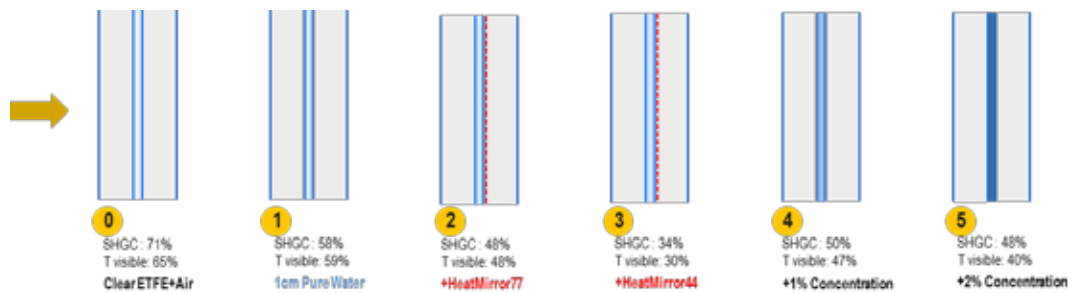

FIG. 4 six different definitions of glazing system, main configuration (number 1) is a multi-layer ETFE cushion with four foils with 0.25mm thickness

As shown in Figure 4, in this study the thickness of water layer is assumed as 1 cm for all six configurations. Configuration 0 (zero) is a conventional multi-layer ETFE cushion with 4 foils with 0.25mm thickness and three cavities and the main configuration (configuration 1) is a multi-layer ETFE cushion, where the middle cavity is filled with 1cm of pure water. The optical properties of systems for other four configurations (configurations 2 to 5) are adjusted by applying reflective coatings (HeatMirror77 and HeatMirror44 for configurations 2 and 3), and dyed water with pigment (1% and 2% of concentration for configurations 4 and 5).

2.3 WATER AS BLOOD AND SUMMER AND WINTER SCENARIOS

Based on the idea of “Water as Blood” and the solar absorption potential of water bladder, in summer, by gaining solar radiation inside water flow and allowing the visible light to transmit through the envelope, the system can effectively avoid the problem of overheating and consequently decrease cooling and electrical loads for artificial lighting due to benefiting from sufficient daylight (Figure 5). All these possible because The Q_{rej} kWh [kWh/a] is the amount of solar heat, which is absorbed by the water bladder (as sunshade) and can be rejected to the earth or radiated to the cold sky overnight and represents cooling potential of the system during summer.

While the sufficient amount of visible light is transmitted to the space, during a winter day, collected heat can be used to support space heating as heat source for a radiant heating slab system or to provide hot water indirectly (Figure 6). During the cold night, the exterior air cavity plays the role of night insulation to reduce the heat loss. The $Q_{collect_kWh}$ [kWh/a] is defined as a representing parameter for passive solar gain potential of the system. This is the amount of useful solar heat gained during winter day in water bladder for different configurations. This amount of energy is simulated based on the average temperature of 35°C, which can be used for heating space during winter.

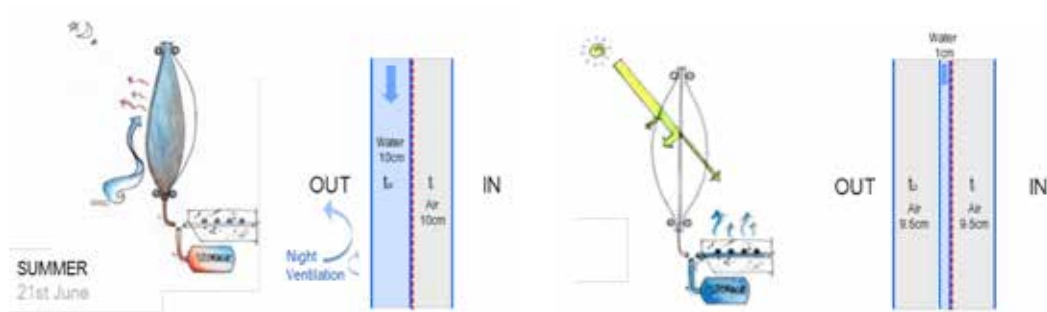

FIG. 5 The Schematic of the basic operation of envelope components; dynamic thermal and optical properties in summer: Left: Summer night (SN), Right: Summer day (SD)

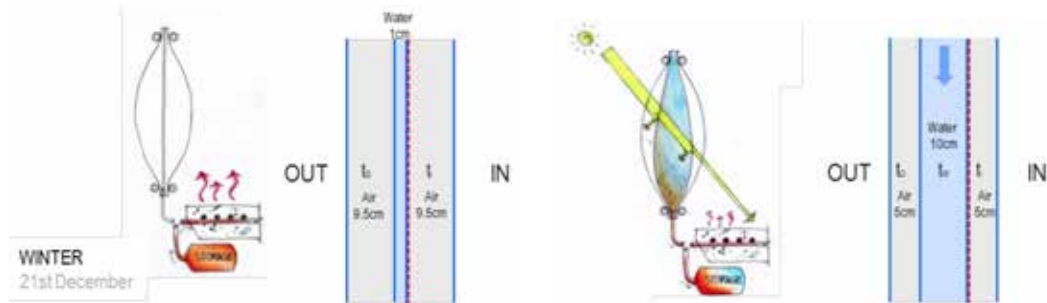

FIG. 6 The Schematic of the basic operation of envelope components; dynamic thermal and optical properties in winter. Left: Winter night (WN), Right: Winter day (WD)

Also the mass flow rate needs to be controlled effectively by the function of water temperature. During a winter day, the outlet temperature of circulated water rises up to 35°C for some heating purposes using in hydronic active slab system or preheating water for domestic hot water usage. During the summer, the cold water is circulated for cooling purposes (15°C) with a higher mass flow rate and the collector works only for pre-heating the domestic hot water and rejecting the excessive heat to the earth.

2.4 ANNUAL DAYLIGHT SIMULATION

Assessing the impact of water layer on visual light transmittance into the space, the configuration zero (0) is compared with number 1 and it is noticeable that adding a layer of pure water (1cm) has a negligible effect on visible light and the sufficient daylight is provided for this case; as it was expected regarding the spectral absorption of water layer in figure 1. Consequently, to evaluate the visual performance of water-filled system, this paper studied the Daylight Autonomy (DA) and Spatial Daylight Autonomy (sDA) for all six configurations. Referring to the annual results (Figure 7), even by using the configuration number 3 (Tvis 30%), Spatial Daylight Autonomy (sDA₇₀₀) remains 84%. This means 84% of the floor area receives at least 700 lux for 50% of the annual occupied hours (office work schedule) in Tehran (at level of 85 cm as work plane height). In some standards the light level requirement for an office room mentioned as 500 or 300 lux. In this study we selected the higher value (700 lux) to visualize the dark corners of room for configuration number 3 and 5 better. This useful daylight utilization has a significant impact on reducing the electricity demand for artificial light which is demonstrated in figure 10.

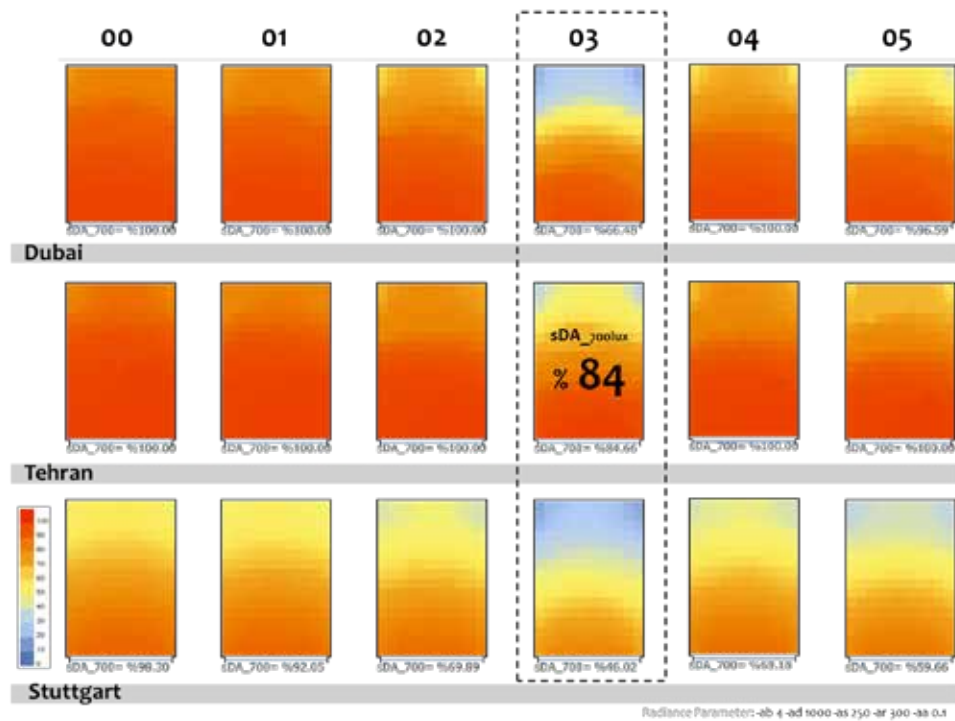

FIG. 7 Daylight Autonomy and Spatial Daylight Autonomy results comparing the impact of water layer with different configurations in Dubai, Tehran, and Stuttgart.

2.5 VISUAL COMFORT; DAYLIGHT GLARE POTENTIAL

In order to complete the assessment of the behaviour of water bladder with different shading effects, in this paper the annual glare predictions are simulated for three configurations (number zero as base case and number 1 and 3) using Daysim via Honeybee, which employs the Daylight Glare Probability (DGP) metric. DGP represents the probability that a person is disturbed by glare and is derived from. Annual DGP uses a simplified method that calculates the vertical illuminance at the eye level as a parameter which can affect the brightness of the space. As the developers mentioned, in this method, glare was divided into four categories: intolerable glare ($DGP \geq 45\%$), disturbing glare ($45\% > DGP \geq 40\%$), perceptible glare ($40\% > DGP \geq 35\%$), and imperceptible glare ($DGP < 35\%$) (Christoffersen, 2006). In this paper, a fish-eye camera was located at the employee eye level (1.20 m above the floor) and facing to the corner between the wall and window. It is also noticeable that for all annual daylight simulation (DA, sDA, and Annual Glare) in this paper, instead of the BSDF file the visible transmittance for different glazing configurations are defined based on the LBNL Window7.4 calculations. In Figure 8, Comparing the annual DGP values and the number of intolerable and disturbing hours in configuration 0 (40% of a year) with number 1 (26%) and 3 (15%), results indicate a noticeable improvement in annual DGP values due to using water bladder with configurations 1 and 3 for Tehran.

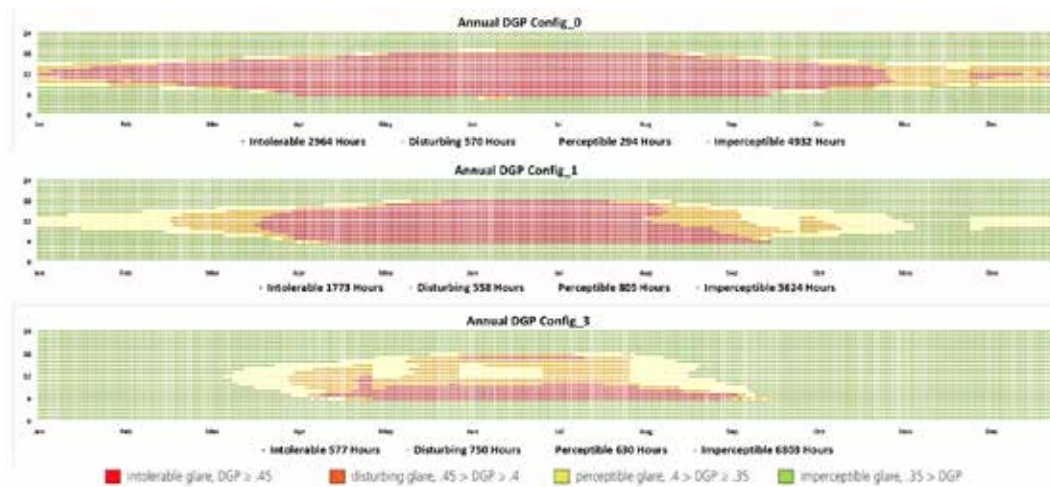

FIG. 8 Annual Daylight Glare Probability values; the impact of water layer in configurations 1 and 3 to improve the visual comfort, Tehran

Finally, this study is complimented by comparing the image based luminance (candela) results for 21st December in Tehran with three configurations number 0, 1, and 3 (Figure 9). In comparison to the glass surfaces with corresponding visible transmittance, the results indicate more uniform distribution of light in room due to simulating the BSDF data (Bidirectional scattering distribution function) generated by LBNL Window. This means in addition to the improvement in annual DGP values in figure 8, using a water bladder (configurations 1 and 3) can have a more significant impact. The main reason of this improvement is the refraction effect of the direct sunlight inside the water layer which can be simulated by using the BSDF Data, included in XML files.

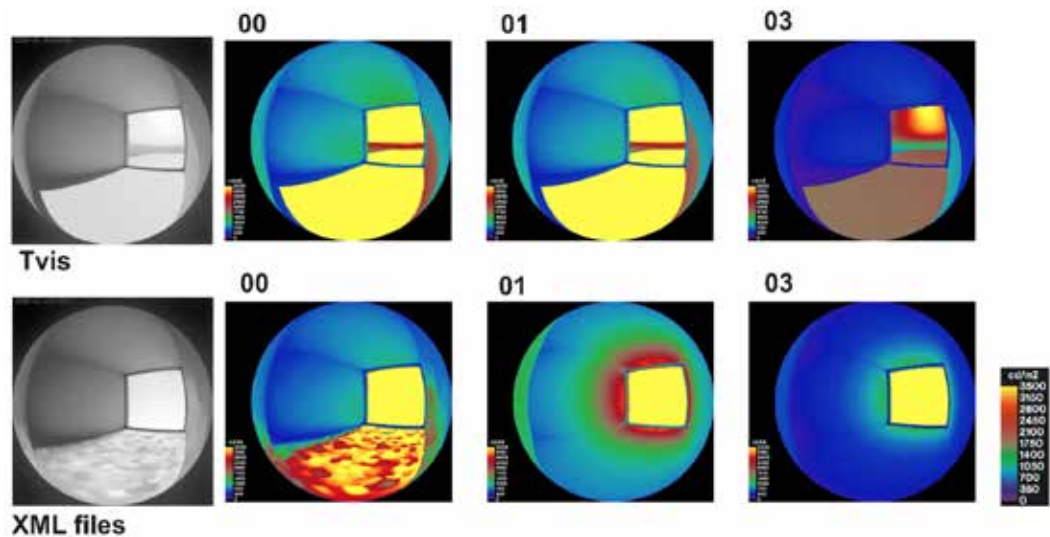

FIG. 9 The image based static simulation results of luminance (candela) comparing the conventional glazing modeling with Tvis with using XML file, 21st December, Tehran

The impact of using water bladder to reduce the glare probability is one of the main potential of the system which can improve the visible comfort and reduce the energy demand simultaneously.

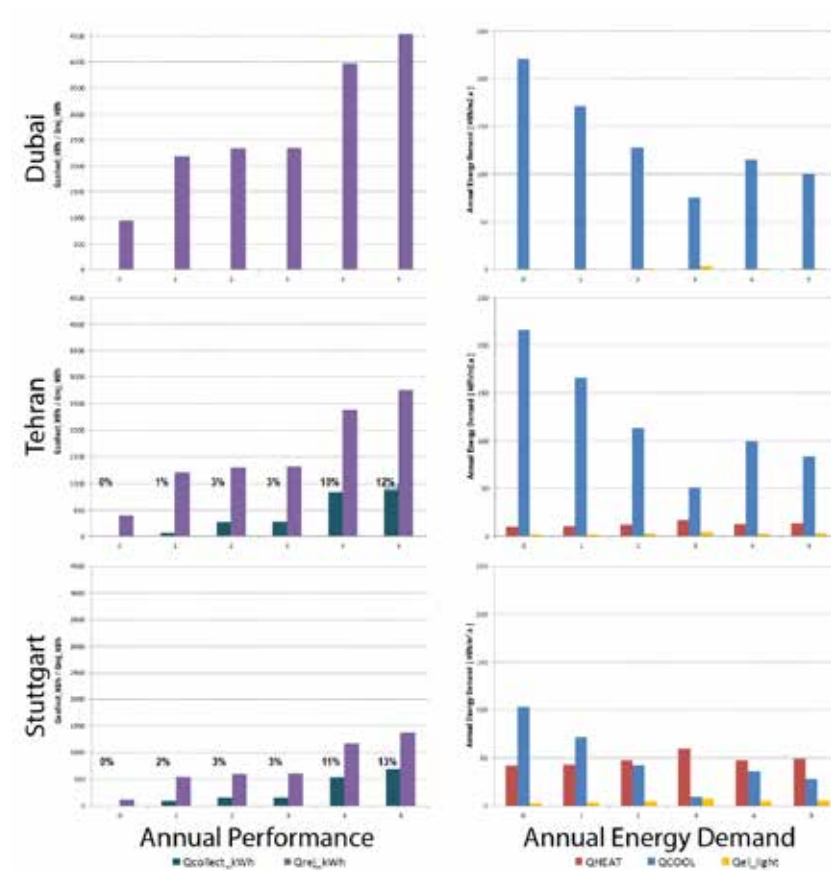

FIG. 10 Annual energy demands and annual performances of six configurations for Dubai, Tehran and Stuttgart.

2.6 ANNUAL THERMAL SIMULATION

Next diagrams (Figure 10) demonstrate the annual performance of six mentioned configurations for three different climates. Right graphs illustrate the annual energy demand [kWh/a]. QHeat_kWh with red bars representing the heating demand, QCool_kWh with blue bars representing the cooling demand and Q_Elec representing the electricity demand for artificial light. In left graphs for Annual Performance, the Qcollect_kWh [kWh/a] is the amount of useful solar heat collected in water bladder during winter for different configurations, with average temperature of 35°C which can be used for heating space during wintertime. This amount of energy shown with dark blue bars. Moreover, the cooling potential of the system during summer is representing by the Qrej_kWh [kWh/a] with purple bars. This is the amount of excessive solar heat absorbed in the water and then rejected to the earth or radiated to the cold sky overnight. In the annual performance graphs, the values of percentage over the blue bars show the efficiency of each configuration as a transparent solar collector. This efficiency is calculated by the amount of useful heat collected in water-filled glazing divided by the total amount of receiving solar radiation on the window surface.

Regarding the Figure 10, in a sunny and hot climate such as Dubai, the significant impact is reducing the annual cooling demand due to using water flow. Configuration number 3, by applying the reflective coatings (HeatMirror44) can reduce the amount of heat transmitted into the room. Consequently, water flow in the bladder can reject the excessive heat to the soil or sky. Configuration 5 is also working by increasing the solar absorption inside the bladder due to the dyeing with 2% of pigment concentration and rejecting this heat. Referring to the annual daylight results and energy demand diagrams, configurations 3 and 5 can potentially provide the sufficient daylight for the space as well as a significant saving in cooling demand.

In Tehran and Stuttgart, high energy saving potential is achieved by reducing the cooling demand in summer and harvesting the solar heat gain in winter. In terms of solar heat gain, configuration numbers 5 and 4 have the best performances (with 12% and 10% of efficiency in Tehran and 13% and 10% in Stuttgart). While the total solar radiation in Tehran is higher than Stuttgart, having a longer wintertime in Stuttgart increases the amount of useful heat gain collected and consequently the efficiency of the system as a transparent collector.

This amount of useful heat collected by with configuration 3, in wintertime can cover 90% of heating demand ($Q_{collect_kWh} = 272 \text{ kWh/a}$) in Teheran, and 15% ($Q_{collect_kWh} = 155 \text{ kWh/a}$) of heating demand in Stuttgart. Using Configuration 5, even can improve the amount of solar heat gain up to 100% and 55% of heating demand respectively for Tehran and Stuttgart.

In the next step, to get a better understanding of the potential of the façade system, the results of configuration number 3 are compared with the base cases with double glazed window and external shading, for three different climates in Figure 11. In comparison to the base cases, water-filled multilayer ETFE cushion can make a significant reduction in energy demand. The results also show that the increasing of shading effect due to reflective films on third layer (Config #3) or dyeing water (Config #4 and 5) can raise the efficiency of the façade component by gaining more heat in water during winter and avoiding risk of overheating in summer.

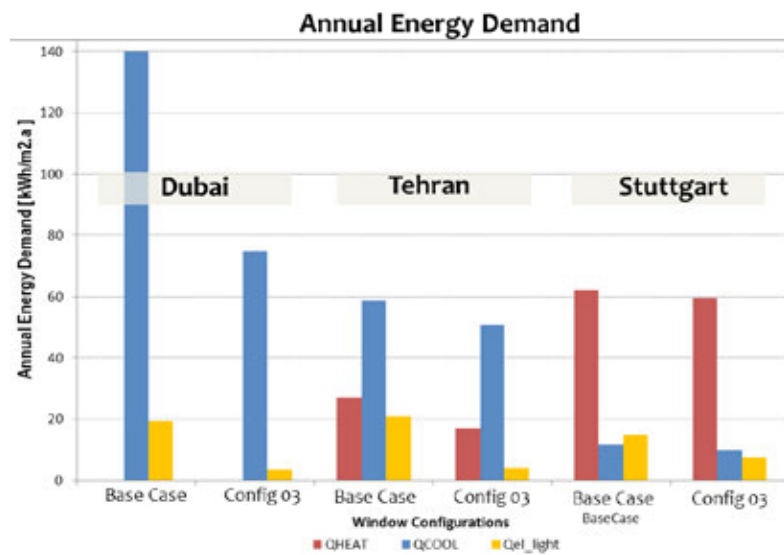

FIG. 11 Annual energy demands base case in comparison with water-filled ETFE cushion (configuration 3)

In order to have a more comprehensive look in evaluating the potentials of a façade system it is very important to take into account the impact of this system in energy saving and comfort, side by side. In Figure 12, The annual thermal comfort for conventional office room (base case) in comparison with water-filled ETFE cushion (configuration 3) is presented over a year for Dubai, Tehran and Stuttgart. Referring to the number of uncomfortable hours ($+1.5 < PMV < +3.5$ and $-3.5 < PMV < -1.5$), it is noticeable that activating the glazing by using water is able to improve the thermal comfort condition. This improvement is more significant for climates with harsh summertime such as Dubai and Tehran by using configurations 3 and 5.

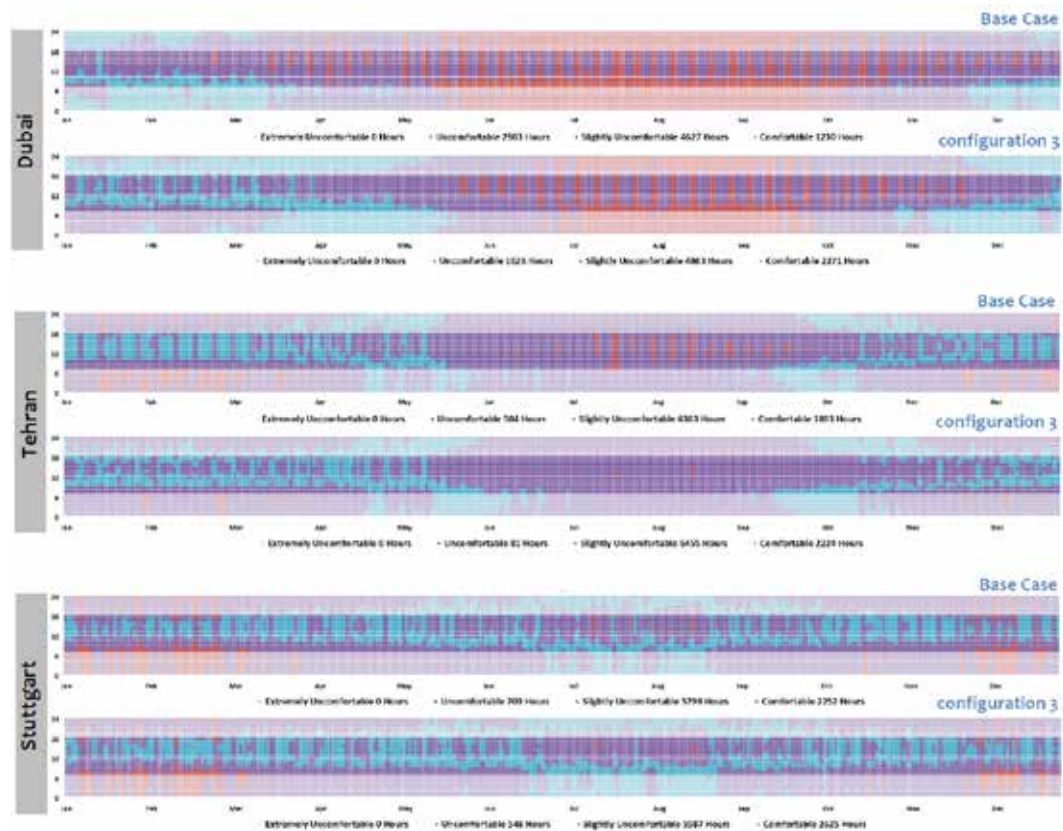

FIG. 12 Annual thermal comfort for conventional office room (base case) in comparison with water-filled ETFE cushion (configuration 3)

3 CONCLUSIONS

As shown in annual energy demands and performances diagrams the performance of each configuration is highly dependent on the climate conditions. The full potential of the dynamic water-filled ETFE cushion and the controlling mechanism of “Building’s Blood Circulation” can only be achieved after evaluating different configurations for each climate through dynamic simulation and finding the most appropriate controlling strategy based on the energy saving potential and visual and thermal comfort together. However, at this stage of research, the performance of each configuration evaluated separately and finding the controlling strategy to switch between the configurations effectively needs to be investigated in next phase of research by choosing the proper

Energy management system. Finally, the proposed façade component as a semi-transparent collector allows some of the mentioned potentials for a south oriented window in different climates:

- Harvesting solar heat by using configuration number 3, and covering the space heating demand: Tehran: 272 kWh/a (91%) and Stuttgart: 155 kWh/a (15%). These values can be increased up to 1000 kWh/a (100%) for Tehran and 695 kWh/a (80%) for Stuttgart by using configuration number 5.
- Reducing the cooling demand due to decreasing the Solar Heat Gain Coefficient. This is possible by absorbing solar radiation in water flow with a constant mass flow rate and rejecting the heat to the soil or by radiating to the cold sky during summer night: (Dubai: 1140 (46%), Tehran: 137 (13%) and Stuttgart: 30 kWh/a (15%)
- Maximizing the daylight utilization and reducing the electricity demand for artificial lighting. (Dubai: 279 (82%), Tehran: 293 (80%) and Stuttgart: 128 kWh/a (49%)
- Improving the visual comfort condition by reducing the number of intolerable and disturbing hours.
- Improving the thermal comfort condition by reducing the number of uncomfortable hours.

Acknowledgements

This research project was done under the support of Transsolar Energietechnik GmbH. Monika Lauster is widely acknowledged for her great effort to invest in cultural diversity and enhance the intercultural dialogue in Transsolar Academy.

References

- Chow, Tin-tai, Chunying Li, and J. A. Clarke. „Numerical prediction of water-flow glazing performance with reflective coating.” In Proceedings of the 12th Conference of International Building Performance Simulation Association, Sydney. 2011.
- Ganji Kheybari, Abolfazl, and Lam, Jochen. “Adaptive Building Envelope: Performative water-filled ETFE cushions” Façade Tectonics Conference, Los Angeles (2016)
- Knippers, Jan, Jan Cremers, Markus Gabler, and Julian Lienhard. „Construction manual for polymers+ membranes.” Institut für internationale Architektur-Dokumentation, München (2011).
- LeCuyer, Annette. ETFE: technology and design. Walter de Gruyter, 2008.
- Otanicar, Todd P., Patrick E. Phelan, and Jay S. Golden. „Optical properties of liquids for direct absorption solar thermal energy systems.” Solar Energy 83, no. 7 (2009): 969-977.
- Ritter, Volker, Christoph Matschi, and Dietrich Schwarz. „Assessment of five control strategies of an adjustable glazing at three different climate zones.” Journal of Facade Design and Engineering Preprint (2015): 1-13.
- Stopper, J., Boeing, F., & Gstoehl, D. (2013). Fluid Glass Façade Elements: Energy Balance of an Office Space with a Fluid Glass Façade. In Proceedings of the Conference sb13 Munich-Implementing Sustainability-Barriers and Chances. Stuttgart Transsolar-Energietechnik GmbH. High comfort low impact. Edited by Monika Lauster. FMO-Publ., 2009.
- Wienold, J., & Christoffersen, J. (2006). Evaluation methods and development of a new glare prediction model for daylight environments with the use of CCD cameras. Energy and buildings, 38(7), 743-757.
- Website: U.S. department of energy, <http://buildingsdatabook.eren.doe.gov/ChapterIntro5.aspx> (accessed July 30, 2016).

Anaerobic domestic waste water treatment coupled to a bioreactor facade for the production of biogas, heat and biomass*

Martin Kerner¹

- 1 SSC Strategic Science Consult GmbH, Beim Alten Gaswerk 5, 22761 Hamburg, tel. +49 40 1899 7966, m.kerner@ssc-hamburg.de

Abstract

In 2015 an anaerobic domestic waste water treatment plant was coupled to a bioreactor façade of an area of 200 m² at a residential building in Hamburg (Germany), known as BIQ - Das Algenhaus. In the BIQ the waste water is treated anaerobically to produce biogas which turns waste water treatment from an energy consuming process to an energy producing process. During treatment more than 90 % of the nitrogen and phosphor are released from the organic waste and remain dissolved in the water after treatment. This nutrient rich water is filtered and UV treated so that all germs and particles are removed and subsequently used to culture the microalgae in the bioreactor façade. For growth (i.e. build up of biomass) the microalgae assimilate the photosynthetic active radiation of 430-720 nm hitting the façade. The remaining radiation is absorbed and converted into heat used in the BIQ for the supply of the residents with warm water. Conversion efficiencies for heat and biomass were 38 % and 10%, respectively. The recycling of the nutrients released during anaerobic treatment of the waste water needs about 10 m² of bioreactorfacade. The algae biomass produced with treated waste water is of high nutritional value and can thus be used to feed fish larvae, shrimps or mussels. The results indicate that the technology for coupling of waste water treatment and bioreactorfacade has reached a state of both technological and economic viability and offers new opportunities for urban development and a choice in underdeveloped countries where only less than 30% of the waste water is treated.

Keywords

bioactive façade, waste water treatment, biogas production, recycling of nutrients, biomass and heat production

* This paper is based on a research project supported by the Bundesministerium für Bildung und Forschung with the code 02WQ1340A.

1 INTRODUCTION

Cities in Asia are undergoing extremely dynamic development – the economy is growing and many people are being drawn from the countryside into towns. But with this huge growth come several challenges: supplying the population with water, food and energy, disposing of wastewater and garbage, and protecting the populace from disasters are all things which need to be safeguarded. At the same time, the people in cities responsible for these matters ought to ensure that natural resources are protected and that the city is offering its citizens a high quality of life. Only in this way can sustainable development be guaranteed long term. Because of the very dynamic situation, this can only succeed if the thinking in sectors is abandoned and innovative solutions are found through synergy between the areas of water, energy and food security.

In the present paper an urban concept is proposed (Figure 1) which is based on the following baselines:

- 1 The waste water is treated at the location of production which makes the transport to waste water treatment plants outside the cities obsolete and thus minimizes logistic investments for the transport system and the energy for transport.
- 2 The waste water is treated anaerobically coupled to biogas production. This turns waste water treatment from an energy consuming process to an energy producing process.
- 3 The anaerobic waste water treatment is coupled to a bioreactor façade which allows to reuse the treated water and the nutrients dissolved therein to produce algae biomass. The algae biomass can be used/sold as feed of highest value for fish larvae, shrimps or mussels.

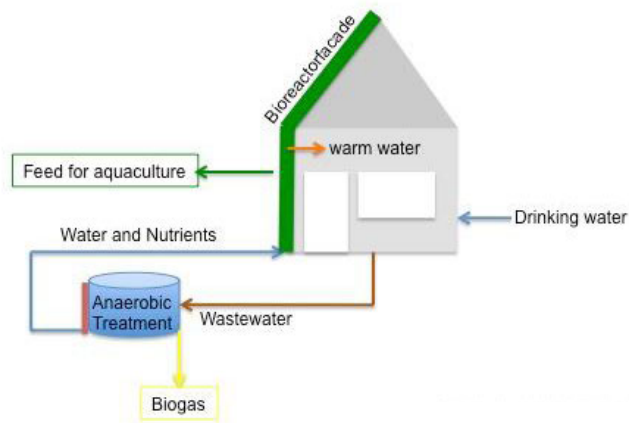

FIG. 1 Urban Water Concept

This concept has been realized in 2013 at a residential building, the BIQ Das Algenhaus, with an active area of 186 m² of bioreactor facade coupled to an anaerobic bioreactor treating 150 L of domestic waste water per day. The production of biogas, heat and biomass with this plant indicate, that this technology is almost ready for a broad and large scale application which will open new possibilities in urban planning and development.

2 EXPERIMENT / RESEARCH

The experiments were done at a residential building situated in Hamburg Wilhelmsburg (Germany) having four floors with a gross living area of 1600 m². In this building which is known as BIQ Das Algenhaus live about 30 persons (<http://www.ssc-hamburg.de>). Attached to the southeast and southwest oriented façades are 129 bioreactors each 300 m x 60 x 15 cm (height x width x depth), covering a total photosynthetic active area of 186 m². The bioreactors form a so called secondary façade that means that they were of curtain type with a distance of about 30 cm to the outer wall of the building. The bioreactors are made of 4 glass layers whereby the two inner glasses have a distance of 20 mm and thus form the space to hold water. The outer glass layers are for insulation and the space between inner and outer layers is therefore filled with argon gas. The water layer was used to culture microalgae (*Acutodesmus obliquus*) up to a cell density of 3 g dry weight L⁻¹ and was thus of dark green color. The solar radiation hitting the façade of the wavelengths between 430-680 nm (i.e. photosynthetic active radiation) was converted by the microalgae into biomass while the rest was physically converted into heat. Both algae biomass and heat were continuously harvested from the culture medium in order to obtain the temperature below a value of 35 °C critical for the algae. The heat was used to supply the residents with hot water. In order to obtain high growth of the microalgae CO₂ and nutrients were continuously added to the culture medium. The CO₂ was derived from the flue gas of a gas burner, which was enriched by a method based on a membrane of a high solubility for CO₂ to obtain a concentration of about 30 vol % before addition (Wolff et al. 2015). The nutrients and the water were derived from an anaerobic biogas plant to which the bioreactorfaçade was coupled.

The biogas plant consisted of a 1000 L gas tight stainless steel vessel into which a volume of 100 L/d of the domestic waste water was added and treated anaerobically at 35°C. Simultaneously, 100 L/d of the treated waste water was filtered through a ceramic membrane of a pore size of 36 nm and subsequently UV treated for sterilization purposes and subsequently used as culture medium in the bioreactor façade. Because in contrast to an aerobic treatment the nutrients in the organic waste become mineralized and remain dissolved, the treated waste water was rich in N and P and thus favorable as a nutrient source to feed the microalgae.

The coupled system of bioreactorfaçade and biogas plant was established in March 2016 and runs automatically from that on. The parameters ruling fermentation and algae production were determined by sensors and recorded in 5 minute intervals. Results shown below were based on these data and refer to overall performance of the coupled system.

3 RESULTS

Performance of the bioreactorfacade



FIG. 2 Bioreactorfacade at the BIQ Das Algenhaus

Figure 2 shows the bioreactorfacade at the BIQ Das Algenhaus. The photobioreactors are filled with culture medium in which microalgae grow using the sunlight as an energy source. The efficiency of this growth can be directly correlated to the intensity of the radiation hitting the facade and given with a conversion efficiency value of 10 %. This means that of 100% radiation 10 % is converted into algae biomass.

A heat conversion efficiency of the bioreactorfacade was determined from the gain of heat at BIQ. As can be seen on Figure 3 the conversion efficiency reached during the period March to October a mean of about 45 %. This is lower than conventional solar thermal devices which reach about 65 %. Owing to that the microalgae (*Acutodesmus obliquus*) were cultured at their optimum conditions the temperature of the heat gained never exceeded 35 °C. In order to use this heat for supplying hot water for the residents of the building temperature was increased with a heat pump to 50-60 °C.

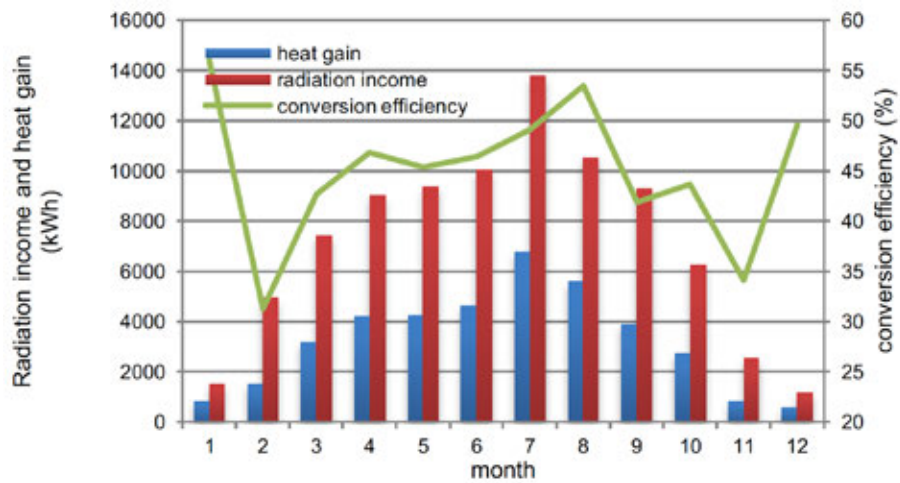

FIG. 3 Conversion efficiency of the bioreactor façade of an active area of 186 m² at the BIQ during different months in 2014 calculated from the ratio of radiation income and heat gain.

Owing to that heat is generally produced during daytime when there is demand for warm water, the best performance can be obtained if the heat covers the total heat demand of the building. As can be seen from figure 3 this was the case during may 2016, when warm water consumption in BIQ was fully covered by the heat produced in the façade.

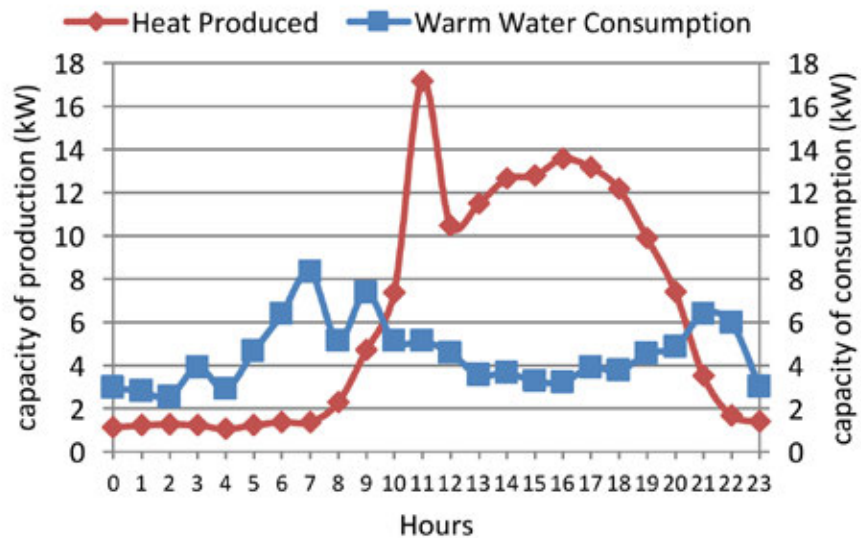

FIG. 4 Mean daily variation of the heat capacity produced in the bioreactorfacade of an active surface of 186 m² and the capacity needed to produce the warm water consumed by the residents of the building BIQ Das Algenhaus in May 2016 measured by heat meters and given in kW.

Performance of the anaerobic waste water treatment

Table 1 shows the results of the anaerobic treatment of the domestic waste water produced in the BIQ given as means for the period between March and October 2016. As can be seen from the input parameters the waste water in the BIQ did not differ significantly from that described in literature (DWA 2008). The same is true for the efficiency of anaerobic degradation which includes 85 % of the organic matter in the waste water (Hissel & Hillenbrand 2010). Coupled to this was a biogas formation of 35 Liter per capita/d containing methane at a concentration of 70 vol.%. A new and important result with respect to a coupling of waste water treatment and algae cultivation in a bioreactorfacade was, that 90 % of the nitrogen and 95 % of the phosphorous present in the organic matter became dissolved after treatment and thus available in the permeate as nutrients for microalgae.

INPUT WASTE WATER (WW)	VALUE
Type of WW	total domestic
Volume (L/cap/d)	152
Particulate matter (g dry weight/cap/d)	95
Chemical Oxygen Demand – COD (g/cap/d)	70
total nitrogen (gN/cap/d)	11,9
total phosphorous (g P/cap/d)	1,8
ANAEROBIC DEGRADATION	VALUE
Retention time (days)	1-5
Decrease in COD (%)	85
Decrease in particulate matter (%)	80
dissolved N in permeate (g N/cap/d)	10,7
dissolved P in permeate (g P/cap/d)	1,7
pH value of permeate	6,8
Availability of dissolved N for algae (%)	100
Availability of dissolved P for algae (%)	100
elimination of trace metals	75-92
Elimination of organic contaminants	Nonylphenoethoxylats to NP = 100, 88% of NP remains in sewage sludge EE2 by 81% remains in sewage sludge
Biogas formation(L/cap/d)	35
CH ₄ in Biogas(%)	70
CO ₂ in Biogas (%)	30

TABLE 1 Results from anaerobic treatment of domestic waste water obtained in the BIQ Das Algenhaus as means during March to October 2016.

In order to determine the area of façade needed to recycle the nutrients produced per capita, the conversion efficiencies determined for the bioreactorfaçade of the BIQ was used to calculate biomass production for the conditions of solar radiation at HonKong. From the annual biomass production the N and P demands of the microalgae based on Redfield Ratios (Geider & La Roche 2002) were calculated (Table 2). Based on the data of the release of N and P during anaerobic waste water treatment obtained at BIQ (Table 1) the active area of bioreactorfaçade necessary to recycle these was calculated. As can be seen from Table 2, to recycle the nitrogen (N) and phosphate (P) released from the treated waste water of one person about 5 and 12 m² of active area are needed, respectively.

CONDITION AND FUNCTION	VALUE
Global radiation Hong Kong (kWh/m ² /a)	1466
Radiation at SE/SW-façade (kWh/m ² /a)	733
Energy conversion efficiency for heat (%)	38
Energy conversion efficiency for biomass (%)	10
Biomass production (kg/m ² /a)	10
Heat production (kWh/m ² /a)	279
N demand (gN/m ² /a)	770
P demand (gP/m ² /a)	48

Size of façade for recycling nutrients from waste water

Recycling annual P (m ² /500 cap)	6095
Recycling annual N (m ² /500 cap)	2537
Façade area for P recycling (m ² /cap)	12
Façade area for N recycling (m ² /cap)	5

TABLE 2 Calculation of the N and P needed for the production of biomass at a bioreactorfaçade in Hong Kong and the area of active bioreactorfaçade necessary to recycle the nutrients from the waste water per capita.

Cost benefit calculation of a coupled system of anaerobic waste water treatment and bioreactorfacade

TYPE OF COST	EURO	ACTION	EURO
Investment (Euro)	2.500.000	Planning	50000
Operational Costs per year		Realisation	350000
Energy costs (0,27 Euro/kWh)	14.844	Costs for construction (Euro)	400000
Maintainance	5.000	Operational costs (Euro/year)	
Replacement	3.000	Replacement	2500
Total operational costs (Euro/a)	22.844	Maintainance	2500
Outcome per year		Energy	3000
Biomass production (t/a)	29	Total operation (Euro/a)	8000
Heat production (MWh/a)	696	Outcome per year	
CO ₂ Scavening (t/a)	88	Treated waste water (m ³ /a)	20440
Revenues per year		N-Recovery (kgN/a)	1953
from Biomass (5 Euro/kg)	146.608	P-Recovery (kgP/a)	292
from Heat (5 cent/kWh)	34.820	Biogas formation (m ³ /a)	6388
from CO ₂ Scavening (30 Euro/t)	2.639	Revenues per year	
Total revenues (Euro/a)	184.067	from treatment (Euro/a)	42720
Return of invest (%/a)	6	from Biogas (Euro/a)	4698
		from P (Euro/a)	290
		Total revenues (Euro/a)	47707
		Return of invest (%/a)	10
		Income from water reuse (Euro/a)	?

TABLE 3 Cost-benefit calculations for an bioreactorfacade of 3000 m² of active area (left table) and the anaerobic treatment plant covering the waste water of 500 persons adapted to produce the nutrients and water necessary to cover the demand for biomass production (right table) at Hong Hong. The costs and the benefits are based on german prices.

When comparing costs of anaerobic treatment with a conventional aerobic treatment it has to be considered that the anaerobic treatment will be done decentralized at the location where the waste water is produced. Hence, tubings, pumps and infrastructure otherwise necessary become obsolete.

Furthermore, cost balance should take into account the coupling of waste water treatment and microalgae production. Such a coupling has the advantage of a direct and complete recycling and reuse of the nutrients (N, P) released during anaerobic treatment.

4 CONCLUSIONS

As the technology for a coupling of bioreactor facade and anaerobic waste water treatment were tested at an industrial scale at BIQ Das Algenhaus for about one year it can be considered as proven and reliable. The coupling offers the advantage to recycle the nutrients and the water after treatment at an astonishing small façade area of about 10 m² per capita and thus the technology is of high interest for all those locations where a water treatment is not established or can only be established at high costs. A return of invest of about 10 % was calculated for a large plant of 3000 m² of active façade area and the treatment of the waste water of 500 persons considering german prices. Thus, the technology is economically viable and thus of interest for application on a large scale.

Acknowledgments

This paper is based on a research project supported by the Bundesministerium für Bildung und Forschung with the code 02WQ1340A.

References

- DWA (2008): Neuartige Sanitärsysteme. DWA-Themen, DWA, Hennef.
- Geider, R. and La Roche, J. 2002. Redfield revisited: variability of C:N:P in marine microalgae and its biochemical basis, *European Journal of Phycology*, 37:1, 1-17
- Hiessl, H. und Hillenbrand, T. 2010. Dezentrales Urbanes InfrastrukturSystem DEUS 21. Abschlussbericht Fraunhofer-Institut für System- und Innovationsforschung
- Wolff, T., Brinkmann, T., Kerner, M., Hindersin, S. (2015). CO₂ Enrichment from Flue Gas for the Cultivation of Algae – A field test. *Greenhouse gases- Science and Technology* 5:1–8; DOI: 10.1002/ghg

Free-Form 2.0 – Building prefabricated segmented concrete free-form Shells

Alexander Stahr¹, Martin Dembski², Michael Theuer³, Lars Janke⁴

- 1 Chair of Structural Design, Department of Architecture and Social studies, Leipzig University of applied Sciences, Karl-Liebknecht Straße 132, 04277 Leipzig, Germany, Tel.: +49 341 3076-6263, Fax: +49 341 3076-6252, alexander.stahr@htwk-leipzig.de
- 2 Chair of Structural Design, Department of Architecture and Social studies, Leipzig University of applied Sciences, Karl-Liebknecht Straße 132, 04277 Leipzig, Germany, Tel.: +49 341 3076-8897, Fax: +49 341 3076-6252, martin.dembski@htwk-leipzig.de
- 3 Chair of Structural Design, Department of Architecture and Social studies, Leipzig University of applied Sciences, Karl-Liebknecht Straße 132, 04277 Leipzig, Germany, Tel.: +49 341 3076-8897, Fax: +49 341 3076-6252, michael.theuer@htwk-leipzig.de
- 4 Ingenieurbüro Lars Janke, Friedrich-Franz-Straße 19, 14770 Brandenburg a. d. Havel, Germany, Tel.: +49 3381 2692-7110, lj@larsjanke.de

Abstract

Since the last decades modern architecture is increasingly determined by the trend to produce organic building designs. While some just thinking of futuristic blobs, organic free-form shapes also contain the potential to be more efficient in purposes of energy, material usage and structural impact than orthogonal or polygonal boxes. The best examples are shapes of living nature, nearly everything is a free-form geometry being form and material optimized for certain conditions.

Nevertheless the production of such unique shapes in the building industry is nowadays still awkward, time-consuming and material-intensive. With this in mind the research project "fhoch3", as a cooperation of associates from manufacturing and science, deals with the development of material-efficient, intelligent shaped (Höbinger, Pottmann, Vouga, Wallner, Columbia Univ., Evolute, Kaust, TU Wien, 2012), segmented and prefabricated concrete shells for primary structural purposes without or at least with extremely less sub-structure and reusable or recyclable formworks. The basic idea how to simplify and optimize the building process of those free-form shells is to think different, not from design to fabrication, but from assembly and fabrication to design.

Because of this a close cooperation between design and production is necessary to use a concept which is adaptable in all design, analysis and production stages.

For this reason a parametric model was created, combining all needed steps in one place.

This parametric master application analyses the geometry, tiles the free-form according to its curvature, adds connections, interacts with a structural software analysing the segmented result and if necessary adjusts the design according to the analysis results, loops the steps if necessary and creates finally data for production. The Result is a nearly full automated algorithm for building segmented resource-efficient free-form shells.

Keywords

architectural geometry, assembly, cement based, concrete, construction, digital, fabrication, formwork, free form, optimization, resource-efficient, seam, segmentation, shell, sub-structure, tiling, free-form analysis, parametric model, interoperability

1 INTRODUCTION

A free-form shell describes a thin-walled areal construction element whose biaxial curvature doesn't follow any analytic geometry. The curvature of the shell has the potential to enable highly efficient structural performance which can't be achieved with conventional mostly bending claimed constructions. This was the reason why double curved shells were the only possibility to cover large spans, for a long time.



FIG. 1 Pantheon Ceiling

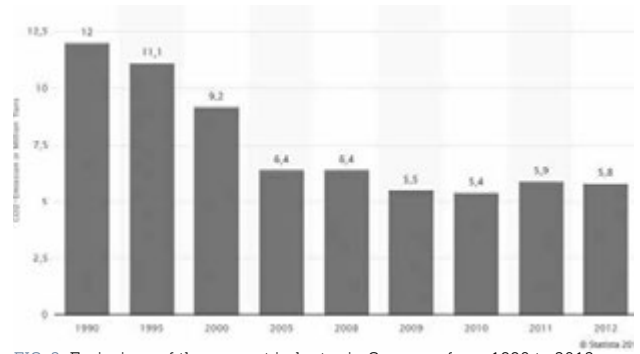

FIG. 2 Emissions of the cement industry in Germany from 1990 to 2012 (VDZ, 2013)

The industrialization of the building industry, the ongoing development of new building materials, like reinforced concrete, the changes in material costs and costs of human resources and the growth of prefabrication and logistical improvements caused that larger material costs were tolerated for the reduction of workloads. So the frugal but challenging shell constructions were replaced by planar and simple to build, material intensive, structures.

Indeed the building sector gains a lot of attention in questions of lifecycle examination, grey energy and emission capabilities in the last decades. Since concrete is the dominant building material of the modern society its almost excessive use is disturbing when you are aware of the fact that it is a transient material.

Statistically, one cubic meter concrete per human and year is produced (Turner, 2011). Therefore 250 kg, in combination with steel reinforcement even 440 kg, carbon dioxide is generated. Thus the production of one cubic meter concrete (Althaus, Lehmann, 2011) causes as much emissions as a modern German average car (KBA, 2015) driving 2000 kilometers.

Therefore it is important how to deal with concrete as a material in the future. From this point of view concrete shell structures have a good long-term ecological impact, because the permanent structure consumes fewer resources. But the most important obstacle for the construction of large concrete shells is the need of a falsework with a formwork, consisting mostly of wooden materials. This needed additional and disposable construction produces 30-40% of the total costs of the whole shell that is why the development for cost-efficient technological production solutions continues. In this context the proposed development is located.

The idea is to work backwards, not from design to fabrication but using the knowledge from assembly and fabrication to generate an overall concept for realizing the design. Based on this, the idea of a two layered shell was developed.

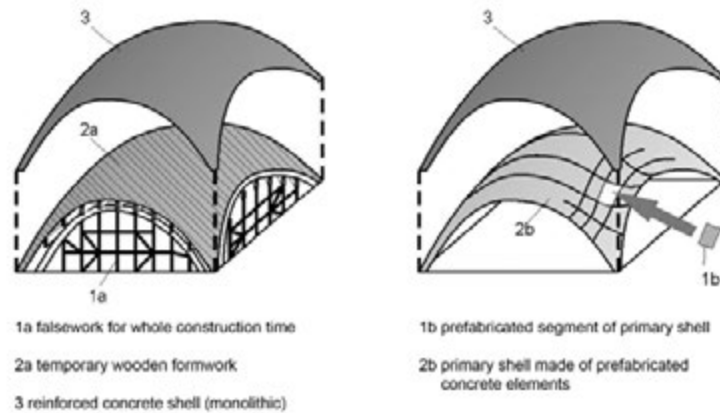

FIG. 3 Principal illustration of the building process (left | traditional, right | new concept)

Thereby the first layer is made of a segmented prefabricated concrete shell used as permanent formwork. The single shell elements are connected with customized connectors enabling the chance of a balanced cantilevered construction to reduce or even to avoid the falsework costs. When the first layer is completely assembled a second layer of cast-in-place concrete with fiber reinforcement is added on top. For this basic approach we took a closer look to the processing routine of concrete shell projects to create a planning and production sequence.

2 METHODOLOGY / SEQUENCE

The sequence provides a guideline combining digital and physical working steps. The digital part, which will be explained in the following chapters, is a semi-automatic approach which includes the analysis of the shape, the segmentation and connection procedure and the structural analysis of the segmentation result. If necessary the shape will be adjusted and the steps will loop again using the adjusted shape.

The physical part is directly connected to the prior digital one. Based on the resulting shape, the fabrication data will be generated, which can be used for milling and formwork manufacturing. The whole production is, as a prefabrication process, completely independent from outdoor conditions. After the completion of the segments they are positioned by crane and assembled via the connectors by hand. At last the reinforcement will be added together with the second layer of site-mixed concrete to enable the actual structural shell effect.

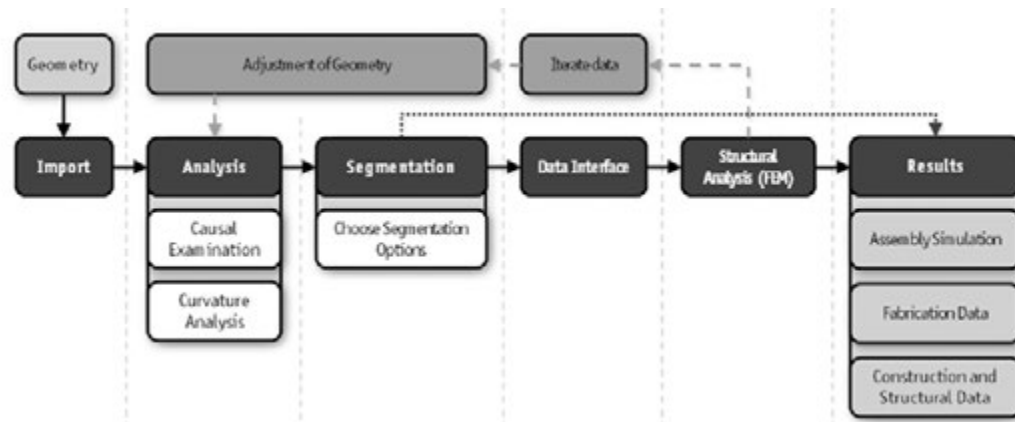

FIG. 4 Concept of the digital Workaround (schematic functionality of the parametric Model)

3 DIGITAL WORKAROUND

In order to consider different free-form shapes, as well as generating a customizable segmentation and connection solution for different designs and in addition to this, still be able to ensure a simple and low-tolerance exchange with external FE and manufacturing software a semi-automated and parametric component object model software solution, short COM, in our case, based on McNeel's Rhinoceros 3D CAD software as well as ASCII based text files and Dlubal's RFEM software, has been developed. Certainly the principal and functionality of this process is adaptable for nearly any other software combination too, having an analogical functional range.

3.1 FUNDAMENTAL DATA

After some preliminary tolerance and data exchange tests the basic data was specified to NURB geometry to ensure the precision and continuity of the model during all steps of the project. In particular the exchange between the used CAD, analysis and fabrication software resulted in certain cases, if meshes were used, in some fragmental errors, higher inaccuracies and various other issues, like remeshing problems in the FEM software, missing polygons as a result of the software specific export and import procedure, not supported polygon counts and angle interpretation issues of single polygon faces which could not be solved in a short time. But in future both mesh and NURB geometries will be possible to use.

3.2 ANALYSING FREE-FORM SHAPES

The first step in the digital workaround is a causal examination of the provided model. This means the geometry is tested for certain criteria's concerning surface data, total size, slope, etc. to examine if the geometry fits the boundary conditions of the algorithm. Furthermore this procedure is necessary to ensure that the segments are buildable and match the limitations of reinforced concrete processing like fluidity on slopes.

In the next step, if the model is valid, the curvature of the model will be analyzed by a new developed method, which is similar to the Gaussian curvature. The so called "local estimated curvature" or "LE curvature" is based on tangential circles which can be created at any UVW coordinate in the, "local", UVW coordinate system of the geometry.

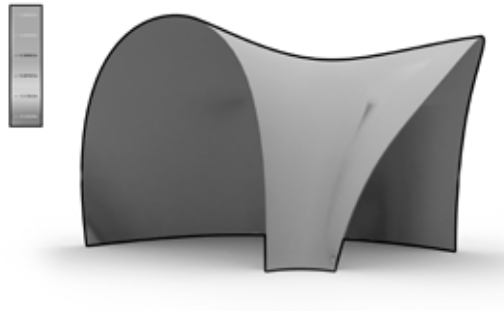

FIG. 5 Local Estimated Curvature Analysis of a Freeform Shell

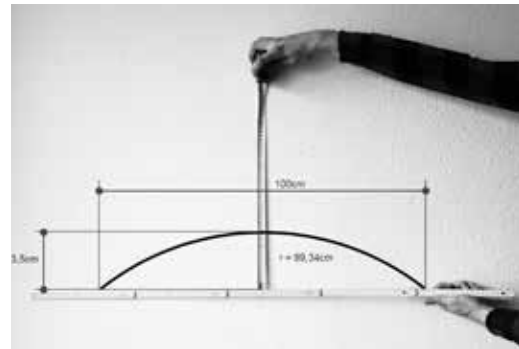

FIG. 6 Local Estimated Curvature - Visualization of Values

To determine the “LE curvature value” the radius of the tangential circle is used to calculate the height of an arc with the circle’s radius and a defined chord length, which is in our case always specified as one meter. Thereby the arc height becomes the defining value of the “LE curvature”. However, since the radius of the tangential circle at one point on a free-form surface depends also on the direction there can be infinite different LE curvature values at one location of the surface at the same time. To limit this to a rational quantity the NURBS local UVW coordinate system at the investigated point is used to define two reasonable perpendicular directions. For the analysis both directions, U and V, can be considered separately, as sum or as an average of both. Based on this method it is possible, even for amateurs, to understand very fast the shape and local dimensions of a complex curved virtual free-form without the need of a physical model or specific knowledge. There are just two rulers or measuring tapes needed to visualize this directly in front of you. The result of the LE curvature is not only used for visualizing and understanding the free-form shape it is also needed for a curvature based segmentation.

3.3 SEGMENTATION

While the free-form segmentation process is primarily based on curvature values the single segments need to be dimensioned referenced on the provided construction space and logistical limitations, too. As a result of this the maximum bounding size of one segment is limited to a length and width of 2m and a height of 1m, while the material thickness is currently limited to 4 to 5cm, due to the handling of the single segments, the necessary prescribed maximum grain impact of the used concrete and the necessary minimum reinforcement cover according to DIN EN 206-1 / DIN 1045-2. To ensure this, each segment is checked by calculating and measuring the minimal bounding box during the segmentation process and if necessary the segmentation is adjusted.

Furthermore the segmentation type has also a large impact on the following steps. After some research it appears that some segmentations have benefits in some fields over others. While triangle based, hexagonal, polygonal or some freeform segmentations seem to be more structural efficient than a rectangular or quadrangular tiling it seems to behave exactly reversed when it comes to costs and production. Here you can draw again conclusions to the living nature. Since the partitions which can be found here also reflect the observed structural-form paradigm (Thompson, 1945).



FIG. 7 Turtle Shell with polygonal Segmentation

However, since the production of the building industry is mainly designed for rectangular shapes so far, other forms are difficult, more expensive and uneconomical to produce, even if this is at the expense of the geometrical and functional efficiency. Despite the positive properties of non-rectangular shapes, four-sided ones have another distinct advantage over many other shapes. The advantage is that, except for the last tile, only two edges must be connected in the assembly process, which simplifies the assembling and the on-site calibration of the elements a lot.

For example in a hexagonal subdivision it would be three edges that need to be aligned and assembled simultaneously.

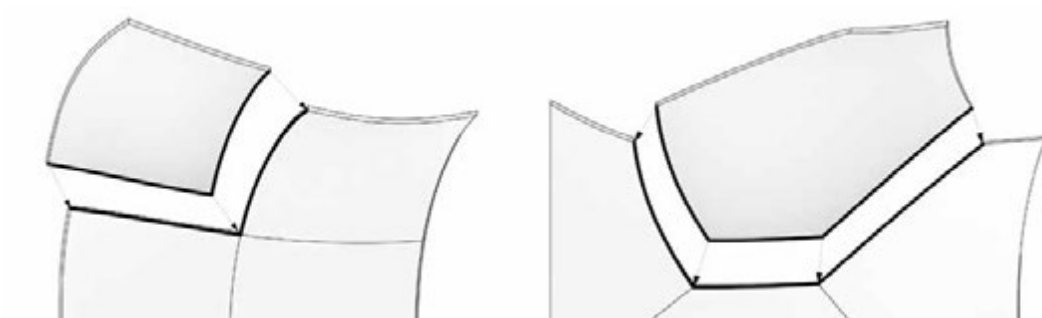

FIG. 8 Segmentation dependent edge assembly (left | quadrangular Segmentation, right | hexagonal Segmentation)

Due to the aforementioned findings and the financial and technical feasibility, the quadrilateral grid was used in the further course. In further division experiments it was determined that an offset of the quadrilateral division by half of the edge length in every second row of the segmentation grid also leads to a better overall structural effect. Following this method shatters the continuous gaps and generates intersection points at the vertices of each element where only three segments meet, instead of four. So the gap diagram turns, at least in one direction, from a continuous intersecting curve grid, generating X-shaped crossing points, to a stretcher bond like pattern with T-shaped crossing points. This, in connection with the double curved geometry of the elements and the therefore inconsistent aligned connectors, increases the stability of the primary shell.

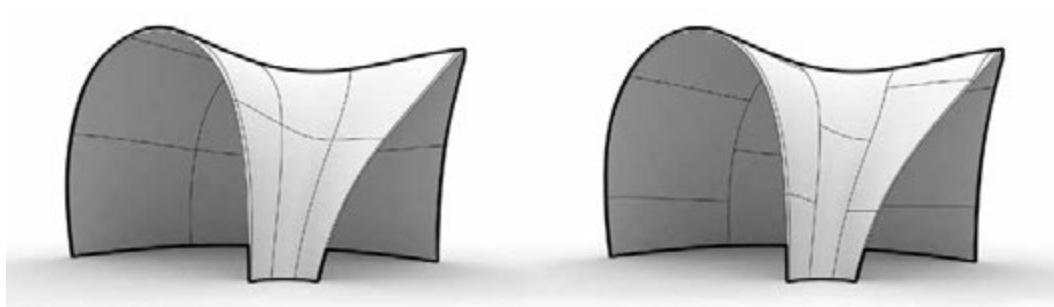

FIG. 9 quadrangular Segmentation (left | Grid, right | offseted Grid)

3.4 THE GAP

Due to the advantages in production and assembly, the segment edges are always formed in local normal direction of the overall shape. This generates double-curved side faces in the final segment geometry. But despite that and after some research no additional formwork or complicated profiles are necessary to produce the elements lateral surfaces. For fabrication it is just necessary to fix straight batten-like pieces, which fit to the shape by bending and twisting, to the double-curved base formwork to produce the also double-curved exact sides of the segments. Furthermore by using the local normal direction time-consuming processes of fitting the connectors and alignment of the segments during the assembly process are reduced to a minimum.

3.5 CONNECTION

The position of the connectors, the holes and the sleeves are determined by the parametric model through local point coordinates on the shell. But to connect the segments to each other and to allow a fine adjustment, as well as a cantilevering construction during assembly in a way that additional substructures can be reduced, it was necessary to develop a new connection element combining all of these claims. The result of this development is the so called double-cross-connector, or shortly DCC. The DCC consists out of two overlapping cross-like metal structures that are centrally connected to each other, creating an axis of rotation, whereby the connector can be adjusted to different curvature situations. Through a sum of six holes, in the attached flat plate-like end-pieces and the side-arms, the DCC is bolted to the cast-in sleeves of the segments. So the segments of the primary shell are friction-locked to each other.

By three fixing screws, the connector is immovably attached to the segment. While slots provide the necessary compensation of the manufacturing- and assembly-tolerance. With this newly developed system a cantilevered construction of one segment is possible. Therefore a reduction of about 10% and more, depending on the base freeform geometry, of the substructure is possible in comparison to traditionally shell building methods.

Furthermore depending on the necessity it is possible to use the DCC connection system above the primary shell, as a lost construction element being poured into the site concrete of the secondary shell, or below the primary shell, as a reusable system being disassembled after the secondary shell is finished.

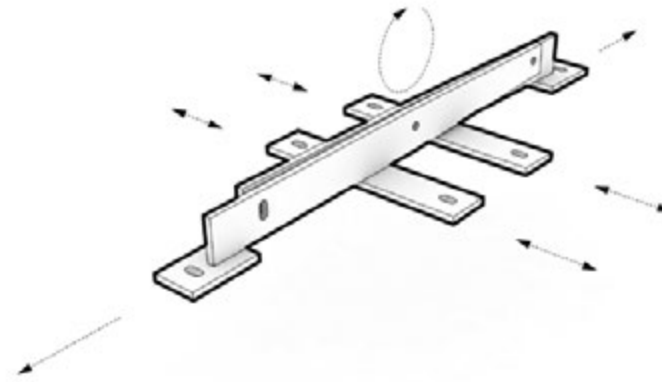

FIG. 10 Double-Cross-Connector (DCC)

3.6 STRUCTURAL ANALYSIS

After the segmentation and the position of the DCC connectors have been adjusted for the freeform shell in the digital workaround, the current result of the parametric model is transferred via a self-developed interface to a FEM software. Using an algorithm, the interface decomposes all geometries and information into their components and converts them into rudimentary data. The result is a small text-only file that is based on simple tables which can be used therefore non-software-specifically.

	A	B	C	D	E	F	G	H
1	Node No.	ID (Weight)	CS	Ref Obj.No. (SurfaceNo)	x	y	z	Comment
2	1	1	Cartesian	1	9.66828	7.905094	1.606919	CtrlLine
3	2	1	Cartesian	1	9.631959	7.928198	1.48169	CtrlLine
4	3	1	Cartesian	1	9.57087	7.964844	1.224597	CtrlLine
5	4	1	Cartesian	1	9.507389	8.000097	0.825147	CtrlLine
6	5	1	Cartesian	1	9.467339	8.021001	0.416558	CtrlLine
7	6	1	Cartesian	1	9.453876	8.027635	0.139455	CtrlLine
8	7	1	Cartesian	1	9.45	8.029515	0	CtrlLine
9	8	1	Cartesian	1	9.559367	7.906466	1.606132	CtrlLine
10	9	1	Cartesian	1	9.521792	7.933761	1.480928	CtrlSurf
11	10	1	Cartesian	1	9.458376	7.979261	1.223815	CtrlSurf
12	11	1	Cartesian	1	9.391944	8.028671	0.824407	CtrlSurf
13	12	1	Cartesian	1	9.349371	8.064559	0.416025	CtrlSurf

FIG. 11 CAD-FEM Interface and vice versa

This file contains all raw information which is necessary for structural calculations. The geometry itself is also included and will be rebuilt inside the FEM software after it is imported. Thus the transmitted model matches, in the usual CAD tolerance range, exactly the previously processed model from the parametric CAD environment. This exact handover guarantees a return of the data, allowing possible necessary adaptation of the design. Now the model will be analysed within the used FEM software and returned in the same way to the parametric model, including the results of the analysis.

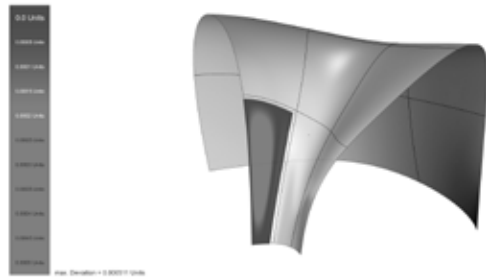

FIG. 12 CAD-FEM Tolerance Comparison

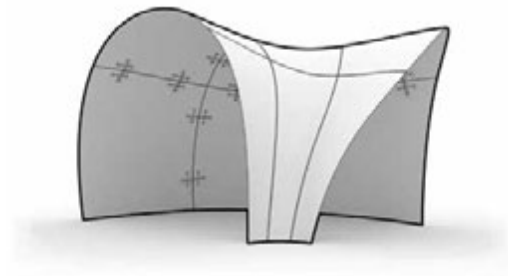

FIG. 13 Prototype Shell

3.7 INTEGRATE CHANGES

Depending on the results of structural analysis, the shape of the original geometry, the segmentation, the connector dimensions, or a mixture of all these parameters are adjusted and if necessary iterate again to the previous described sequence. This will be repeated until a satisfied result is discovered.

3.8 FABRICATION DATA

In the last step of the digital workaround the manufacturing data is generated from the re-imported or adapted model data. The precalculated minimal bounding boxes, from the segmentation process, of each element are now used to orient the segments in a high efficient and economical way, so that as less material as possible and the shortest amount of cutting time is needed to produce the formworks while the alignment of the formworks for the final casting is considered based on information of our operating partner. Afterwards the prepared segment data is transferred to the concrete factory using it for milling the final formwork of each segment.

The data includes, besides the geometry of each segment, the position information and size of the sleeves for the connectors which get embed in concrete. In addition to this the dimensions of the connectors for purposes of production can be displayed too. Finally an assembly plan containing the order of construction is generated.



FIG. 14 Concrete Formwork Fabrication with a 5axis CNC Milling machine

4 RESULTS

The basic idea dividing a shell into a primary shell, which is used as a lost formwork and a secondary shell which is reinforced and poured on top of the primary shell on site seems to be promising. The biggest advantage is, beside the high prefabrication rate, which take place in the factory under optimal conditions, the reduction of logistical costs. With this method it isn't necessary anymore to transport the formworks to the site and after the building process removing them again. They just stay at the factory the whole time where the prefabricated fibre-reinforced elements of the primary shell are produced. In this way, it is only necessary to transport the prefabricated elements to the place of construction, since these are used on site as permanent formwork, so that a removal becomes obsolete. Just the double-cross-connectors (DCC) need to be dismantled if they are not embed in the secondary shells concrete layer. The DCC, as newly developed connecting element, is very powerful. By the parametric adaptability of its dimensions, the relatively simple geometry, the reusability and adjustability to different curvatures the DCC can be used in a huge variety of free forms and load distributions.

However, this is only made possible by the workaround sequence and the parametric model itself. Otherwise it would take much more time to plan, calculate and fabricate the whole object. Besides the developed curvature based segmentation algorithm, on the basis of logistical dimension restrictions, slope of geometry and further formwork and concrete processing, the CAD-FEM-interface in both directions is the most important part.

5 CONCLUSION

In comparison to other building geometries, shell structures can be much more ecological and efficient. On one hand they require less resources for the remaining construction and on the other a highly efficient load transfer can be achieved. Also the shape is more natural and can offer new spatial qualities. But until now expensive, inefficient, time-consuming and often unique usable sub-structures and formworks are needed for those architectural typologies.

With this in mind a system was developed allowing to build freeform shells cheaper and more efficient than before. Based on the costs of our built prototype using the previous explained workaround and construction method and compared to other concrete freeform buildings with similar dimensions built in conventional procedures with lost unique formworks costs up to approximately 20% can be saved. One of the greatest factors need to be taken in account when it comes to cost minimization is that about the half of the shell, planed and build with the described method is made of prefabricated elements.

Moreover using fibre-reinforced thin concrete elements as main structural parts in the future will also decrease the costs and beside also the concrete cursed carbon dioxide emissions. Indispensable for this is an appropriate standardization of fibre-reinforced concrete.

Furthermore the process of planning and designing and the therefore integrated parametric software model has also a large impact on efficiency, material usage, shape and costs. The introduced developed digital workaround was summarized in a parametric model, explained schematically in Fig.4, and can be used as a tool to automate and reduce the workload for planning, analysing and generating fabrication data of freeform shells and even though it works in much cases it still has a lot of optimization potential. Besides this one of the biggest problems in the described workaround above is the fabrication of the double curved fibre reinforced concrete elements of the primary shell. In the moment the formworks are made by milling solid concrete blocks, which can be recycled after they aren't needed anymore. But a much more efficient way would be to use a flexible formwork system, which will be researched in extrapolation.

References

- Althaus, H.-J., Lehmann, M. (2011). Ökologische Baustoffliste (Version 2.2e). Dübendorf: For more Information see: <http://www.empa.ch/baustoffliste>
- Becker, N. (2013). Kurzanalyse Nr. 2: Ressourceneffizienz der Tragwerke. VDI Zentrum Ressourceneffizienz GmbH
- Becker, W., Horvath J. (2003). Entwicklung eines Betonierverfahrens zur Herstellung schräger und geneigter Flächen ohne Konterschaltung. Wien: In: Zement + Beton Handels- u. Werbeges.m.b.H.
- Block, P., Ochsendorf, J. (2007). Thrust Network Analysis: A new methodology for three-dimensional equilibrium. In: Journal of the international association for shell and spatial structures Bd. 48, S. 1–7
- Curbach, M., Jesse, F. (2009). Eigenschaften und Anwendung von Textilbeton. In: Beton- und Stahlbetonbau Bd. 104, Nr. 1, S. 9–16
- FIB – International Federation of Structural Concrete. (2008). Structural connections for precast concrete buildings. Lausanne: Bulletin, FIB
- Höbinger, M., Pottmann, H., Vouga, E., Wallner, J., Columbia Univ., Evolute, Kaust, TU Wien. (2012) Design of Self-supporting Surfaces
- Janssen, B., Walraven, J.C., Schipper, H. R., Vollers, K. J., Grünewald, S., TU Delft: Civil Engineering and Geosciences: Design and Construction, TU Delft, Delft University of Technology. (2011). Double curved precast load bearing concrete elements
- Jungjohann, H., Kürschner, K., Schober, H. (2004). Neue Messe Mailand – Netzstruktur und Tragverhalten einer Freiformfläche. In: Stahlbau 73, Heft 8, S. 541-551
- Kintscher, M. Verwendung von Verbindungselementen zur Verbindung von Betonfertigteilen.
- Kosche, F.-P. Schaltisch und Verfahren zur Herstellung von doppelt gekrümmten Bauteilen.
- KBA – Kraftfahrt-Bundesamt (2015). Jahresbericht 2013/2014. Flensburg: In. Flensburg, Germany, S. 29 & 36 For more Information see: http://www.kba.de/SharedDocs/Publikationen/DE/Jahresberichte/jahresbericht_2013_14_pdf.pdf
- Kristensen, M. K., Raun, C. A flexible mat for providing a dynamically reconfigurable double-curved moulding surface in a mould.
- Schätzke, C., Schneider, H. N., Joachim, T., Feldmann, M., Pak, D., Geißler, J., Hegger, J., Scholzen, A. (2011). Doppelt gekrümmte Schalen und Gitterschalen aus Textilbeton. Berlin: In. Berlin, Germany, S. 315–328
- Scheerer, S., Curbach, M. (2014). Leicht Bauen mit Beton. Dresden: TU Dresden Institut für Massivbau
- Schmidt, R., Wüchner, R., Bletzinger, K.-U. (2012). Isogeometric analysis of trimmed NURBS geometries. In: Computer Methods in Applied Mechanics and Engineering Bd. 241–244, S. 93–111
- Schober, H. Modulares Bauelement für die Erstellung doppelt gekrümmter oder freier Tragwerkformen.
- Thompson, D'A. W. (1945). On Growth and Form. Cambridge, New York Chap. XV., S. 934ff
- Turner, S. (2011). Klimakiller Beton. Auf: WeltN24 GmbH, Published 21.07.2011. For more information see: https://www.welt.de/print/die_welt/debatte/article13499011/Klimakiller-Beton.html
- VDZ – Verein Deutscher Zementwerke (2013). Energiebedingte CO₂-Emissionen der Zementindustrie in Deutschland in den Jahren von 1990 bis 2012 (in Millionen Tonnen) Auf: Statista. For more information see: <https://de.statista.com/statistik/daten/studie/239463/umfrage/energiebedingte-co-emissionen-in-der-zementindustrie/>
- Verhaegh, R. W. A. (2010). Free forms in concrete: the fabrication of free-form concrete segments using fabric formwork. Eindhoven: Technische Universiteit Eindhoven

Machine code functions in BIM for cost-effective high-quality buildings

Christoph Maurer¹, Wendelin Sprenger², Steffen Franz³, Jan Lodewijks², Uwe Rüppel³, Tilmann E. Kuhn¹

- 1 Fraunhofer Institute for Solar Energy Systems ISE, Heidenhofstr. 2, 79110 Freiburg, Germany, phone +49 761 4588-5667, fax +49 761 4588-9950, christoph.maurer@ise.fraunhofer.de
- 2 Ed. Züblin AG, Albstadtweg 3, 70567 Stuttgart, Germany, phone +49 711 7883-8692, fax +49 711 7883-179, wendelin.sprenger@zueblin.de
- 3 Institute of Numerical Methods and Informatics in Civil Engineering, TU Darmstadt, 64287 Darmstadt, Germany, phone +49 6151 16 21336, fax +49 6151 16 21339, franz@iib.tu-darmstadt.de

Abstract

Building Information Modeling (BIM) is one way of making the complex building processes less expensive and more reliable. This paper first analyses existing experience with building processes which include building-integrated solar systems as one example of buildings with high ecologic ambitions. Based on the analysis, it is proposed to include functions in machine code into the next version of the Industry Foundation Classes (IFC). For the machine code functions, several formats are proposed and the advantages and disadvantages of the proposed IFC extensions are discussed. As several formats have specific advantages and disadvantages, it is recommended to offer them as an option. For simple conventional buildings, the existing IFC version 4 seems appropriate. Buildings which include innovations which add complexity to the building process can profit most by the savings generated by exchanging machine code functions. The cost-effectiveness can be increased because more knowledge can be shared due to the confidentiality of the machine code, less time is needed for variations of the models, the higher accuracy of detailed models can be used, more competition is possible due to the modularity of the functions and less mistakes while exporting and importing models are made using the same validated model.

Keywords

simulation, building information modelling (BIM), building-integrated solar systems (BISS), building-integrated solar thermal systems (BIST), solar building envelope, building process, industry foundation classes (IFC)

1 INTRODUCTION

Scenarios for the energy transition such as (Henning & Palzer, 2014; Palzer & Henning, 2014) typically include a reduction of the energy demand of buildings as well as renewable energy sources. The European parliament and council has decided that from 2020 on all new buildings have to be nearly zero-energy buildings (NZEB) (European Parliament & European Council, 2010). The energetic requirements for new and refurbished buildings are increasing for example in Germany with (EnEV, 2001, 2004, 2007, 2009, 2013). At the same time more and more "green buildings" fulfil the high requirements of certificates of LEED (U.S. Green Building Council), BREEM (Building Research Establishment) and DGNB (Deutsche Gesellschaft für Nachhaltiges Bauen). Recent publications like (Maurer, Cappel, & Kuhn, submitted) present that building-integrated solar systems can reduce the costs compared to refurbishing the building envelope first and adding solar systems afterwards. It is therefore likely that solar building envelopes will become more and more important for the construction industry, especially regarding high-quality buildings which aim at a zero energy balance or even a plus energy balance. With the additional function as a supply of solar energy, solar building envelopes are more complex than conventional building envelopes. The current paper is based on (Maurer, Sprenger et al., submitted) and analyses first the existing building process and the experiences of demonstration buildings including solar envelopes and proposes how they can be handled in a cost-effective way. The building process extends in this case from the planning over the construction up to the facility management. Finally, the advantages and disadvantages of the propositions are discussed and concluded.

2 METHOD AND RESEARCH

Many building processes to date involve several stakeholders which receive their necessary input as text e.g. in an email or a 2D report. Then they use their own methods and tools and share their results e.g. as another 2D report. This often works but a lot of information is lost and some information has to be generated by more than one stakeholder and is not shared with other stakeholders who could save costs by using it. It is also a risk for the quality of the building process if only parts of the generated information is shared because different stakeholders may assume different values in the not shared parts. Errors can also occur during exporting information into a 2D report and importing it from such a report. One reason for this may be the effort of sharing more information, the confidentiality of some business secrets and the fear of being responsible for all shared information. As the exchange of information can make the whole building process more cost-effective and reliable, there have been efforts by several companies within buildingSMART (buildingSMART, 2016) to establish the Industry Foundation Classes (IFC) as the open format for exchanging information during the building process. For example the exchange of a 3D geometric model including semantic information can save a lot effort. The building process is also addressed by buildingSMART (;). However, the IFC schema separates building elements and distribution elements. Merged components like solar building envelopes have not yet been included into the IFC and the processes. Therefore two examples of the integration of an innovative transparent solar thermal collector into two buildings will be analysed.

During the development of the transparent solar thermal collector (TSTC) within the project (Kuhn, 2008-2012), it became clear that the energetic properties of a solar thermal façade like the g value (or solar heat gain coefficient or solar factor) depend on the operation of the façade collectors (Maurer & Kuhn, 2012). At the same time, the efficiency of the façade collectors depends on the building services which use the renewable heat. At low temperatures this efficiency is considerably higher than at high temperatures. To evaluate the new collector concept, a simulation model of the collector

was developed (Maurer, 2012) and as high-rise buildings were targeted, an averaged floor plan was developed which included offices facing each cardinal direction as well as corridor, meeting room, copier room, kitchen and core areas. The same façade element including window with internal venetian blinds, an opaque part at the floor slab and the transparent collectors at the spandrel area was used for all offices. The HVAC system included thermally activated building systems, a sorption chiller and a compression chiller, a gas boiler, buffer storages and hybrid coolers. Different volumes of the heat storage were investigated as well as using the building mass as additional storage.

Although it is just a case study, this evaluation is complex and hardly feasible by one stakeholder. A large façade company was contributing their know-how about façade elements and high-rise floor plans, an experienced HVAC planner designed the building services and a research institute modelled the transparent collector. The results were published in (Maurer et al., 2013). The researchers were not experienced with building services and the HVAC planner not with the detailed physical model of the façade collector. Therefore the complexity of the collector modelled was encapsulated in a new Type in TRNSYS (Beckman et al., 1994) which is easy to use and the building services were modelled in TRNSYS and MATLAB (MathWorks). To exchange a TRNSYS TypeX, a Dynamic Link Library DLL file is exchanged which contains the function TypeX() in machine code and which is used by the TRNSYS solver and a proforma file which is used only for the TRNSYS graphical user interface. In addition, an example deck of the collector model, the building and the building services can be provided to make the start easier. Based on the simulations, a real high-rise building project could be realized.

Apart from this case study, a demonstration installation of the transparent façade collectors was planned (Maurer et al., 2012), built and monitored (Maurer et al., 2014). The building process is analysed here according to the process map of (5D-initiative). During the project development, suitable locations for the solar active area of the building envelope need to be identified first for which at least the architect or building owner and someone with experience in solar energy was involved. In some cases it is obvious that the upper part of the south façade is suited best. In other cases, simple whole-year simulations can compare e.g. a west façade to a partially shaded south façade. An estimation of the energy demands of the building is essential to evaluate different building systems which use the solar thermal energy. The solar (building) envelope should also fit well aesthetically into the design of the refurbished building.

During the technical design, a simulation model of this solar thermal building envelope was developed by the research institute. This simulation model can be used for other applications of these collectors or could be modified quickly for similar collector variants. With the simulation model, the HVAC planner compared the maximum heating and cooling supply of the building services with the necessary heating and cooling demand. It is essential that the characteristics of the components which are assumed for this maximum heating and cooling supply and the functional description of the building services are fulfilled by the components which are later installed by another company. In parallel, the building site was inspected at least by the façade manufacturer in order to plan the refurbished building envelope in detail including the installation of the solar thermal façade. In this case of a demonstration building, an extensive monitoring system is recommended. In a commercial application without scientific evaluation, few sensors should be included to allow the facility manager later to check the performance of the building-integrated solar thermal (BIST) system. If the system is changed at a late stage of the technical design, the preceding results should be updated. In this case an additional flat-plate collector field was installed as a back-up without changing the design of the building services which resulted in a not optimized performance.

During the work planning, a timeline of the refurbishment was developed according to which the building was refurbished in the construction phase. During the facility management, the values of the sensors should be checked for plausibility as soon as the system is operating. In this case of a

scientific monitoring, the monitoring values of several months should be analysed. In the case of a commercial installation, the system performance should be checked after one year of operation because then data is available for different seasons and operating conditions. If the system is not operating as expected, optimizations e.g. of the control should be implemented.

Some of the necessary tasks can be performed by one stakeholder. For example can a solar consultant analyse defined areas of the building envelope with his tools and recommend the best suited area to the architect. For other tasks it seems beneficial if know-how of one stakeholder is transferred to another stakeholder. For example is the HVAC planner enabled to perform simulations of the building, the solar envelope and the building services by receiving an easy to use model of the solar envelope created by a research institute. The research institute or test lab could also measure and model BIST elements for a manufacturer of solar envelopes who could then offer the simulation tool together with his BIST elements. However, the BIST manufacturer probably does not want his competitors know the physical details of his solar envelope. A model which is shared in machine code can hide the details. Therefore it could be shared easily. A model could also be shared by describing all inputs, outputs and equations in a text file. This would disclose details of the component to competitors and it would be much more difficult to convert the model in text format and from text format into an executable simulation model than sharing the model in machine code e.g. by sending a DLL file. Without a validated simulation model, innovative building-integrated solar systems (BISS) are difficult to sell because important advantages cannot be quantified. In addition, the innovative components can hardly contribute with their advantages to the energy transition without a building process that can handle solar envelopes.

This analysis was done for building-integrated solar thermal systems, but the results are applicable also for other solar envelopes such as building-integrated photovoltaics (BIPV), building-integrated photovoltaic-thermal (BIPVT) systems and passive building envelopes including daylighting and solar control.

3 RESULTS

An open format to exchange information during the building process like the Industry Foundation Classes (IFC) is important because stakeholders of a building process may use software from different manufacturers and still need to exchange their information. If one software manufacturer would dominate the market with a closed format, the software prices could rise. The current version of the IFC is version 4. The aim for the future is that all necessary input for more than one stakeholder can be exchanged in the IFC and that the stakeholder can return his output in the IFC format.

If for example a sub-component of a BIST façade is to be specified with high accuracy – e.g. one individual glass pane for the BIST façade of a high-rise building – then the values for several angles, two polarizations and hundreds of different wavelengths should be exchanged between the glass manufacturer or the laboratory measuring this glass pane and the stakeholder who creates the simulation model of the BIST element. This is can be costly and error prone since there is actually no generally accepted format for such data for automated export and import of this information. Additional difficulties for the specification of such a format is that different formats are used by different software programs and that the requirements for the format depend on the component itself. As an example it can be mentioned that the spatial resolution needs to be very high at least in some solid angles for façade elements with strongly angle dependent properties and that the format has to be capable of variable spatial resolutions. However, even if there is a high

flexibility and complexity in the specification of the properties of complex façade elements, it is still possible that new innovative components are out of scope of the format and that they cannot be specified reliably with the given format. An alternative is to exchange functions in machine code for the description of the properties of the façade elements. If functions in machine code are allowed in future IFC versions, it can be assured that innovative components can always be described.

If we assume that functions in machine code are exchanged and that a solar thermal façade has been built in this way, then the analysis of the next BIST building process can illustrate the capabilities of this approach. Fig. 2 presents a schematic drawing of five functions in machine code. Assuming that only the glass pane facing the exterior is changed in the BIST element, the function of the old glass pane can be easily exchanged by the new function and the optical properties of the entire BIST element as well as the energetic simulation model of the BIST element can be generated at once, because the optical properties of the other subcomponents and their thermal properties remain the same. Function 4 needs the definition of the building and the building services which could be imported from IFC. Then it can provide the energy demand and comfort in the building. Function 5 needs as input except of Function 4 for example data about the internal loads and the weather to calculate performance indicators to assist the facility manager. Function 5 uses function 4 which uses function 3 and so on.

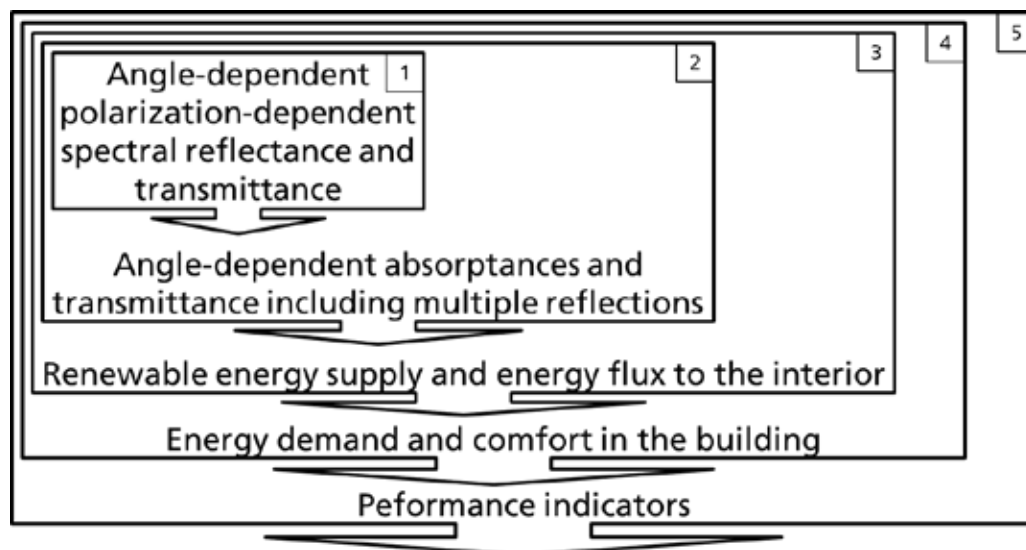

FIG. 1 Schematic drawing of five functions in machine code. Function 1 provides the optical properties of the new glass pane. Function 2 provides the optical properties of the whole BIST element. Function 3 is the energetic simulation model of the BIST element. Function 4 is the energetic simulation model of the building including the BIST element and the building services. Function 5 is a tool for the facility management which indicates if the BIST system performs as expected.

Typically, different models are used on different levels of detail by different stakeholders while the same model could be used. Much information and sometimes important characteristics are lost by using a much simpler model at the next higher level of detail. For example, a high-performance building envelope may be modelled in detail but for the building simulation a much simpler model may be used and the building services may be designed with an even simpler model of the building. However, adaptive functions in machine code can be built which can switch between different levels of detail and the functions need to call their sub-functions only once if their results are not time-dependent. In many cases, the calculating times are the limiting factor. Nevertheless, functions in machine code can have short calculating times as long as they are programmed well.

On the one hand side, this process is cost-effective because little time is needed to adapt the machine code functions to a new building process. On the other side, it offers a large flexibility which can also save costs. Not one expert needs to build the BIST simulation model with one code, but different stakeholders can contribute with what they can contribute best and the results can be used by the other stakeholders to create machine code functions for numerous tasks.

If machine code functions shall be exchanged, there are various formats how they can be exchanged. They could be within an executable with an input and an output file, but in this case, nested functions would have long computing times because of the reading and writing process. The machine code functions can also be part of a dynamic link library (DLL) or shared object (.so). In that way, nested functions may require more random access memory (RAM) but could offer short computing times. It is essential that a description of the name of the function and its arguments and their formats is shared together with the machine code function. It is also recommended to explain the function and the arguments in text in order to avoid wrong usage of the function. The function may be used in various simulation environments and in combination with several programming languages. It could therefore be agreed not to share the minimum requirement of the function and the description, but an example of how to use it in a specific programming language or simulation environment in order to make it easier to use the functions. The exchange of a TRNSYS Type as mentioned above with a DLL, a proforma file and an example deck is one example of exchanging machine code functions which are easy to use in a single simulation environment. For this approach it is recommended to use a single source code with options to generate machine code for different environments turning an existing simulation model into a multi-environment simulation model. Another approach is the standardization of exchanged machine code function and the description as proposed by (fmi-standard.org, 2014) as Functional Mock-up Units (FMU) with Functional Mock-up Interface (FMI). The standardization allows various programs to read the description and use the function automatically. The description of the function can include all the details of the function like all equations. However, this should not be mandatory in order to allow confidentiality of business secrets within the function.

For each building process, one way of data exchanged would be desirable and therefore there are countless desirable ways of exchanging information for different building processes. Therefore, the version of the Industry Foundation Classes should ideally allow all proposed ways of exchange.

4 DISCUSSION

The last section proposed in general to include machine code functions in the data exchange of building processes. If it is done right, it could make high-quality buildings more cost-effective because

- more knowledge is shared due to the confidentiality of the machine code
- less time is needed for variations since no export to text and import from text format is needed
- the higher accuracy of detailed models can be used instead of simplifying models
- more competition due to the modularity of the functions
- less mistakes during exporting and importing models by using the same validated model

In general, the transition from building processes without exchange of machine code functions needs the effort of adaptation. If the exchange of machine code functions is done with bad quality, a lot of effort can be needed to use functions of other stakeholders, large computing times may result and the functions may generate wrong results. However, these disadvantages can already appear in the state of the art of high-quality buildings where the building processes need to adapt to the innovative components, where a lot of effort may be needed to include these components, where large computing times may result and mistakes may cause wrong results.

The result section then proposed several ways of exchanging machine code functions. In general, the next IFC version should offer many ways of exchanging code and machine code because of reasons mentioned above and because it exchange of information apart from IFC is difficult to include into the building process. Such an extension would not affect conventional building processes because it can be ignored, but can make the building process of high-quality buildings more cost-effective when it is executed well.

The minimum exchange of machine code involves the function and a description of the name and the arguments of the function. It has the advantage that it is easy to build and to document and the drawback that some effort can be necessary to use the function. Adding an exemplary uses of the function needs little effort if it is only for one simulation environment or programming language and helps using the function a lot. Examples for many simulation environments and programming languages first need the effort of coupling a function to this environment or language. After that it is rather easy to provide many examples.

Sharing functions as an executable may be helpful for certain cases where the inputs and the outputs shall be checked and modified by a human being. However, they cannot be recommended to be used within nested function if the computing times are crucial. Sharing machine code functions as shared object (.so) or DLL has the drawback that nested functions may need much RAM. Using adaptive simulation models with variable accuracy and smart usage of the functions, the shared object/DLL approach offers fast computing times even for nested functions when the RAM is not the limiting factor.

Documentation with a lot of explanation about the variables used by the function and how the function works can need a substantial effort but reduces the risk of wrong usage of the function. It is therefore recommended in cases where the arguments of the function are not obvious but complex to be understood and used right.

A standardized way of providing the minimum exchange of machine code can make the implementation in several simulation environments much easier. It needs to offer the option of confidentiality and it would be much cheaper than generating implementations for many simulation environments. Just one implementation of the standardized interface would be needed in each simulation environment. However, some innovative components are difficult to couple with the existing models especially if parts of the source code of the simulation environment are closed. Therefore the option of sharing implementations of one function for specific environments is necessary. The effort for an implementation in a new environment or version of the same environment may be substantial, but as long as an implementation of a function works well, it is easy to provide implementations of similar functions.

It is also possible to share the entire source code when no business secrets interfere. In some cases it is very easy to include a certain source code in a certain simulation environment. In other cases, compiling the source code and linking it to rest of the simulation may need similar effort compared to receiving a machine code function and implementing this function.

The confidentiality of a machine code function depends on the effort needed to decompile the function and disclose the business secrets. The detailed physical model of (Maurer, 2012) uses about 1400 variables. Without knowing the names of the variables and the nested functions, it will be hard to disclose the physical details of the transparent solar thermal collector by decompiling the DLL. Simple BIST models as presented in (Maurer, Cappel, & Kuhn, 2015) can be built with a few lines of code but they include typically empirical parameters which do not provide much information about the technical details of the component. In any case, manual and automated obfuscation can be used so that the effort of reverse engineering increases substantially. If even this level should not be enough due to the importance of the business secret, it is recommended to develop a simpler model from which the technical details cannot be extracted even if the full source code were available.

5 CONCLUSIONS

This paper first analysed existing experience with building processes including a new building-integrated solar thermal façade element. Based on the analysis, it is proposed to include machine code functions into the next version of the Industry Foundation Classes in different formats. The advantages and disadvantages of the proposed additions were discussed. As several formats have specific advantages and disadvantages, the next IFC version should not exclude some of them but offer them as an option. The paper has been focusing on building-integrated solar systems which are more complex than conventional building envelopes. However, machine code functions offer a way to make their building process more cost-effective and reliable and the exchange of machine code functions may contribute also to other high-quality buildings using innovative components for example with adaptable building envelopes without active solar systems. For simple conventional buildings, machine code functions may not be needed.

Acknowledgements

This work was funded by the German Federal Ministry for Economic Affairs and Energy, based on a decision by the German Bundestag.

References

- 5D-initiative. Process map.
- Beckman, W. A., Broman, L., Fiksel, A., Klein, S. A., Lindberg, E., Schuler, M., & Thornton, J. (1994). TRNSYS The most complete solar energy system modelling and simulation software. *Renewable Energy*, 5(1-4), 486–488. doi:10.1016/0960-1481(94)90420-0
- Building Research Establishment. Building Research Establishment Environmental Assessment Method (BREEAM). Retrieved from <http://www.breeam.com/>
- buildingSMART. (2016). Homepage of the international non-profit organization buildingSMART. Retrieved from <http://buildingsmart.org/>
- Deutsche Gesellschaft für Nachhaltiges Bauen. German Sustainable Building Council (DGNB) certificates. Retrieved from <http://www.dgnb.de/dgnb-ev/en/>
- EnEV. (2001). Verordnung über energiesparenden Wärmeschutz und energiesparende Anlagentechnik bei Gebäuden (Energieeinsparverordnung - EnEV): Bundesgesetzblatt Teil 1; Nr. 59, Seiten 3029 - 3104.
- EnEV. (2004). Bekanntmachung der Neufassung der Energieeinsparverordnung: Bundesgesetzblatt Teil 1; Nr. 64, Seiten 3146 - 3162.
- EnEV. (2007). Verordnung über energiesparenden Wärmeschutz und energiesparende Anlagentechnik bei Gebäuden (Energieeinsparverordnung - EnEV): Bundesgesetzblatt Teil 1; Nr. 34, Seiten 1519 - 1563.
- EnEV. (2009). Verordnung zur Änderung der Energieeinsparverordnung: Bundesgesetzblatt Teil 1; Nr. 23, Seiten 954 - 989.
- EnEV. (2013). Zweite Verordnung zur Änderung der Energieeinsparverordnung: Bundesgesetzblatt Teil 1; Nr. 67, Seiten 3951 - 3990.
- European Parliament, & European Council. (2010). Directive 2010/31/EU of the European Parliament and of the Council of 19 May 2010 on the energy performance of buildings (recast). *Official Journal of the European Union*, 53(L153), 13–35.
- fmi-standard.org. (2014). Functional mock-up interface for model exchange and co-simulation. Retrieved from [fmi-standard.org](http://www.fmi-standard.org) website: <https://www.fmi-standard.org/>
- Henning, H.-M., & Palzer, A. (2014). A comprehensive model for the German electricity and heat sector in a future energy system with a dominant contribution from renewable energy technologies – part I: methodology. *Renewable and Sustainable Energy Reviews*, 30, 1003–1018. doi:10.1016/j.rser.2013.09.012
- International Organization for Standardization.
- International Organization for Standardization.
- International Organization for Standardization.
- Kuhn, T. E. (2008-2012). Cost-Effective: Converting façade of existing high-rise buildings into multifunctional, energy gaining components. Homepage. Retrieved from <http://www.cost-effective-renewables.eu/>
- MathWorks. MATLAB (MATrix LABoratory) numerical computing environment. Retrieved from <http://www.mathworks.com/products/matlab/>
- Maurer, C., Baumann, T., Hermann, M., Di Lauro, P., Pavan, S., Michel, L., & Kuhn, T. E. (2013). Heating and cooling in high-rise buildings using facade-integrated transparent solar thermal collector systems. *Journal of Building Performance Simulation*, 1–9. doi:10.1080/19401493.2013.766263
- Maurer, C., Gasnier, D., Pflug, T., Plešec, P., Hafner, J., Jordan, S., & Kuhn, T. E. (2014). First Measurement Results of a Pilot Building with Transparent Façade Collectors. *Energy Procedia*, 48, 1385–1392. doi:10.1016/j.egypro.2014.02.156
- Maurer, C., & Kuhn, T. E. (2012). Variable g value of transparent façade collectors. *Energy and Buildings*, 51, 177–184. doi:10.1016/j.enbuild.2012.05.011
- Maurer, C., Pflug, T., Di Lauro, P., Hafner, J., Knez, F., Jordan, S., . . . Kuhn, T. (2012). Solar heating and cooling with transparent façade collectors in a demonstration building. *Energy Procedia*, 30, 1035–1041. doi:10.1016/j.egypro.2012.11.116
- Maurer, C. (2012). Theoretical and experimental analysis and optimization of semi-transparent solar thermal façade collectors (Dissertation). Karlsruhe Institut für Technologie (KIT), Freiburg. Retrieved from <http://publica.fraunhofer.de/documents/N-203747.html>
- Maurer, C., Cappel, C., & Kuhn, T. E. (submitted). Progress in building-integrated solar thermal systems. *Solar Energy*.
- Maurer, C., Cappel, C., & Kuhn, T. E. (2015). Simple models for building-integrated solar thermal systems. *Energy and Buildings*, 103, 118–123. doi:10.1016/j.enbuild.2015.05.047
- Maurer, C., Sprenger, W., Franz, S., Lodewijks, J., Rüppel, U., & Kuhn, T. E. (submitted). Machine code functions in BIM for cost-effective high-quality buildings. *Energy and Buildings*.
- Palzer, A., & Henning, H. M. (2014). A comprehensive model for the German electricity and heat sector in a future energy system with a dominant contribution from renewable energy technologies – Part II: Results. *Renewable and Sustainable Energy Reviews*, 30, 1019–1034. doi:10.1016/j.rser.2013.11.032
- U.S. Green Building Council. Leadership in Energy and Environmental Design (LEED). Retrieved from <http://www.usgbc.org/leed>

Thermal and Energy Performance of Double Skin Facades in Different Climate Types

Ajla Aksamija¹

¹ Department of Architecture, University of Massachusetts Amherst, Fine Arts Center 363, Presidents Drive 151, Amherst, MA 01003, USA, +1 413 545 7150, aaksamija@umass.edu

Abstract

This paper explores thermal and energy performance of double skin facades (DSFs) in different climate types, specifically focusing on three typologies: box window, corridor type and multistory DSFs. These systems were investigated and analyzed to answer the question of how the different DSFs perform in comparison to each other, as well as a typical curtain wall (single skin facade used as a baseline), in a multitude of climate applications. The utilized research methods included two-dimensional heat transfer analysis (finite element analysis), Computational Fluid Dynamics (CFD) analysis and energy modeling. Heat transfer analysis was used to determine heat transfer coefficients (U-values) of all analyzed facade types, as well as temperature gradients through the facades for four exterior environmental conditions (exterior temperatures of 32°C, 16°C, -1°C and -18°C). Results indicate that there is little variation in thermal performance of the different DSF types, but that all DSF facades would have significantly improved thermal performance compared to the baseline single skin facade. Then, CFD analysis investigated three dimensional heat flow, airflow and air velocity within air cavity of DSFs. Results indicate that the differences between the three types of DSFs influence airflow in the air cavity. Lastly, energy modeling was conducted for south-oriented office space, which would be enclosed by the analyzed facade types. Individual energy models were developed for each facade type and for 15 different climates, representing various climate zones and subzones. The results were analyzed to compare energy performance of DSFs and baseline single skin facade, as well performance of DSFs in various climate types. The results indicate significant differences between the DSFs and single skin facade, but less variations between the different typologies of investigated DSFs. Moreover, the results show what would be the effect of DSFs in different climate types on energy performance, heating and cooling loads.

Keywords

Double skin, energy efficiency, finite element analysis (FEA), computational fluid dynamics (CFD), thermal performance, energy consumption, climate types

1 INTRODUCTION

Double skin facades (DSFs) consist of three distinct layers – interior glazed wall system, ventilated air cavity, and exterior glazed wall system. The ventilated air cavity serves as a thermal buffer between the interior and exterior glazed walls. Basic DSF types are box window, corridor facades, shaft box facades, and multistory facades (Aksamija, 2013). The physical behavior of the DSFs depend on the typology, as well as ventilation mode of the air cavity and material components. Ventilation mode can include natural ventilation, mechanical and mixed mode.

DSFs have been primarily used in cold and temperate climates, although there are some examples in warmer climates. There is significant research available relating to the thermal and energy performance of DSFs in temperate and colder climates, while less research is available for warmer climates. A previous literature review study was conducted, which systematically reviewed and compared research articles focusing on energy performance analysis of DSFs in temperate climates (Pomponi et al., 2016). Gratia and Herde looked extensively at DSFs in a temperate climate, analyzing behavior for various sun orientations, and how applying the DSF affected heating and cooling loads (2007). Energy performance and analysis, specifically for heating, cooling and ventilation energy usage, was also included in a study comparing DSF to other facade alternatives for a specific building application in central Europe (Gelesz & Reith, 2015). For hot climate areas, summer ventilation for DSF leads to increased cooling loads (Eicker et al., 2007). Through CFD simulation and comparative analysis, horizontal and vertical ventilation schemes were evaluated for double skin facade in Mediterranean climate (Guardo et al., 2011). Brandl et al. studied the airflow characteristics and temperature profile of multifunctional facade elements through comprehensive analysis and comparison by using CFD models, and the results identified that the ventilation effects of side openings can help decrease cavity temperature (2014). However, studies that systematically investigate thermal and energy performance of DSFs facades in all types of climates currently do not exist. Moreover, studies that also investigate different typologies of DSFs and their thermal and energy performance are currently very limited. Since there is lack of research that systematically compares thermal and energy performance of different types of DSFs in all climate types, this research study focused on addressing this gap in knowledge.

2 METHODOLOGY

The objectives of this research were to investigate thermal performance of different types of DSFs, and to investigate effects on energy performance in all climate types. Research questions that were addressed include:

- What is the thermal performance of different types of DSFs, specifically in terms of heat transfer coefficients (U-values)?
- How does the outside temperature affect the oscillation of temperatures in the air cavity between internal and external glazing in different types of DSFs?
- What is the effect of outside temperature and solar radiation on airflow patterns and air velocity in the air cavity for different types of DSFs?
- What is the effect of different types of DSFs on energy consumption for commercial office spaces in all climate types?
- How do DSFs influence the heating and cooling loads in different types of climates? What are the energy saving potentials for different DSFs?

Different modeling and simulation tools were used in the study to evaluate heat transfer, airflow, and the energy saving potentials for box window, corridor type and multistory DSFs. The results were compared against the baseline model, consisting of a standard curtain wall (single skin facade). In all DSF scenarios, curtain wall with double insulated glazing unit was placed on the interior side of the facade, while single lite of glass was placed on the exterior side. The first step of the study consisted of 2D finite element heat transfer analysis to determine U-values, followed by CFD analysis and energy modeling.

2.1 HEAT TRANSFER ANALYSIS

The heat transfer analysis utilized a 2D finite element analysis method, using THERM 6.3 and WINDOW 6.3 modeling software programs. THERM was developed by Lawrence Berkeley National Laboratory (LBNL), and it is widely used for thermal analysis of facade systems. WINDOW was also developed by LBNL, and it is interoperable with THERM. THERM calculates conductive heat transfer, considering interior and exterior environmental conditions, and the conductive properties of air and materials in the facade assembly. The different analyzed facades (typical curtain wall, as well as different types of DSF) were initially drafted as 2D sections and plans in CAD, and then imported as an underlay in THERM to develop thermal analysis models. THERM relies on detailed 2D representations of all components and materials, placement of appropriate materials and definitions of material properties, as well development of boundary conditions that represent exterior and interior environmental conditions.

All DSF facade systems used two glazed layers, with an air cavity between them. The interior layer consisted of 25 mm double low-e insulated glazing unit (IGU) with argon gas fill, and the exterior layer consisted of 13 mm single tempered glazing. The reason for selecting argon gas filled IGU for DSFs is that if a double skin is used to improve facade performance on a specific building project, designers typically want to maximize performance improvements and energy savings. Base case scenario was a standard curtain wall, with 25 mm double air low-e IGU. The glazing units and their properties were calculated in WINDOW and imported into THERM. The framing members for the typical curtain wall and the interior layer of the DSF included aluminum mullions. The outer layer of the DSFs did not include aluminum framing members—the assumption was that structural silicone would be used for glazing. For the box window DSF, the assumption was that the horizontal and vertical division panels between floors and individual windows would be constructed out of aluminum. For the corridor type DSF, the assumption was that the horizontal division panels between floors would also be constructed out of aluminum.

Each facade type was simulated for four different exterior temperatures (32°C, 16°C, -1°C and -18°C) in order to represent various climatic conditions, where both sections and plans were simulated for all facade types. The interior temperature was held constant at 20°C. Results were represented as thermal gradients, indicating temperature differentials within the cavity. U-values were also calculated, where the simulation inputs for environmental conditions were determined based on the NFRC 100-2004 Standard, considering exterior temperature of -18°C and interior temperature of 21°C (NFRC, 2004). Therefore, twenty different models were developed, where results for sixteen models were used to determine thermal gradients for various exterior environmental conditions, and four models were used to calculate U-values.

2.2 COMPUTATIONAL FLUID DYNAMICS (CFD) ANALYSIS

Computational Fluid Dynamics (CFD) analysis implements numerical simulation methods to seek solutions to fluid flow problems. For this study, Ansys Fluent 17.1 CFD simulation program was used, where models for the investigated DSF types were developed using the same dimensions, components and materials properties as THERM heat transfer analysis. Different scenarios were developed to simulate how box window, corridor type and multistory DSFs perform under various environmental conditions. For each facade type, different models were developed to represent exterior temperatures of 32°C, 16°C, -1°C and -18°C, while the interior temperature was constant at 20°C. The geometries were built as 3D models in Rhino modeling software, and imported to Fluent. Boundary conditions for each identified facade component were set according to different temperature scenarios. DSFs' vertical sides were identified as adiabatic and the velocity input for air inlet depended on wind speed in different seasons. Sixteen different models were developed, representing four facade types and four exterior environmental conditions.

2.3 ENERGY MODELING

Energy modeling was performed by EnergyPlus 8.4.0, where the models were created in SketchUp 2016 and OpenStudio 1.10.0. This method utilized OpenStudio as the model builder, and EnergyPlus as the energy analysis engine. The methodology for energy modeling consisted of building individual models for each type of investigated facade, which would enclose a commercial office space. The models did not represent whole building, but rather a single south-facing zone. The models were created for fifteen different climate types, representing all climate zones in the U.S., where TMY3 weather data files were used for the simulations. Table 1 shows representative cities that were chosen for energy modeling. The dimensions and material properties of the facades were identical to previously discussed characteristics. The baseline model was a standard curtain wall, and all other models were enclosed by the different types of DSF. The energy models represented a single zone per floor, totaling 12 m² per floor (3 m wide and 4 m deep office space). Also, models were developed for a two-story and four-story application in order to investigate the effects of height on the performance of multistory DSF. All investigated DSFs considered only natural ventilation within the air cavity. Therefore, 120 different energy models were developed and simulated.

The inputs for occupancy loads, system loads, equipment loads, lighting and ventilation were based on ASHRAE 90.1 energy code and recommendations prescribed by the ASHRAE 189 standard (ASHRAE, 2014; ASHRAE 2013). The material properties and optical properties of glazing were identical to heat transfer analysis. Operating schedule was based on a typical office space operation (weekday schedule from 8 AM to 6 PM). The HVAC system consisted of a packaged heating/cooling pump with DX coils, and natural gas used for heating. The results were calculated for all models, where total annual energy consumption was determined for each individual scenario, as well as the heating, cooling and lighting loads. Also, Energy Usage Intensity (EUI) was calculated for all scenarios.

CLIMATE ZONE	CITY	STATE	ZONE	REGION
1A	Miami	Florida	Very hot	Moist
2A	Houston	Texas	Hot	Moist
2B	Phoenix	Arizona	Hot	Dry
3A	Memphis	Tennessee	Warm	Moist
3B	El Paso	Texas	Warm	Dry
3C	San Francisco	California	Warm	Marine
4A	Baltimore	Maryland	Mixed	Moist
4B	Albuquerque	New Mexico	Mixed	Dry
4C	Salem	Oregon	Mixed	Marine
5A	Chicago	Illinois	Cool	Moist
5B	Boise	Idaho	Cool	Dry
6A	Burlington	Vermont	Cold	Moist
6B	Helena	Montana	Cold	Dry
7	Duluth	Minnesota	Very cold	-
8	Fairbanks	Alaska	Subarctic	-

TABLE 1 Climate zones and representative cities that were incorporated into energy modeling

3 RESULTS

3.1 HEAT TRANSFER ANALYSIS

The results of the 2D heat transfer analysis consisted of two sets of data—the first set of data indicated thermal gradients through investigated facade systems for four exterior environmental conditions, as seen in Fig. 1 for exterior temperature of -18°C , and the second set of data demonstrated U-values.

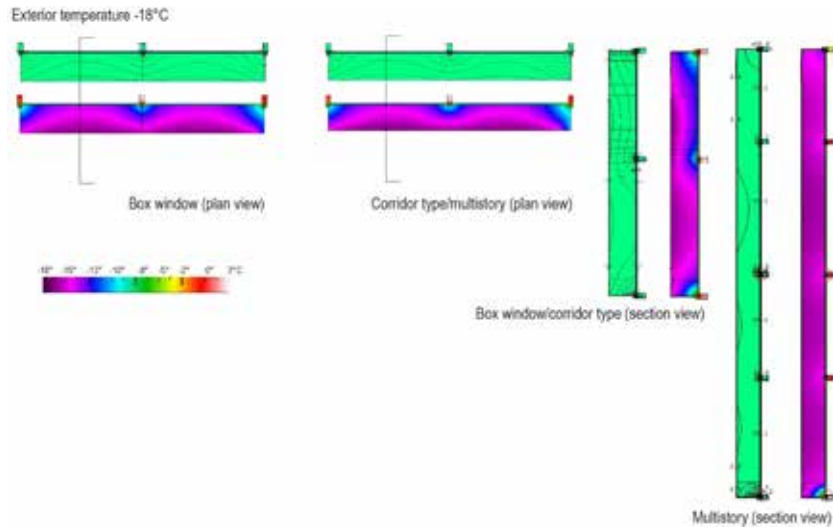

FIG. 1 Results of heat transfer analysis, showing thermal gradients in DSFs (exterior temperature of -18°C)

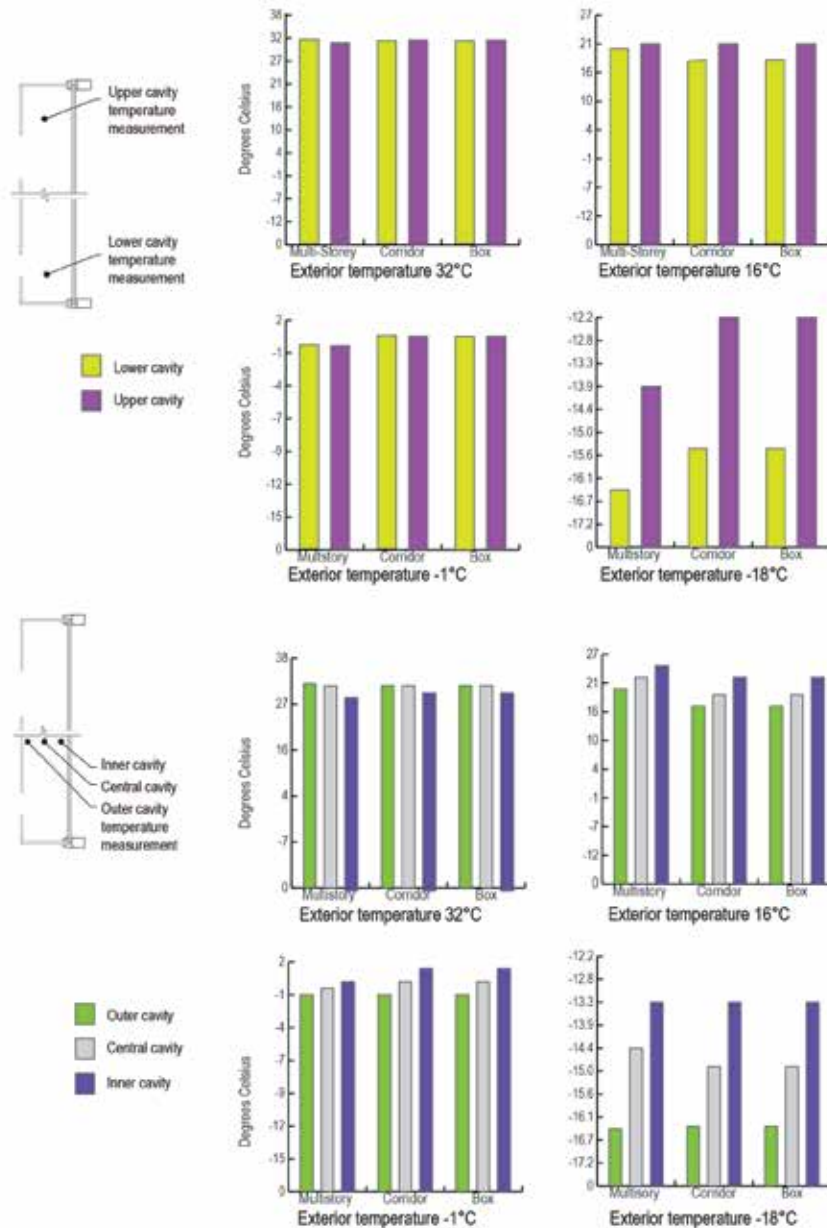

FIG. 2 Results of heat transfer analysis, showing temperatures in air cavity for investigated DSPs

Fig. 2 indicates temperatures within upper and lower parts of cavities for all three DSF types (and for all four exterior environmental conditions), as well as the inner and central parts. Results indicate that for exterior temperatures of -1°C and -18°C, there is a larger difference in temperature within lower and upper parts of the air cavity. As the exterior temperature increases (such as 16°C and 32°C), there is less differentiation between the lower and upper parts of the air cavity. Another observation is that there is slight variation in results based on the DSF typology. For example, multistorey DSF shows smaller discrepancies than corridor type or box window DSF.

	SINGLE SKIN (CURTAIN WALL)	BOX WINDOW DSF	CORRIDOR TYPE DSF	MULTISTORY DSF
U-value (W/m ² -K)	1.022	0.182	0.204	0.176

TABLE 2 Calculated U-values for the investigated facade types

Heat transfer coefficients (U-values) were calculated for conventional curtain wall, as well as three investigated DSF types. Table 2 shows the results, indicating the relative thermal performance of each investigated facade type. All DSF types have much lower U-value than a standard curtain wall, indicating that these facade types would have improved thermal performance. The differences between different DSF typologies are relatively small; however, multistory DSF would have the smallest U-value, followed by box window and corridor type DSF. Nevertheless, the significant difference between U-values of DSF types and conventional curtain wall suggests that all types of DSFs would provide savings in heating and cooling loads due to improved thermal performance.

3.2 CFD ANALYSIS RESULTS

The results of CFD analysis indicated temperature gradients within air cavity of the investigated DSF types in 3D form, as well as air velocity and airflow patterns, as seen in Fig. 3. CFD analysis results for multistory DSF show that when exterior temperature is -18°C, the temperature in the air cavity fluctuates between -17.7°C to -15.3°F, and the upper part of the cavity demonstrated higher temperature. The velocity was relatively stable within the air cavity. Inlet velocity was 4.9 m/s and outlet velocity was 5.9 m/s, and the increased velocity can be caused by the stack effect. When exterior temperature was increased to -1°C, air temperature inside the cavity was -1.0°C to 2.9°C. If the exterior temperature was increased to 16°C or 32°C, temperatures within the cavity fall within the range between 15.7°C and 19.7°C, and 32.3°C and 36.2°C. The simulation results demonstrate a consistent temperature change pattern. Within the cavity of multistory DSF, there is a temperature fluctuation caused by solar radiation, exterior and interior temperature, as well as the ventilation effects. However, the temperature change is not significant mainly because of the configuration characteristics of multistory DSF.

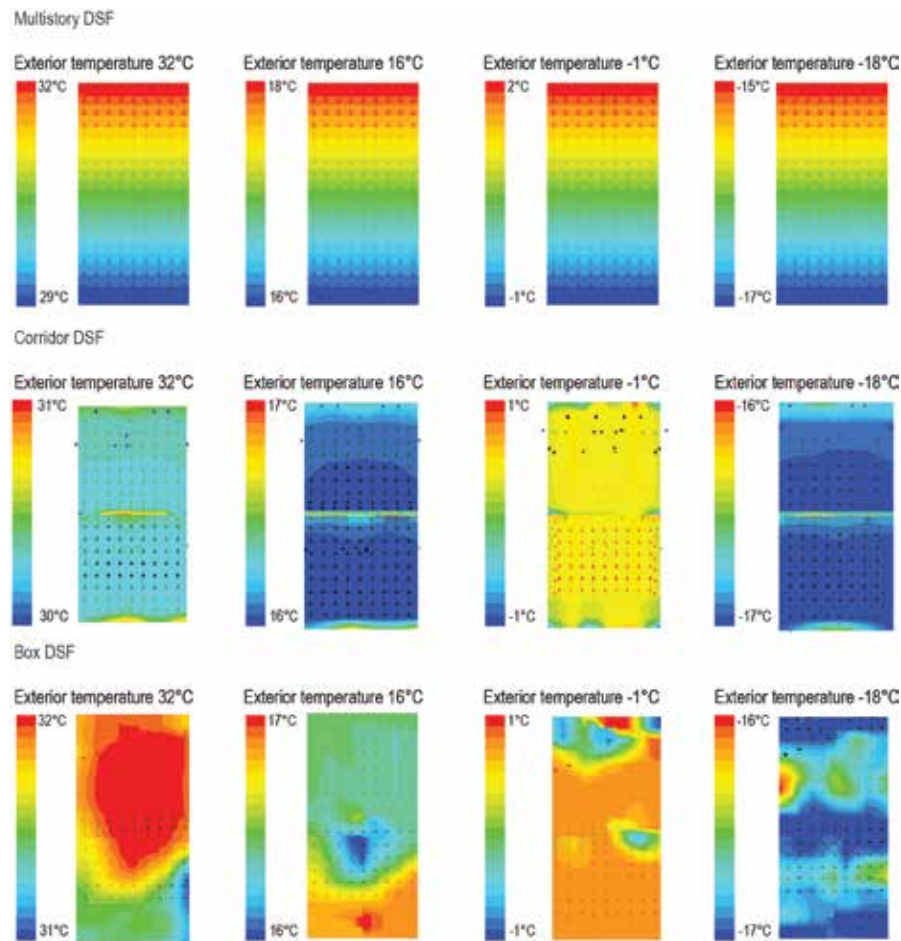

FIG. 3 CFD analysis results for investigated DSFs

Compared to multistory, corridor type DSF showed similar rising trend in cavity temperature. With exterior temperature of -18°C , the cavity temperature fluctuated between -17.7°C and -17.3°C . With exterior temperature of -1°C , the temperature inside the cavity was between -7.3°C and 1.8°C , which is lower than the temperature gradient for multistory DSF. In addition, with exterior temperatures of 16°C and 32°C , the temperatures within the cavity area fluctuated between 15.6°C and 16.3°C , and 31.7°C and 33.8°C , respectively. The cavity temperature also showed discrepancies in the lower and upper parts. The higher temperature in the upper part of DSF cavity indicates that the heat rises. Moreover, airflow patterns were different from multistory DSF due to the addition of horizontal partitions between floors. This caused more turbulence within the air cavity.

The results for the box DSF indicate that the cavity temperatures are relatively constant. With exterior temperature of -18°C , the temperature within the cavity fluctuates between -17.7°C and -17.0°C . When exterior temperature increased to 16°C , cavity temperature showed a range between 15.5°C and 16.2°C . Also, for the exterior temperature of 32°C , the cavity temperature was between 32.0°C and 32.2°C . The smaller ranges in temperatures could be due to the geometry and components of the box window DSF, since this typology has horizontal and vertical divisions that limit the movement of air within the cavity. However, these components influence airflow patterns and create more turbulence than other types of DSFs.

3.3 ENERGY MODELING RESULTS

Although benefits of DSFs in temperate and heating dominated climates have been reported in numerous earlier studies, this study investigated the effects of DSFs on energy consumption in all climate types. As stated earlier, the methodology consisted of modeling annual energy consumption of a south-oriented office space, which would be enclosed by the investigated facade types. Two sets of models were developed—representing two levels and four levels. This was necessary to accurately depict the application of the multistory facade. Results for heating, cooling, interior lighting, interior equipment and fans were calculated, as well as total energy consumption.

Fig. 4 shows results for all climates and analyzed facade types (four level models), where EUI is depicted. All types of DSF performed better than the base case, single skin conventional curtain wall. Both the two level and four level DSFs demonstrate considerable energy savings when compared to the base case models. However, there are slight variations between different types of DSF. But, there are variations in performance based on climate subzone.

Fig. 5 shows annual energy consumption for all climate types and facades, where heating, cooling, lighting, equipment and fan loads are presented. It should be noted that the lighting loads are identical in all cases since the investigated models represented an office space that would be 4 m deep. In all of these scenarios, sufficient amount of daylight would be available for the interior space. However, DSFs generally perform worse than single skin facades in providing daylight, since the two glazed skins reduce the amount of visible light that can be transmitted to the interior space. The author is currently investigating energy performance for a deeper office space to determine the effects on lighting. The author is also investigating the effects of DSF typologies, orientations and air cavity depth on available daylight in different climate types, where daylight simulations are used to compare performance of a conventional curtain wall and different DSF types. The results of that research will be reported at a later time. However, there are significant variations in heating and cooling loads, depending on the climate and investigated facade types. There are slight variations in equipment and fan loads.

These results indicate that all DSF types would improve energy performance compared to the base case scenario (standard curtain wall). The energy savings vary depending on the climate type, as well as the effects on heating and cooling loads. However, general trend that can be observed is that in heating-dominated climates, heating loads are significantly reduced, as well as cooling loads since DSFs have improved thermal performance. In cooling-dominated climates, cooling loads for the interior space are also lower for scenarios with DSFs. This also relates to improved thermal performance and lower heat transfer coefficients of DSFs compared to single skin. However, the study only considered natural ventilation for the air cavity and did not take into account mechanical ventilation of the air cavity when it may become overheated. If mechanical fans are used to exhaust air from the air cavity and assist natural stack effect in extremely hot weather, this would impact the overall cooling loads.

Results also show that there is very little variation in energy consumption between different types of DSFs (box window, corridor type and multistory) for the analyzed south-oriented office space. Variations might be more prominent for a scenario that considers deeper space, since the effects on daylight would be different due to different components and variations between these types of DSFs. The author is currently conducting a study to investigate energy consumption of these different types of DSFs in larger office space, as well as the effects of different orientations (north, east, west and south), air cavity depth and sky conditions (sunny sky, intermediate and cloudy) on available daylight. Results will be reported in a future study.

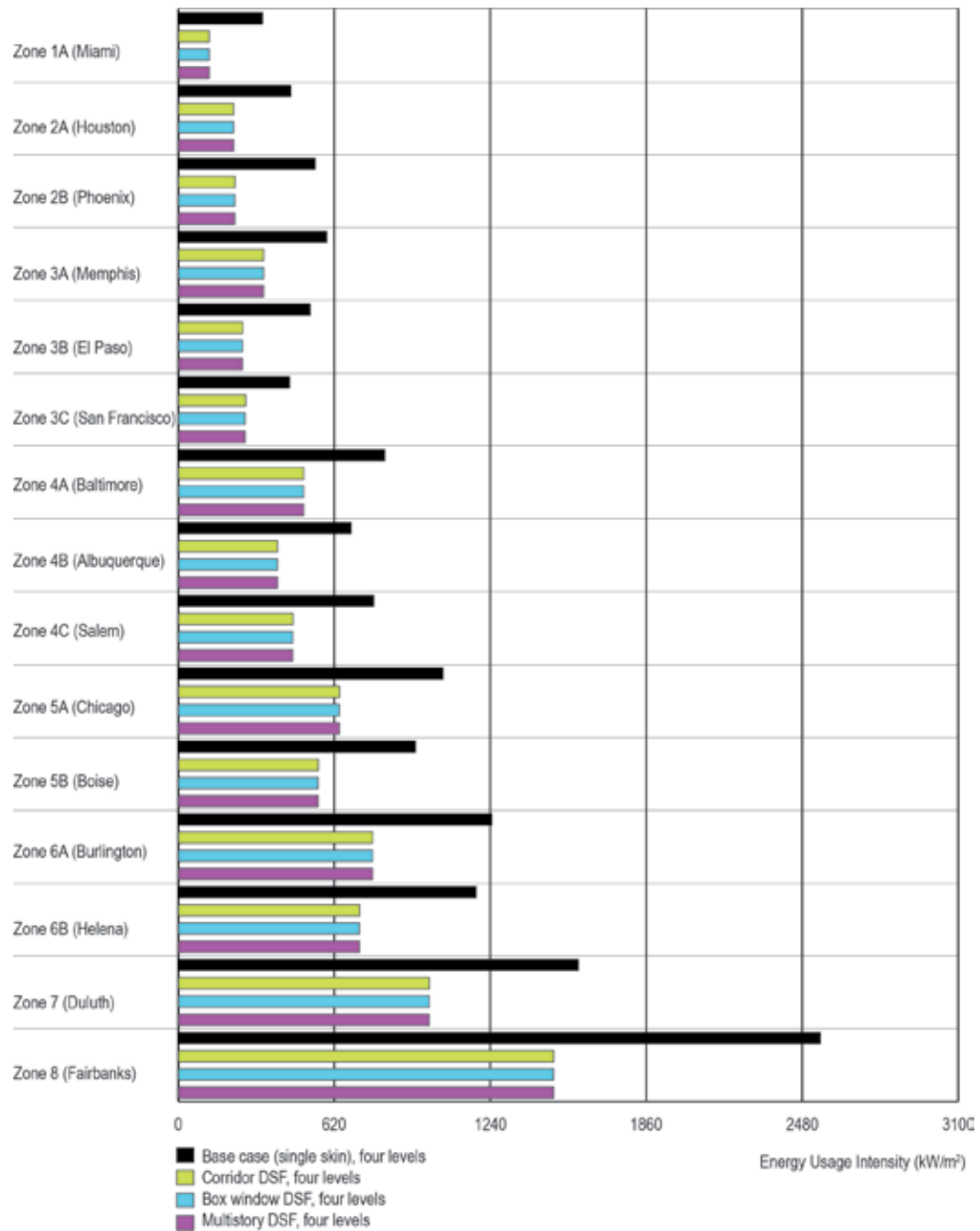

FIG. 4 Energy modeling results, showing EUI for investigated DSFs and different climate types

4 CONCLUSIONS

The purpose of this research was to investigate thermal performance of different types of DSFs, and to investigate their effects on energy performance in all climate types. The research addressed several aspects: 1) thermal performance of different types of DSFs (box window, corridor type and multistory); 2) the effects of outside temperature and solar radiation on air cavity temperature and airflow patterns within the air cavity of different types of DSFs; 3) energy performance of DSFs in different climate types; and 4) the effects of DSFs on heating and cooling loads.

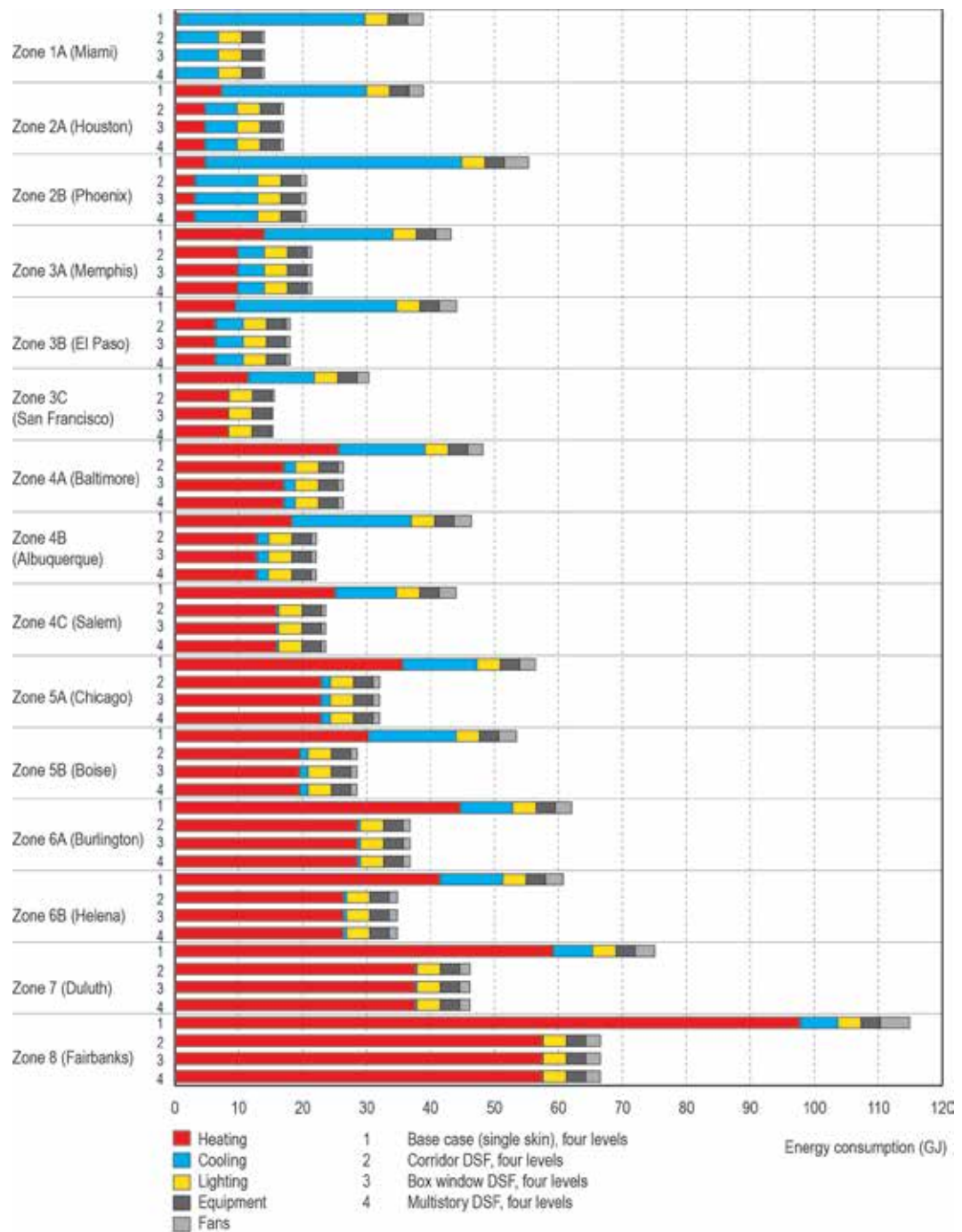

FIG. 5 Energy modeling results, showing annual energy consumption for investigated DSFs and different climate types

Research methods consisted of simulations and modeling, where different modeling techniques were used for specific parts of the study. Specifically, 2D heat transfer analysis was used to investigate thermal behavior of analyzed facade types under varying exterior temperatures, and to calculate heat transfer coefficients. CFD analysis was used to determine 3D heat flow within the air cavity of investigated DSFs, as well as airflow patterns and air velocity. Energy modeling was used to investigate energy performance, where south-oriented office space was modeled for all different climate types, which would be enclosed by the investigated facades. The base case considered single skin facade, consisting of a standard curtain wall.

Results indicate that the components and the assembly of DSFs would affect their thermal performance; however, lower U-values would be achieved compared to a standard curtain wall. Also, heat transfer analysis and CFD analysis results show temperature within the air cavity under various exterior temperature conditions. Comparison of 2D heat transfer and CFD analysis results indicated variations in results, which can be accounted to different calculation methods. Heat transfer analysis considers 2D convective heat transfer, while CFD analysis considers 3D heat transfer and takes into account radiation, convection and the effects of wind on naturally ventilated system. CFD analysis results also show air flow patterns for investigated DSF types and under various exterior temperature conditions. CFD results demonstrated a consistent temperature change pattern for the analyzed DSFs, where higher temperatures would be present in the upper parts of the air cavity. However, airflow patterns would be different for investigated DSF types. Box window and corridor DSFs exhibited higher turbulence within the air cavity, which would be caused by geometry and components, specifically horizontal divisions between floors (and vertical partitions in the case of box window DSF). Moreover, different facade orientations would have different solar exposures, which should be taken into account during design process. This study considered south-oriented facades, but impacts on the north, east and west orientations would be different. North orientations would have lower solar exposure (in northern hemisphere), while east orientation would have higher solar exposures in the morning, and west would have higher exposures in the afternoon. Shading devices can be incorporated within the air cavity to control solar heat gain, but they would impact temperature and air flow patterns.

Results of energy modeling showed that all DSF types would improve energy performance compared to the base case scenario (standard curtain wall). However, the energy savings vary depending on the climate type. In heating-dominated climates, heating loads are significantly reduced, as well as cooling loads due to lower U-values of investigated DSFs. In cooling-dominated climates, cooling loads are also lower for DSFs. Results also indicate that there is very little variation in energy consumption between different types of DSFs (box window, corridor type and multistory DSF) for the analyzed south-oriented office space. Variations might be more prominent for a scenario that considers deeper office space, since the effects on daylight would be different due to different components and variations between various types of DSFs. The author is currently conducting a study that considers these aspects, and the results will be reported at a later time.

References

- Aksamija, A. (2013). *Sustainable facades: design methods for high-performance building envelopes*. Hoboken: John Wiley & Sons.
- Pomponi, F., Piroozfar, P., Southall, R., Ashton, P., & Farr, E. (2016). Energy performance of double-skin façades in temperate climates: a systematic review and meta-analysis. *Renewable and Sustainable Energy Reviews*, Vol. 54, pp. 1525-1536.
- Gratia, E., & De Herde, A., (2007). Are energy consumptions decreased with the addition of a double-skin?. *Energy and Buildings*, Vol. 39, pp. 605-619.
- Gelesz, A., & Reith, A., (2015). Climate-based performance evaluation of double skin facades by building energy modelling in Central Europe. *Energy Procedia*, Vol. 78, pp. 555 – 560.
- Eicker, U., Fux, V., Bauer, U., Mei, L. & Infield, D., (2008). Facades and summer performance of buildings, *Energy and Buildings*, Vol. 40, pp. 600–611.
- Guardo, A, Coussirat, M., Valero, C., & Egusquiza, E., (2011). Assessment of the performance of lateral ventilation in double-glazed facades in Mediterranean climates, *Energy and Buildings*, Vol. 43 (2011): 2539–2547.
- Brandl, D., Mach, T., Grobbauer, M., & Hochenauer, C., (2014). Analysis of ventilation effects and the thermal behavior of multifunctional facade elements with 3d cfd models, *Energy and Buildings*, Vol. 85, pp. 305–320.
- NFRC (2004). NFRC 100-2004: Procedure for determining fenestration product u-factors, National Fenestration Rating Council.
- ASHRAE (2014). ANSI/ASHRAE/IES/USGBC Standard 189-2014: Standard for the design of high-performance green buildings, Atlanta: American Society of Heating, Refrigerating, and Air Conditioning Engineers.
- ASHRAE (2013). ANSI/ASHRAE/IES Standard 90.1-2013: Energy standard for buildings except low-rise residential buildings, Atlanta: American Society of Heating, Refrigerating, and Air Conditioning Engineers.

How Material Performance of Building Façade Affect Urban Microclimate

Ata Chokhachian¹, Katia Perini², Mark Sen Dong³, Thomas Auer⁴

- 1 M.Sc. Arch, Chair of Building Technology and Climate Responsive Design, Technical University of Munich, Arcisstraße 21, 80333 München, Tel. +49 89 289 22403, e-mail: ata.chokhachian@lrz.tum.de
- 2 Adjunct Professor and Post-doc researcher, Department of Architectural Sciences, University of Genoa, Stradone S. Agostino 37, 16123Genova, Italy, Tel. +390102095861, e-mail: kperini@arch.unige.it
- 3 M.Sc. ACBT, Scientific Researcher, Chair of Building Technology and Climate Responsive Design, Technical University of Munich, Arcisstraße 21, 80333 München, Tel. +49 89 289 22403, e-mail: sen.dong@lrz.tum.de
- 4 Prof. Dipl.-Ing., Chair of Building Technology and Climate Responsive Design, Technical University of Munich, Arcisstraße 21, 80333 München, Tel. +49 89 289 22475, e-mail: klima@lrz.tum.de

Abstract

The world has experienced extreme urban growth in the last and current centuries, since more than half of the world population living in urban areas. Cities are expanding toward megacities with higher densities and narrower urban canyon profiles with huge urban structures and building masses. The transformation of urban landscape to densified city blocks has created phenomenon known as urban heat island (UHI); where the temperature in cities in comparison to rural, records high differences during day and night. Within this respect, this study explores the urban canyon profile as microclimate, considering the thermal performance of the building façade, the heat exchange between the building and canyon surfaces as thermal masses. A parametric methodology implemented to study differentiation of six scenarios for façade material with different solar absorption, to narrow down between possible alternatives and find the optimized solution to have improved microclimate. Universal Thermal Climate index (UTCI) is being used to measure microclimate and outdoor comfort to monitor the temperature difference with combining air temperature, humidity, mean radiant temperature and wind speed in the urban canyon.

Keywords

Material Performance, Façade Materials, Urban Canyon, UHI, UTCI

1 INTRODUCTION

Due to rapid urbanization in most of the countries all over the world, environmental factors are getting more attention in cities. One of the main influential factors on environmental conditions in city scale is density of built environment. Achieving proper density is always a challenging question for city planners and urban designers, since there is a demand for high density to increase mobility and less energy consuming transportation. This vision will push toward denser urban fabrics. On the other hand densified cities are experiencing more urban heat island effect during the year, while the city cannot cool down during night. Urban Heat Island (UHI) is one of the most common manifestations on urban climate studies and since its advent by Luke Howard (1818), it is still the topic of researchers in different regions of the world. High levels of pollution in the atmosphere and the “cementification” of urban areas (an excess of asphalted, or “low albedo”, areas relative to green areas) cause the UHI phenomenon resulting in the dramatic 2 to 8 degree Celsius temperature differences between cities and their surrounding suburban and rural areas (Taha, 1997). In urban scale, morphology of a city influence micro climate parameters such as direct and indirect solar radiations, air temperature, mean radiant temperature, humidity and wind. that is why built environments are known as one of the climate modifiers (Horrison & Amirtham, 2016). Urban geometry and thermal properties of canyon surfaces have been found to be two main influential parameters on urban micro climate (Arnfield, 2003; Oke, 1988). The ration between height of the buildings (H) and the distance between them (W) affects the amount of solar radiation being absorbed and reflected from the surfaces in the canyon; also this effects the direction and speed of wind. There is a direct relation between H/W ratio and sky view factor. If H/W increases, this will reduce SVF, as consequence the reflected outgoing long wave radiation decreases and ends up with higher UHI. Another important factor is the material of the building surfaces in the canyon, studies proved that high thermal capacity of the materials act as thermal mass and absorb large amount of radiation during the day and stores it, and sometimes could not be released until the night (Johnson et al., 1991a, 1991b). There are couple of other factors like anthropogenic heat released from vehicles and air-conditioning systems, as well as air pollution, which has small effect on the radiation but not directly on air temperatures, and these effects are usually proved to be small (Arnfield, 2003).

Studies show that form of the built environment and properties of the surface materials in urban canyons have physically strong effect on the micro climate of cities. Early stages of urban design could be promising area for addressing thermal comfort and outdoor comfort to have livable public spaces. However microclimate of the cities in design process has gained minimum importance in the planning of cities (Evans & Schiller, 1996). This lack is firstly because of having no proper and accurate tools for early stages of urban design in order to justify micro scale parameters, and secondly, complexity and time consuming simulation procedures made this process even more far from main decision making steps of design process. In recent years the necessity of focusing on micro scale in urban studies has achieved more popularity. Johansson (2006) investigated the influence of urban geometry on outdoor thermal comfort by comparing an extremely deep and a shallow street canyon in Fez, Morocco and concluded that, in hot dry climates a compact urban design with very deep canyons is preferable. Horrison and Amirtham (2016) quantified the impact of urban growth pattern characterized by orientation, ground cover, street geometry on variations in climate parameters and their study established a clear relationship between urban character and microclimate modifications. Ali-Toudert and Mayer (2006) contributed to aspect ratio and solar orientation, towards the development of a comfortable microclimate at street level for pedestrians. Within the existing research context, still there is a room for more research and practical study on detailed effect of built environment on outdoor comfort. This research aims to cast more light on material modification of building surfaces in urban canyons to monitor the behavior of changing parameters on mean radiant temperature and air temperature inside the canyon as well as outdoor comfort indices with coupling methodologies.

2 OUTDOOR COMFORT

In recent decades there is a quite well understanding of the link between microclimate and urban settlements. Improved outdoor thermal conditions are in direct connection with how people behave and use outdoor spaces, this reaction may be spontaneous but mankind knows how to get adapted to different climate conditions in urban spaces. Having a place with optimum comfort level will enhance the city in different direction such as: encouragement for cycling and walking, attracting more number of people to comfort zones in the city and turning this opportunity into business and tourist attractions to shift the area economically profitable (Nikolopoulou, Baker, & Steemers, 2001). Within this respect comfortable outdoor space could be achieved with set of strategies according to the context like, planting trees with the advantage of evaporative cooling plus shading effect or adding manmade canopies with local materials are some of the possible solutions. Being comfortable or feeling like having no thermal stress is dependent on several factors and parameters and at the same time it differs from each person to another one, but scientifically if the body reaches thermal equilibrium with the surroundings, then the feeling should be close to comfort zone. In urbanized regions the lowest part of the atmosphere is known as urban boundary layer (UBL), which is certainly affected by the nature of building typologies. The UBL is mainly divided into smaller sub layers according to its climatic considerations and fundamentals, and the lower part is where microclimate studies are being done. Figure 1 shows a conceptual sketch of effective parameters on outdoor comfort in urban canopy layer.

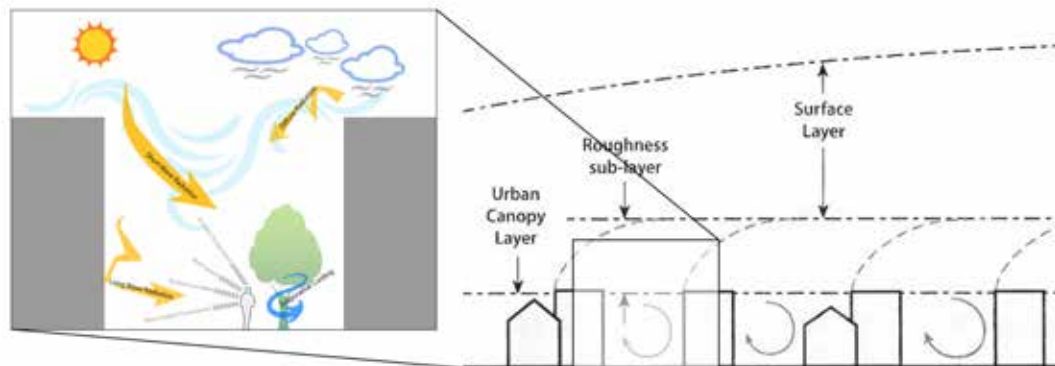

FIG. 1 Conceptual sketch of outdoor comfort and effective parameters

One of the sub layers of UBL is surface layer that goes up to about four or five times of average building height in urban areas. The effective parameters on this layer are known as three-dimensional geometry of the buildings and other attributes on the ground cover. This layer forms when the air has passed over a sufficient length of urban structures and attributes, including the heat generated within the city and rough sharp-edged structures (Erell, Pearlmutter, & Williamson, 2012). Below the surface layer and usually twice the average building height, the roughness sub-layer stands and it is highly variable because of different building heights, vegetation and open space variations. This zone is known as the transition layer between the highly vibrant urban surface and homogenous surface layer. The lower part of this roughness sub layer and urban atmosphere (UCL) starts from ground level and goes up to height of buildings, trees and other urban structures. In contrast to surface layer, the urban canopy layer is highly heterogenic since the conditions alter from point to point within the city boundaries. Corresponding to heterogenic essence of UCL, the necessity of establishing unique microclimate according to characteristics of each urban region such as; site parameters, vegetation, building typologies/systems, construction material and etc. is undoubtful. The relation between microclimate and architecture is reciprocal, in other words, the architectonic representation of the built environment impacts the outdoor thermal comfort, and on the other hand, the climate of the urban region impacts the building energy loads and consumptions. This research focuses on urban canopy layer to see the effect of built environment and surface materials on microclimate of city.

2.1 OUTDOOR COMFORT INDICES

Thermal comfort sensation in terms of outdoor perceived very differently from indoor comfort and people tend to accept a much wider range of thermal conditions outdoors than indoors. Based on conventional thermodynamic theories, comfort is steady state model which means the production of heat is equal to loss of it to the environment. This theory in reality is being adjusted by people themselves with modifying the clothing factor and the activities they do to decrease or increase the metabolic rate. Since the outdoor comfort is outcome of complex parameters, there have been very few attempts to define, scale and investigate outdoor comfort numerically. One of the most common indices is predicted mean vote (PMV) developed by Fanger (1973), the idea is based on the assumption that comfort is only reached and maintained at thermal equilibrium in the defined environment and boundary conditions. It is based on a steady-state heat balance model, empirically fitted to the sensation vote on a seven-point scale of a group of human test subjects exposed to static conditions in a controlled indoor environment. Standard effective temperature (SET) is another adjusted temperature scale meant to reflect the heat stress or cold felt by the occupant, and it is scaled in degree Celsius. In this model the total heat loss from the skin of an imaginary conditioned occupant is same with a person staying under the input conditions. Physiological Equivalent Temperature (PET) is another scale introduced by Mayer and (Höppe, 1999) and compares complex outdoor conditions to a typical steady-state indoor setting with the presets of MRT equal to T_a , wind speed of 0.1 m/s, Vapor Pressure of 12 hPa or RH=50% at $T_a=20^{\circ}\text{C}$. The critical point among all of these indices and scales is that, using steady state models for assessment of outdoor comfort may not be correct solution since outdoor climate varies much more, temporally as well as spatially, values of the climate elements are usually very different from indoor values, and their relative influence can also be very different. Moreover, physiological adaptation of a person entering a climatically different environment takes some time and those models tend to overestimate discomfort values (Fiala, Lomas, & Stohrer, 2001). One of the recently developed indices for thermal comfort assessment is Universal Thermal Climate Index (UTCI) based on a dynamic physiological response model (Bröde, Jendritzky, Fiala, & Havenith, 2010). UTCI is this temperature of what the weather "feels like" and it takes into account radiant temperature (usually including solar radiation), relative humidity, wind speed and uses them in a human energy balance model to give a

temperature value that is indicative of the heat stress or cold stress felt by the human body. For the calculations of Universal Thermal Climate Index the following simplified equation (UTCI) was applied (Błażejczyk, 2011).

$$UTCI = 3.21 + (0.872 \cdot t) + (0.2459 \cdot MRT) - (2.5078 \cdot V) - (0.0176 \cdot RH) \quad (1)$$

Where: t is air temperature (°C), MRT is Mean Radiant Temperature (°C), v is wind speed at 10 m above ground (m/s⁻¹), RH is Relative Humidity of air (%). Figure 2 shows different outdoor comfort indices scales in respective order.

PMV (INDOOR)	PET (GERMANY)	UTCI	SENSATION VOTE
	<4	<-40	Very cold
		-40--27	
-3	4-8	-27--13	Cold
-2	8-13	-13-0	Cool
-1	13-18	0-9	Slightly cool
0	18-23 (temp range for indoor comfort)	9-26	Comfortable/ neutral
1	23-29	26-32	Slightly warm
2	29-35	32-38	Warm
3	35-41	38-46	Hot
		>46	
	>41		Very hot

FIG. 2 Comparison of thermal indices PMV, PET and UTCI. (Pijpers-van Esch, 2015)

3 SURFACE MATERIAL PROPERTIES

Couple of studies already delivered on the effect of urban canyon material on outdoor comfort. Salata, Golasi, Vollaro, and Vollaro (2015) prove that the application of high albedo materials on vertical and horizontal faces of a canyon determines deterioration of thermal comfort especially in summer. This phenomenon could be handled by increasing the sky view factor of high albedo materials to limit the radiation reflection inside the canyon. In contrast, high albedo materials usually improve microclimate during winter. This improvement is directly in connection with the climate, because the improvement is not exactly equal to worsening that happens during the summer and most of the time it has less effect on winter. Dessì (2011) did an investigation considering performance of materials in terms of surface temperature to mitigate UHI effect. The research admits during the sunny day the surface temperature increases as the albedo decreases. Clear and smooth materials like marble have surface temperature similar to air temperature and they behave as they are in shadow. It is believed that using clear materials is one of the popular strategies to reduce the UHI effect as they don't heat up that much and reflect solar radiation. Nevertheless, clear surfaces create problems such as visual discomfort inside the canyon. More severe problem is related to the thermal comfort and mean radiant temperature (MRT). The solar radiation reflected from clear materials, like the marble and glass surfaces, can be easily redirected into the canyon depending on the sky view factor. In the heat balance we have MRT with the whole radiation including direct and diffuse. It's true that the marble absorbs 20% of radiation and its surface temperature is always quite low, but we cannot ignore that the 80% reflects back to the canyon and can hit other urban surface on the space users.

4 METHODOLOGY

4.1 SELECTED STUDY AREA

The research concentrates on typical urban block located in Munich city center having mid-rise density surrounding with same height buildings. The urban canyon simulated with dimensions of 21 meters width, 75 meters length and buildings with 21 meters height (Fig. 3). Meteorological data (air temperature, relative humidity, wind speed, and wind direction) used for simulations gathered from the station in city center located near to study area(LMU Weather station), and selected period for study was typical hot summer day in last 10 years (12 August). Verification of surface materials is considered as concrete, brick and exterior insulation in order to measure different albedo and thermal mass effect.]

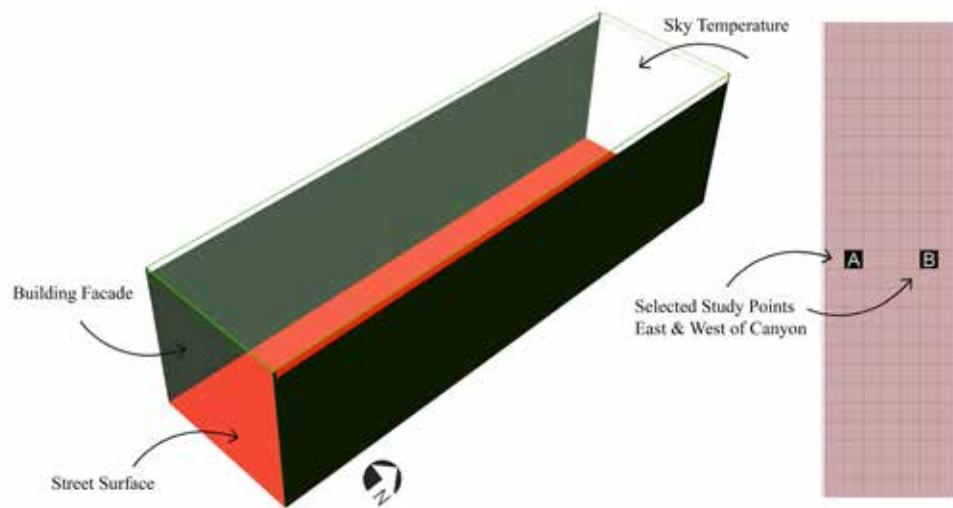

FIG. 3 3D model of urban canyon

4.2 SIMULATIONS

Each simulation tool has its own advantages and short comings, so coupling strategies implemented in order to maximize accuracy of results for each parameter. The process could be divided into three parts, first part of the simulation is done with ENVI-met to calculate relative humidity and wind speed since ENVI-met is accurate in CFD modeling (De Maerschalck, Maiheu, Janssen, & Vankerkom, 2010). Second part is done with TRNSYS version 17.1 to simulate effect of different surface materials on mean radiant temperature and air temperature inside the canyon. For both simulations the same model implemented with same dimensions and properties. Last step was bringing results from two different simulation environments into one layer and overlap them to map outcomes. This was done with grasshopper as visual programming interface to read data from both simulations and map outdoor comfort visually as well as calculating values numerically (Fig. 4). Each simulation tool has certain boundary conditions, in case of TRNSYS: Weather data: try2010_13y_muehldorf.109, Analysis time span: 12th August 0-23hr, Ground Boundary Temperature: 20°C, Wall Boundary Temperature: Tamb, Wall Adjacent Temperature: 23°C, and Ceiling Boundary Temperature: Tsky.

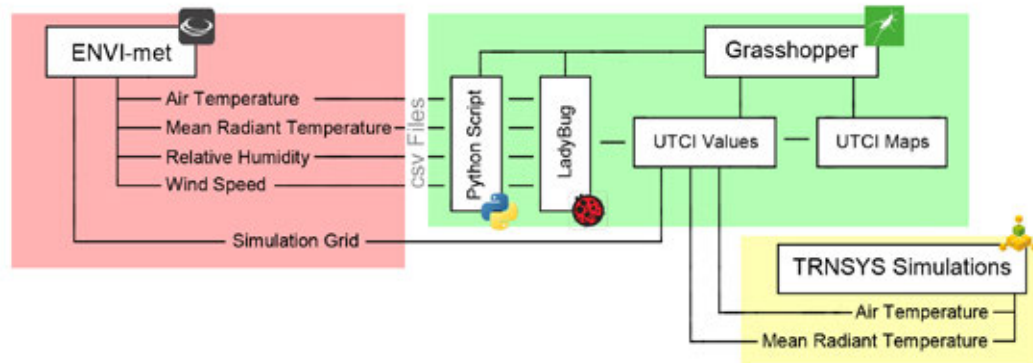

FIG. 4 Diagram of Coupling Methodology implemented tools

4.3 MATERIAL THERMAL PROPERTIES

Thermal simulations are dynamic in terms of material variation, for this reason there is possibility to evaluate different materials with varying solar absorption to see their impact on energy performance of urban space. This will help to select correct materials for building façade to have less impact on outdoor environment. Table 1 & 2 provide detailed information on material properties and construction variants for different simulations inputs. Six alternative materials are selected as input: Brick, Concrete and exterior insulation with plaster as finishing layer. The other variant was color of the materials with different solar absorption. For brick 35 and 68 percent, for concrete 30 and 80 percent, for wall with exterior insulation the color with 30 and 80 percent solar absorption implemented for TRNSYS simulations.

MATERIAL	CONDUCTIVITY	CAPACITY	DENSITY
	kJ/h.m.K	kJ/kg.K	kg/m ³
Concrete	6.12	0.88	2300
Brick	2.88	0.84	1920
EPS	0.144	1.5	32
Plaster	0.72	1	849

TABLE 1 Material Properties of Surfaces



	Wall Variants	Walls	Floor	Solar Absorption
	Concrete	Concrete 30cm	Concrete 60cm	Light 30%
				Dark 80%
	Brick	Brick 30cm	Concrete 60cm	Glazed 35%
				Common Red 68%
	External Insulation	Plaster 2cm	Concrete 60cm	Light 30%
		EPS 20cm		Dark 80%
		Concrete 20cm		

TABLE 2 Surface Construction Variants

5 RESULTS

5.1 ENERGY PERFORMANCE OF MATERIALS

Simulation inputs are divided into six different variants, considering 3 materials (Brick, Concrete, and Exterior Insulation) with two different solar absorption values for each. In order to compare the effect of each component, two test points are selected in the canyon. The points are in the pedestrian height in both sidewalks. We name west point as 'A' and the East point as 'B'. The graphs are illustrated to compare brightness and darkness of same materials by means of varying solar absorption to see how they affect MRT on local points (Fig. 4). The comparison shows that dark materials end up in less mean radiant temperature values since they absorb most of the radiation as heat and reflect minor part of it into the canyon. Here the question could be the thermal mass effect during night, which we exclude from this paper since the topic is broad enough for a whole research paper and we focus just on day time effect of materials. The results values from two test points show that as the profile of the canyon has high walls with shadow casting effect, both points heat up almost in same pattern just with some hours of differentiation. During the evening west point cools down earlier and both points get close to equilibrium before sunset.

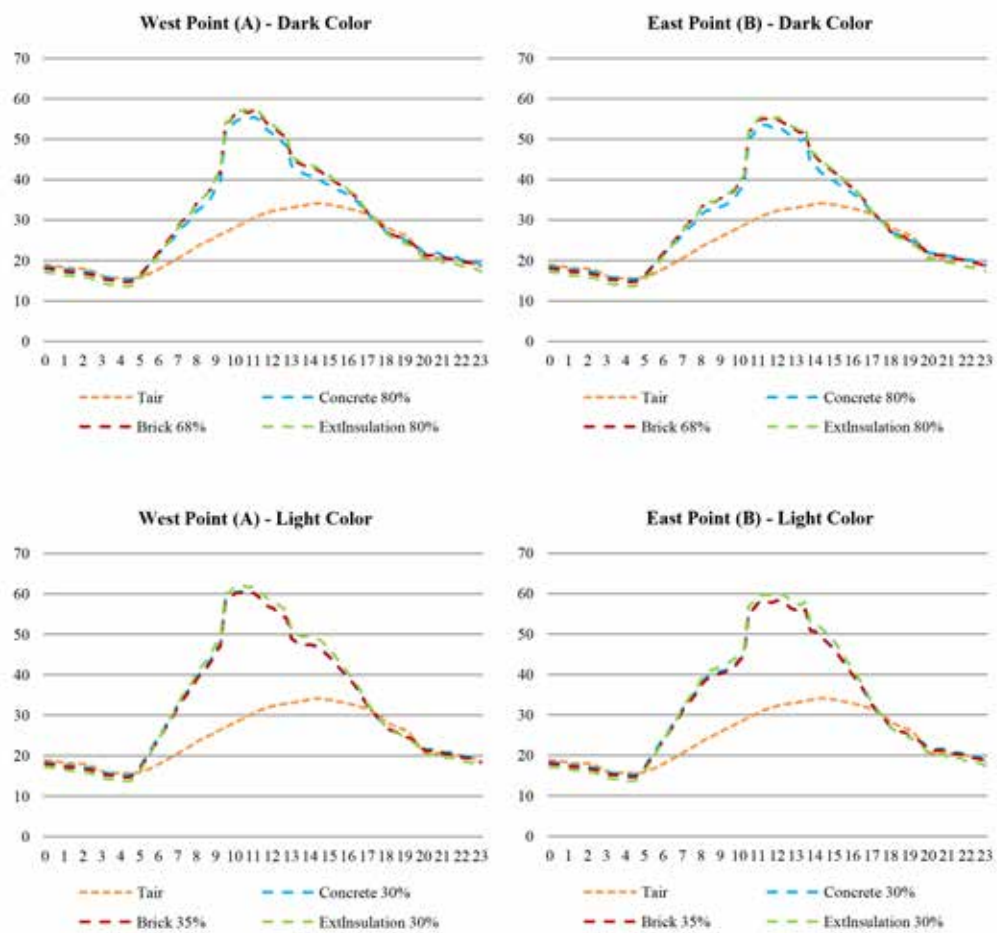

FIG. 5 MRT values for different material variants

We also monitor the highest MRT values for Exterior insulation case since the thermal mass effect of the material is minor and MRT during the day goes up to 61 °C which could be absorbed by ground and surrounding surfaces depending on sky view factor. This could be the main drive for heating the space during night time (Fig. 5). To compare the effect of material variation with different absorption values, we also map them in the canyon for 2pm. The most extreme case is with exterior Insulation with 30% solar absorption and the best case is brick wall with 68% absorption (Fig.6).

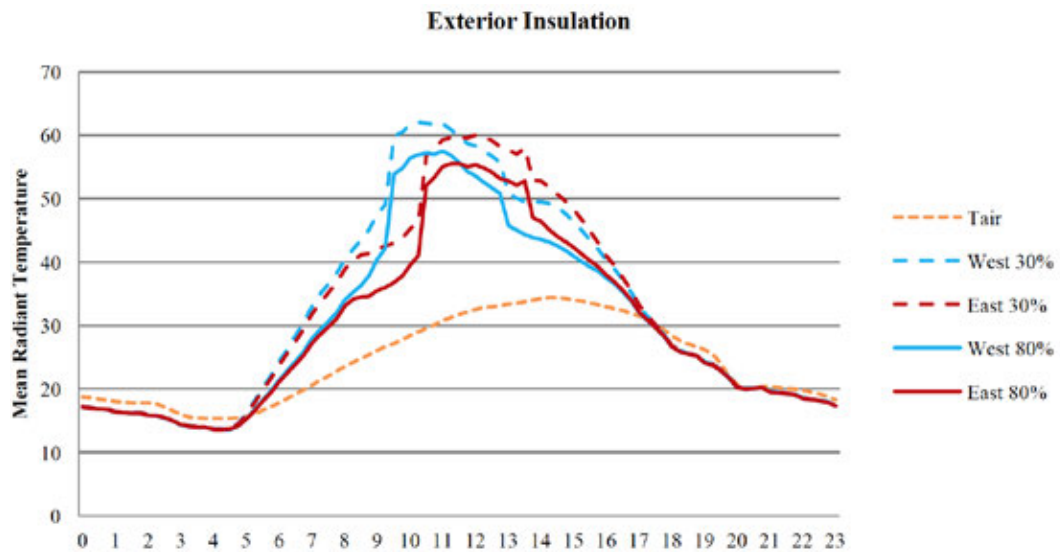

FIG. 6 Mean radiant temperature for Point A & B for Material with Exterior Insulation

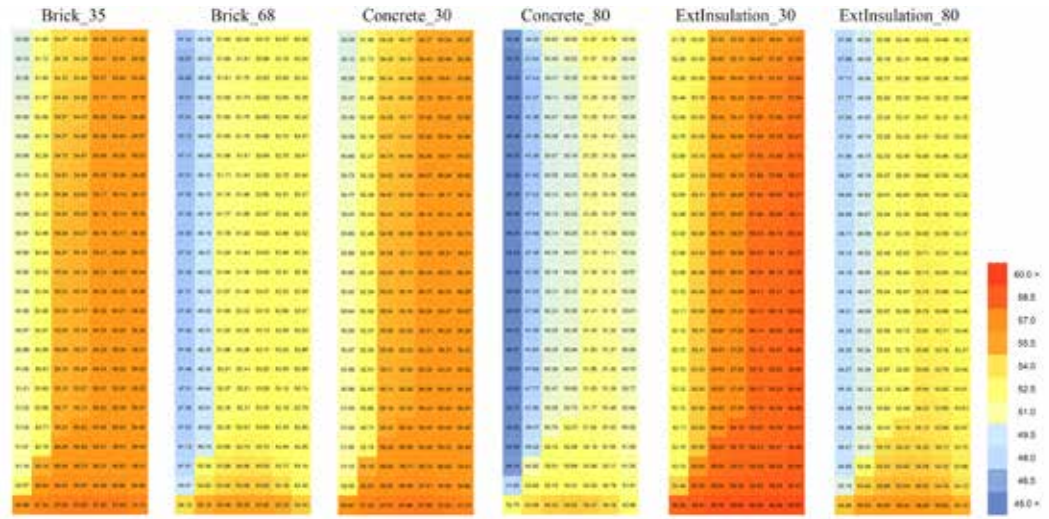

FIG. 7 Comparison of MRT values for Different facade materials

5.2 OUTDOOR COMFORT MAPPING (UTCI)

Final step was to get MRT values from TRNSYS and combine them with ENVI-met outputs to map outdoor comfort. It is also possible to get MRT directly from ENVI-met but there are some discussions going on the accuracy of the results in term of considering thermal mass of the material. Also in free version of the program there is no possibility to modify the façade material properties. That is why coupling methodology implemented by a script in Grasshopper to merge outputs of both simulations in UTCI map to define environmental performance and people well-being in urban canyon. The maps are produced for typical hot day at 2pm. Heat stress probability was calculated within UTCI values. In all cases the values are between moderate heat stress and strong heat stress. Within the alternatives, concrete material with 80 percent of solar absorption has the least heat stress; in contrast the façade with exterior insulation and 30 percent solar absorption causes the most heat stress in the canyon.

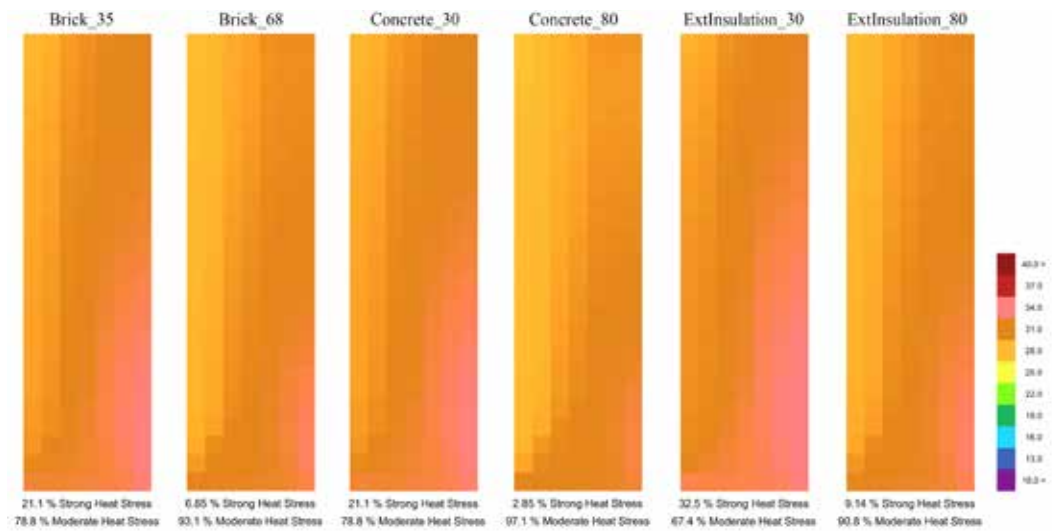

FIG. 8 Universal Thermal Climate Index for different Facade Materials

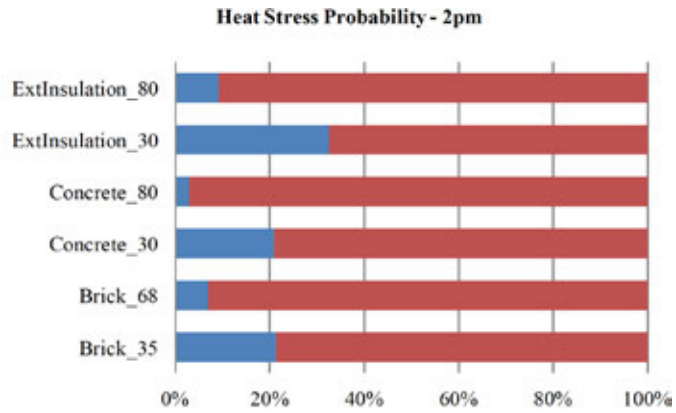

FIG. 9 Heat stress comparison of UTCI values

6 CONCLUSIONS

Material choice is one of the main role playing factors in terms of having less impact on environment. Each selection depends on where we are going to use the material. For example, high reflective materials can reduce temperature of urban surfaces like roofs and pavements as well as summer time building cooling energy demand. At the same time high albedo materials absorb less radiation and this increases MRT depending on sky view factor in day time. Studies find that reflected radiation from high-albedo pavements can increase the temperature of nearby walls and buildings, increasing the cooling load of the surrounding built environment and increasing the heat discomfort of pedestrians. Harmful reflected UV radiation and glare, unintended consequences of reflective pavements, need special consideration for human health (Yang, Wang, & Kaloush, 2013). Results and findings through this study reveal that:

- The solar absorption, surface temperature and mean radiant temperature have proportionally reverse relationship
- The results show that with higher solar absorption, less solar radiation is reflected directly into the space and causes the space to be cooler.
- The effect of different façade materials is significantly smaller than the impact of difference between solar absorption percentages on local mean radiant temperature values
- Higher solar absorption means higher surface temperature, but lower MRT, and vice versa.
- For the climate of Munich, the results show that light color walls with less solar absorption are worse than dark color walls in terms of outdoor comfort during hot periods.

The aim of this research was not just to investigate material variation; however the developed coupling methodology with different simulation tools gives an opportunity to have more accurate simulation result depending on the input parameters. Also the frame work could be used for future studies in order to have parametric exploration on the aspect ratio of the canyon (H/W) to monitor its effect on UHI based on varying SVF as well as material differentiation with different thermal mass capacities.

Acknowledgements

We thank Daniel Kiehlmann and Wolfgang Kessling from Transsolar KlimaEngineering GmbH for the help and support given during this study with providing insight and expertise that greatly assisted the research.

References

- Ali-Toudert, F., & Mayer, H. (2006). Numerical study on the effects of aspect ratio and orientation of an urban street canyon on outdoor thermal comfort in hot and dry climate. *Building and Environment*, 41(2), 94-108. doi: <http://dx.doi.org/10.1016/j.buildenv.2005.01.013>
- Arnfield, A. J. (2003). Two decades of urban climate research: a review of turbulence, exchanges of energy and water, and the urban heat island. *International Journal of Climatology*, 23(1), 1-26. doi: 10.1002/joc.859
- Błażejczyk, K. (2011). Mapping of UTCI in local scale (the case of Warsaw). *Prace i Studia Geograficzne WGSR UW*, 47, 275-283.
- Bröde, P., Jendritzky, G., Fiala, D., & Havenith, G. (2010). The universal thermal climate index utci in operational use. Paper presented at the 6th Windsor Conference on Thermal Comfort.
- De Maerschalck, B., Maiheu, B., Janssen, S., & Vankerom, J. (2010). CFD-modelling of complex plant-atmosphere interactions: Direct and indirect effects on local turbulence. Paper presented at the CLIMAQS Workshop 'Local Air Quality and its Interactions with Vegetation'.
- Dessi, V. (2011). Urban Materials for Comfortable Open Spaces. Paper presented at the World Renewable Energy Congress, Linköping, Sweden.
- Erell, E., Pearlmutter, D., & Williamson, T. (2012). *Urban microclimate: designing the spaces between buildings*: Routledge.
- Evans, J. M., & Schiller, S. D. (1996). Conference on the Urban Thermal Environment Studies in TohwaApplication of microclimate studies in town planning: A new capital city, an existing urban district and urban river front development. *Atmospheric Environment*, 30(3), 361-364. doi: [http://dx.doi.org/10.1016/1352-2310\(94\)00138-3](http://dx.doi.org/10.1016/1352-2310(94)00138-3)
- Fanger, P. O. (1973). Assessment of man's thermal comfort in practice. *British journal of industrial medicine*, 30(4), 313-324.
- Fiala, D., Lomas, J. K., & Stohrer, M. (2001). Computer prediction of human thermoregulatory and temperature responses to a wide range of environmental conditions. *International Journal of Biometeorology*, 45(3), 143-159. doi: 10.1007/s004840100099
- Höppe, P. (1999). The physiological equivalent temperature – a universal index for the biometeorological assessment of the thermal environment. *International Journal of Biometeorology*, 43(2), 71-75. doi: 10.1007/s004840050118
- Horrison, E., & Amirtham, L. R. (2016). Role of Built Environment on Factors Affecting Outdoor Thermal Comfort - A Case of T. Nagar, Chennai, India.
- Howard, L. (1818). *The Climate of London: deduced from Meteorological observations, made at different places in the neighbourhood of the metropolis*: W. Phillips, sold also by J. and A. Arch.
- Johansson, E. (2006). Influence of urban geometry on outdoor thermal comfort in a hot dry climate: A study in Fez, Morocco. *Building and Environment*, 41(10), 1326-1338. doi: <http://dx.doi.org/10.1016/j.buildenv.2005.05.022>
- Johnson, G. T., Oke, T. R., Lyons, T. J., Steyn, D. G., Watson, I. D., & Voogt, J. A. (1991a). Simulation of surface urban heat islands under 'IDEAL' conditions at night part 1: Theory and tests against field data. *Boundary-Layer Meteorology*, 56(3), 275-294. doi: 10.1007/bf00120424
- Johnson, G. T., Oke, T. R., Lyons, T. J., Steyn, D. G., Watson, I. D., & Voogt, J. A. (1991b). SIMULATION OF SURFACE URBAN HEAT ISLANDS UNDER IDEAL CONDITIONS AT NIGHT .1. THEORY AND TESTS AGAINST FIELD DATA. *Boundary-Layer Meteorology*, 56(3), 275-294. doi: 10.1007/bf00120424
- Nikolopoulou, M., Baker, N., & Steemers, K. (2001). Thermal comfort in outdoor urban spaces: understanding the human parameter. *Solar Energy*, 70(3), 227-235. doi: [http://dx.doi.org/10.1016/S0038-092X\(00\)00093-1](http://dx.doi.org/10.1016/S0038-092X(00)00093-1)
- Oke, T. R. (1988). The urban energy balance. *Progress in Physical geography*, 12(4), 471-508.
- Pijpers-van Esch, M. (2015). Designing the Urban Microclimate. A framework for a design-decision support tool for the dissemination of knowledge on the urban microclimate to the urban design process. 2015(6), 308. doi: 10.7480/abe.2015.6
- Salata, F., Golasi, I., Vollaro, A. d. L., & Vollaro, R. d. L. (2015). How high albedo and traditional buildings' materials and vegetation affect the quality of urban microclimate. A case study. *Energy and Buildings*, 99, 32-49. doi: <http://dx.doi.org/10.1016/j.enbuild.2015.04.010>
- Yang, J., Wang, Z., & Kaloush, K. E. (2013). Unintended consequences: A research synthesis examining the use of reflective pavements to mitigate the urban heat island effect.

An investigation on the relation between outdoor comfort and people's mobility – The Elytra Filament Pavilion survey

Daniele Santucci^{1/2}, Eduard Mildenerger², Boris Plotnikov³

- 1 Technische Universität München, Department of Architecture, Chair for Building Technology and Climate Responsive Design – Prof. Thomas Auer, Arcisstrasse 21, 80333 Munich, +49 (0)89 – 28923876, Daniele.Santucci@tum.de
- 2 Technische Universität München, Department of Architecture, Research Lab, Arcisstrasse 21, 80333 Munich, Eduard.Mildenerger@lrz.tum.de
- 3 Transsolar GmbH, Landwehrstrasse 60/62, 80336 Munich, +49 89 59068840, pborisp@gmail.com

Abstract

The totality of environmental conditions regulates the use of public space and influence socio-technical questions. Among many factors that determine the quality of outdoor spaces, the outdoor microclimate is an important issue. The evaluation of these conditions demands innovative computational methodologies and tools. The challenge for designers and urban planners is thus not only how to collect, process or interpret such huge arrays of information, but to develop an integrated understanding of dependencies to prefigure vibrant urban environments. The influence of thermal comfort on outdoor activities is a complex issue comprising both climatic and behavioural aspects. This research investigates on the relation between outdoor comfort and canopy structures by mapping people's presence and their individual mobility in outdoor spaces, with the aim of finding a systematic relation. The proposed methodology was applied to the survey of the Elytra Filament Pavilion, manufactured in summer 2016 in the John Madejski Garden of the Victoria & Albert Museum in London. Through data mining, the final aim is to provide new approaches to understanding the influences of the environmental conditions and their perception on human activity and people's use of outdoor space, to create more liveable outdoor spaces.

Keywords

microclimate, outdoor comfort, data mining, canopy, mobility patterns.



FIG. 1 The Elytra Filament Pavilion, V&A Museum in London

1 INTRODUCTION

Among many factors that determine the quality of outdoor spaces, the microclimatic conditions are an essential issue. While thermal comfort in indoor conditions has been widely researched leading to specific building regulations and planning standards, the topic of thermal comfort in the outdoor realm is often times neglected. A few possible reasons could be associated to the multitude of considerations that are confronted during the urban design process, the difficulty in simulating and measuring thermal comfort outdoors and the lack of proven methodologies and tools (Höppe, P. 2002) (Gulyas et al. 2006).

In the Elytra Filament Pavilion, an experimental pavilion which comprises of a modular robotically constructed canopy commissioned by the Victoria & Albert Museum in London, a collaborative work between the ICD (Institute for Computational Design, University of Stuttgart), the ITKE (Institute of Building Structures and Structural Design, University of Stuttgart) and Transsolar climate engineering, new ways were explored to combine real time on site measurements and simulations in order to estimate the microclimate effects of the canopy and seek correlations between people's movement and thermal comfort.

The aim of this research is to find a systematic relation between outdoor comfort and people's presence and their individual mobility. Following the hypothesis that microclimate highly influences the use of outdoor spaces, it aims to outline the impact of a canopy on outdoor comfort conditions. Through the prediction of human comfort in outdoor spaces, the rules of relating people flows and microclimatic conditions are put into evidence.



FIG. 2 The Elytra Filament Pavilion, V&A Museum in London

2 METHODOLOGY

The following section will focus on the methodologies used to gather information regarding occupant behaviour and thermal comfort. Two main sections compose the methodology:

- **Microclimate – outdoor comfort model:**

The variation of urban microclimate in a specific context in relation to recorded weather data available from weather stations. Outdoor comfort models require precise microclimate data to determine conditions with a high resolution.

- **Sensing:**

People flows in public spaces can be captured and mapped through GPS tracing devices. In Europe, the issue of privacy is extremely relevant and accessing this data is difficult. New technologies based on video content analytics enable quick image processing. Its main components are a camera sensor and a software module that only analyses shapes without interferences with security and privacy reasons.

As a second step, a comfort model is created basing on microclimate simulation and through data analysis; correlations are pointed out in order to investigate following purposes:

- Validating existing thermal comfort models by providing an empirical automated system as opposed to questions that predicts thermal comfort of occupants.
- Provide a framework for gathering and analysing real time information for existing built environments in order to monitor their performance.
- Promote the idea of responsive skins in the built environment - by analysing weather factors such as radiation, wind, humidity and temperature alongside information about where people are located, adjustable building skins would lead to more adaptable and comfortable micro climates.

3 EXPERIMENT

3.1 THERMAL COMFORT INFORMATION

In order to access the thermal comfort conditions, we have used the UTCI (Universal Thermal Climate Index): an index which is commonly used to evaluate thermal comfort in outdoor conditions and which takes as an input five parameters - air temperature, mean radiant temperature, water vapour pressure, relative humidity and wind speed in a height of 10 meters above ground level. UTCI values were calculated for every canopy element in order to better understand the microclimatic conditions that the structure determines (Chen, L. et al 2012).

For the water vapour pressure value we used the standard atmosphere value of 01.325 kPa. Air temperature, wind speed and relative humidity were retrieved from a nearby weather station in five-minute intervals. The process of estimating the mean radiant temperature required a few more steps. We conducted a radiation simulation using Honeybee and Daysim (Reinhardt 2011) for a five minute interval between May and November (the time frame of the pavilion exhibition). As a following step, we calculated the relative radiation values based on the global horizontal radiation values from the weather file used for the simulation. Therefore, for instance, if the global horizontal radiation value in the weather file was 800 Wh/m² for a certain time, and the simulated radiation for a test point was 400 Wh/m², the radiation percentage was 50%.

As a following step, we retrieved the global horizontal radiation from the same meteorological station and for the corresponding time multiplied the actual global horizontal radiation with the radiation percentage. This method offered a simplified model for estimating local radiation values, although further research should be conducted to measure the reliability of this method. Once we calculated the radiation values, we estimated the mean radiant temperature using the „Human Bio-Meteorological Chart“ (Kessling, et al. 2013).

At this stage the UTCI values for all of the test points were calculated and stored in a database.

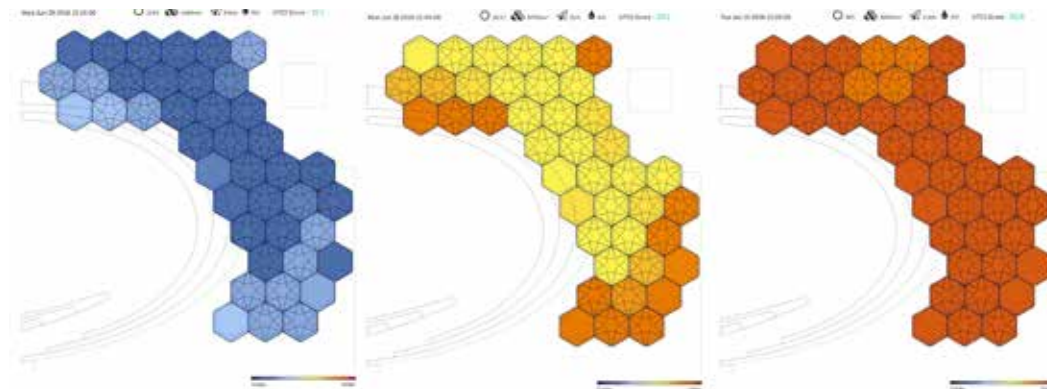

FIG. 3 Thermal comfort mapping – Example of three different frames

3.2 OCCUPANCY INFORMATION

Several limitations involving the museums regulations led to seeking solutions that would be as transparent as possible for the occupants and will not store any personal information. The use of infrared cameras, thermal imaging or Wi-Fi tracking was abandoned and instead we have adopted the Modcam (Modcam, 2016), a device developed by a Swedish start-up that tracks occupancy patterns. The device has a built in camera and by analysing the pixel difference between frames, movement patterns emerge. Several notable advantages exist in using this technology as opposed to the previously mentioned ones:

- The devices work in unison. For bigger areas, multiple devices with some areas of overlap can be used and Modcam provides the process of combining the information from the different devices.
- Privacy is guaranteed. The image information is processed on the devices and only the anonymous information regarding the movement is being transmitted to the server. Furthermore, information is transferred to the server in 15 minute chunks, ensuring that instead of knowing where people are in every given second, we focus on larger scale trends. This is also beneficial in saving bandwidth as no images are being transferred to the server reducing the amount of data being sent to only several kB every 15 minutes.
- Setting up the system is very easy. The devices should be mounted below the ceiling or on a high point facing down, plugged in to an usb cable for electricity and configured to connect to the network's Wi-Fi. Data is being sent and stored to the servers of Modcam from which it can later be retrieved using an api.

For the pavilion we have used 11 modcam devices integrated seamlessly in the canopy and have been collecting data from May 2016 for a period of several months in 15-minute intervals. Both occupancy and thermal comfort information have been stored in databases for further analysis and post processing of the results. In addition a web application has been developed which offers a visual representation of the results and an interface to choose and move between different times.

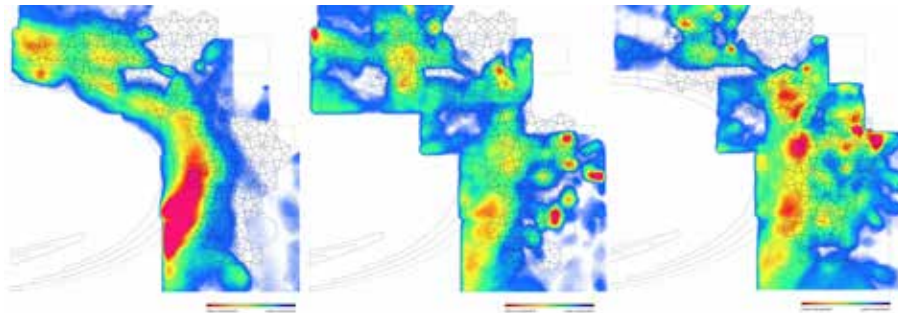

FIG. 4 Mobility frequency – example of three different frames

4 RESULTS

In the symbiotic relation between the built environment and people's flows in space, urban microclimatic conditions are confronted with the recorded data of people movements to evaluate their influence on human mobility. The relation between digital information and its physical manifestation is therefore linked with the environmental conditions obtained by simulations and measurements of microclimate in the selected area.

The relevant time interval for the analysis is related to the museum opening hours and, therefore, to people's presence in the courtyard where the pavilion is located. It results a useful timeframe from 10 am to 5:45 pm.

The data evaluation was carried out using two different methods: a tabular and a graphical method.

In the tabular analysis the single values composing the UTCI – solar radiation, air temperature, relative humidity and wind velocity – are confronted using day average resulting from the recorded data. The UTCI-Score, the equivalent temperature (ET), and the daily average movement frequency are included. This approach is intended to lead to a general objective overview for understanding the local dependencies and influences related to the single parameters and context of the Elytra filament pavilion and its environment.

Following, more detailed observation was done basing on the graphical observation. With the information gathered from the tabular evaluation the single frames of a specific day are defined. The graphical analysis allows a more detailed spatiotemporal distribution of information and through the more effective visual representation.

4.1 TABULAR EVALUATION

The following evaluation consists of two steps: first, the evaluation of local weather data and its influence on the UTCI-Score; second, the movement frequency is related to the UTCI-score. The data recordings used start from June 2016 and end in July 2016.

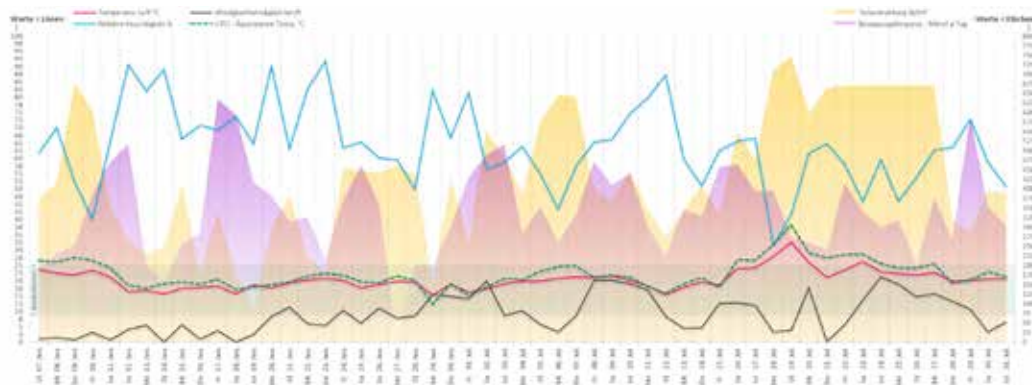

FIG. 5 Tabular evaluation – all factors

4.1.1 outdoor comfort

The climatic factors (solar radiation, air temperature, relative humidity and wind velocity) determine the level of the UTCI-Score and have relevant dependencies one to each other. The equivalent temperature is used as an indicator to determine comfort conditions and is correlated to the moving frequency.

4.1.2 movement frequency

Figure 4 generates an abstract overview of the moving behaviour of the museum visitors. It represents the frequency during the observation period (June 7th to July 31st 2016). The violet curve represents the movement intensity during opening hours basing on the modcam values. It corresponds to the average of all 15-min frames composing one day.

Low movement intensities are in a range of 100-150, regular frequencies around 300-400 and high frequencies are up to 600. These values have not a specific unit as the modcam technology measures movement frequency e.g. how much movement is recorded in each of the 10 by 10 cm pixel. This does not indicate the amount of people moving, but the moving intensity at a certain point. The represented data is therefore a sum of recorded movements.

Nevertheless, the data corresponds precisely to people's presence as it increases during museum opening hours and shows peaks during weekends or bank holidays, independently from the UTCI-Score. Also the different opening time on Fridays (10 am to 9:30 pm) is precisely represented.

The graphs shown in Fig.4 and 5 were used as temporal overview over the entire observation period. The results don't show any strong correlations between UTCI Score and moving frequency (Fig. 5), but they validate the assumption on the amount movement and – consequently – of people's presence. The graphical evaluation was used to carry out a more detailed analysis of the dependencies, in particular to determine more precisely stay time, paths and positions under the pavilion.



FIG. 6 tabular evaluation – UTCI and mobility frequency

4.2 GRAPHICAL EVALUATION

The graphical analysis bases on the observation, overlay and evaluation of the maps created and shown on the website (elytra-pavilion.com) as a visualization of the recorded data. A shadow analysis was done to integrate the existing data, as shadow - as we will see - strongly affects the results.

To filter the consistent amount of frames, six representative days were selected corresponding to the three following criteria:

- A high UTCI Score;
- An average UTCI Score;
- A low UTCI score.

The days correspond to a hot sunny day, a cloudy dry day and to a cold, rainy day. Due to this differentiation the frequency, the activity and the behaviour is evaluated relating to the UTCI score.

For each reference day a visualisation of all movement patterns was done indicating peaks in movement frequency that allows reading clear characteristics and tendencies. To each image a corresponding picture of the UTCI is associated.

4.2.1 Evaluation Reference Day 3 – cold/humid

Figure 6 visualizes the data for June 29th and July 1st as these two days have very similar climatic conditions. June 29th has an average UTCI-Score of 12,4°C-ET and July 1st 15,2°C-ET. Both days are far below the average value of 21,8°C-ET of the entire survey period and are in the range of „no thermal stress“ close to the „slight cold stress“ range. Air temperature and solar radiation show low values whereas relative humidity is higher than average. For those days the mobility patterns are quite similar, although the frequency is higher on the second day; on June 29th, a Wednesday, movement frequency is very low whereas July 1st, a Friday, shows higher movement frequency. What is clear for both days is that the concentration of movement is located around the pond, on the oval segment next to the pavilion. Beyond this, no particular points show stronger occupancy that could correspond to a longer stay. This phenomenon can be related to the fact most of people just pass by the pavilion to cross the courtyard. Due to the bad weather conditions, the structure has been used just as a rain protection while crossing the courtyard, in particular because people only used the stone path on the floor and avoided the open roof elements that don't provide any protection from rain. The main difference for both days is the amount of movement in the transit area.

The evaluation shows that in the UTCI range between 12-15°C-ET the pavilion does not contribute to any specific comfort characteristic as it protects partially from rain but does not provide any protection from wind and side rain.

In addition to that, the courtyard does not attract people during rainy cold days.

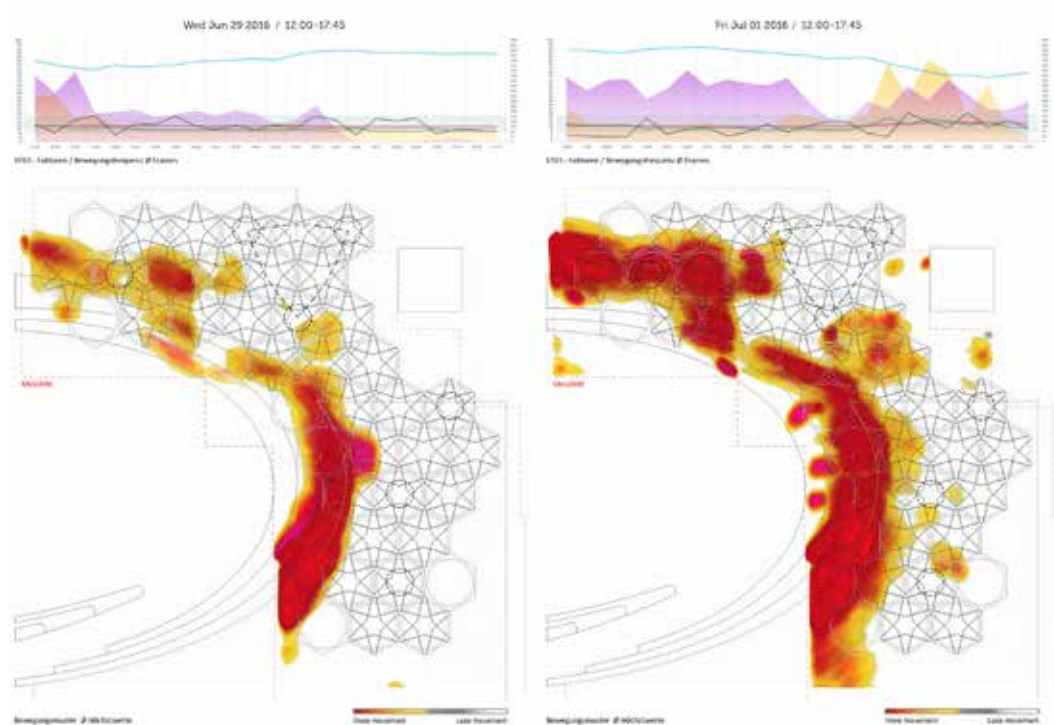

FIG. 7 graphical evaluation day 3

4.2.2 Evaluation Reference Day 1 – hot/sunny

Monday July 18th and Tuesday July 19th are the selected reference days for the first type.

They differ completely from type 3 as they have an average UTCI Score of respectively 31,8°C-ET and 38,4°C-ET. They are far above the average of 21,8°C-ET. July 18th is in a range between „strong heat stress“ and „very strong heat stress“, July 19th between „strong heat stress“ and „very strong heat stress“. The air temperature is 6 K below the UTCI ET, air humidity is low (32% and 42%) and solar radiation is in average 700 W/m² and 750W/m². Wind velocity is very low.

The movement frequencies are related to the same time interval for both days, whereas on Monday July 18th the value is higher than on Tuesday, which had been the hotter day. This phenomenon could be referred to the higher temperatures and to the consequent tendency of reducing movement due to the „very strong heat stress“. Figure 7 shows completely different patterns compared to type 3. There are no visible “paths”, instead clear places where the movement frequency is higher. This means that people tended to occupy specific places for longer intervals that coincide with the shadow areas of the pavilion. Extremely relevant information that arises is the fact that people prefer to stay on the lawns.

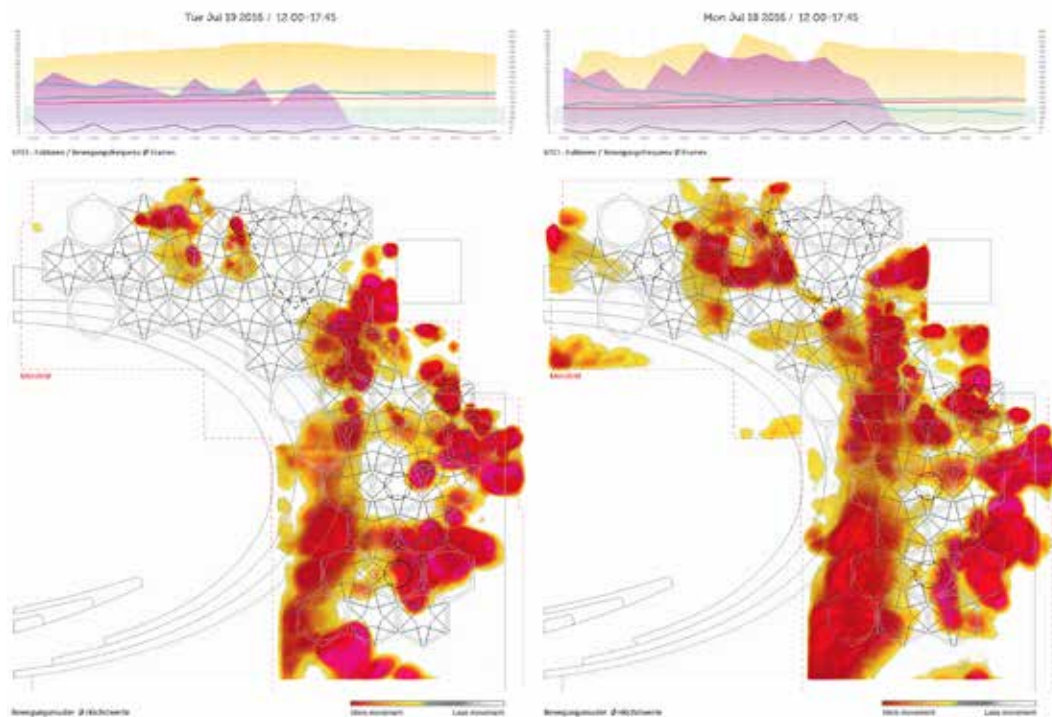

FIG. 8 graphical evaluation day 1

5 CONCLUSION

Combining the movement patterns with micro climate analysis is the primary aim of this research project. Furthermore, by looking at the intersection of people, place and technology this study provides answers to the original question: can microclimatic conditions shape behavior? To answer this it is crucial to regard both subjective and objective parameters. As thermal comfort in an outdoor environment is a complex issue with multiple layers of concern, at the present stage, our study is limited to an objective observation, excluding subjective factors.

Due to data availability, the survey is limited to the summer period, is referred only to museum visitors and was carried out on considering only a specific sector of the V&A Museum's courtyard: these constraints were given by the project itself.

The analysed data find its correlation in a model that overlays data on two different temporal scales and with two layers of concern: a wider scale that gives general information about weather condition and people's presence, and a more detailed scale that focuses on typical days with specific climatic conditions and visualizes movement in a higher resolution.

Looking to the larger scale, air temperature seems to be the most influencing factor for the level of UTCI; e.g. poor comfort conditions correspond to a reduced presence of people.

Shifting to a higher resolution, there is not a strong recognisable dependency between UTCI and mobility patterns. Comparing movement frequency to single climatic factors, such as solar radiation and humidity, the relation becomes more evident and they emerge as the most influencing factors.

Thinking of a development of the present project, a more detailed evaluation of the single factors could provide more appropriate information to detect dependencies.

In general, umidity seems to be a factor that strongly affects comfort: both as an indicator for rainy days, as well as a source of evaporative cooling during hot days. Also solar radiation is clearly determining peoples' presence – in sunny days it is consistently higher – because it influences the mobility patterns: during sunny hot days people rather choose shaded places and those close to vegetation. Both the lawn pavement sector as well as the areas around the trees show higher movement frequency.

As a result, it seems clear that canopies have to provide proper shade and rain protection and must allow enough wind flows during hot days. Furthermore, they should integrate devices (also plants or trees) that can provide evaporative cooling or more in general cooling effects and higher wind velocities. A determinant factor is represented by the pavement material, that should be considered as an element of the canopy as it influences Mrt and path finding.

Finally, considering the typology of the Elytra filament pavilion - an open structure in a museum courtyard - the results show a clear tendency: under good weather conditions, outdoor comfort acquires more relevance on mobility patterns.

Acknowledgements

The authors would like to express their deep gratitude to Thomas Auer for initiating this research project and for supporting it continuously. Furthermore we would like to thank Wolfgang Kessling from Transsolar Munich and Moritz Doerstelmann of the Institute for Computational Design at Stuttgart University, project manager of the Elytra Filament Pavilion, for their support.

References

- Chen, L., & Ng, E. (2012). Outdoor thermal comfort and outdoor activities: A review of research in the past decade. *Cities*, 29(2), 118-125.
- Gulyas, A., Unger, J., & Matzarakis, A. (2006). Assessment of the microclimatic and human comfort conditions in a complex urban environment: Modelling and measurements. *Building and Environment*, 41, 1713-1722.
- Höppe, P. (2002). Different aspects of assessing indoor and outdoor thermal comfort. *Energy and Buildings*, 34, 661-665.
- Kessling, W., Engelhardt, M., Kiehlmann, D. (2013) The Human Bio-Meteorological Chart - A design tool for outdoor thermal comfort, in PLEA 2013 Conference proceedings
- Modcam (2016-04-09). Retrieved 2016 from <http://modcam.io/>
- Reinhart, C. F. (2011), "Simulation-based Daylight Performance Predictions", Book chapter in *Building Performance Simulation for Design and Operation*, Editors J Hensen and R Lamberts, Taylor & Francis.
- Sadeghipour Roudsari, Mostapha, and Michelle Pak. „Ladybug: a parametric environmental plugin for grasshopper to help designers create an environmentally-conscious design." Proceedings of the 13th International IBPSA Conference. Lyon, France, 2013.

Updated urban facade design for quieter outdoor spaces*

Jochen Krimm^{1/2}, Holger Techen¹, Ulrich Knaack²

- 1 Frankfurt University of Applied Sciences, Department 1/Architecture-Civil Engineering- Geomatics, Nibelungenplatz 1, 60318 Frankfurt , tel. no.+496915333001, Holger.Techen@fb1.fra-uas.de
- 2 Delft University of Technology, Faculty of Architecture and The Build Environment, Architectural Engineering + Technology, Julianalaan 132-134, 2628 BL Delft, tel. no.+31 15 27 88566, U.Knaack@tudelft.nl

Abstract

The increasing migration into cities leads to an increasing number of people stressed by noise. More and more people are moving into urban settings comprised of multiple noise sources and hard reflective glass and steel facades. The omnidirectional arrangement of noise sources like airborne noise or car traffic noise and their reflection on the facades neither composes urban arrangements with silent indoor areas nor com-fortable quiet areas outdoor. To come up with requirements for silent areas inside and outside of buildings further design parameters have to be introduced. The facade is not only a shelter for the inside it can also provide comfort spaces outside the building. As engineers and archi-tects we cannot change the noise source, but we can influence the impact on the surrounding urban space by controlling the reflection of noise emissions on the urban surfaces like facades. In a facade design the capability of reflecting noise can be tuned by modifying the surface. In order to come up with the acoustical needs no radical new way of facade design has to be introduced. Mainly a shift of attention to the acous-tic parameters is needed. Based on acoustic measurements of basic geometry principles this research presents known facade designs and their acoustic parameters regarding the reflection capabilities and the functions in a facade.

Keywords

acoustics, soundscape, geometry, facades, design parameter, noise

- * Full paper published in JFDE / Journal of Façade Design and Engineering, Volume 5, Number 1, 2017.
DOI 10.7480/jfde.2017.1.1422

Optimised Parametric Model of a Modular Multifunctional Climate Adaptive Façade for Shopping Centres Retrofitting*

Riccardo Pinotti¹, Stefano Avesani², Annamaria Belleri³, Giuseppe De Michele⁴, Philip Ingenhoven⁵

- 1 UNIBZ Free University of Bolzano / EURAC Institute of Renewable Energy, 39100 Bolzano/Bozen – Italy, riccardo.pinotti@eurac.edu
- 2 EURAC Institute of Renewable Energy, 39100 Bolzano/Bozen – Italy, stefano.avesani@eurac.edu
- 3 EURAC Institute of Renewable Energy, 39100 Bolzano/Bozen – Italy, annamaria.belleri@eurac.edu
- 4 UNIBZ Free University of Bolzano / EURAC Institute of Renewable Energy, 39100 Bolzano/Bozen – Italy, giuseppe.demichele@eurac.edu
- 5 EURAC Institute of Renewable Energy, 39100 Bolzano/Bozen – Italy, philip.ingenhoven@eurac.edu

Abstract

A modular multifunctional façade for the retrofit of shopping malls, capable of adapting to different climates and to the existing building features both by the presence of movable components and by proper sizing of the fixed ones, is under development within the European FP7 project CommONEnergy. In particular, this curtain-wall façade is equipped with a fixed shading system, a photovoltaic panel with a battery feeding the automated openings for natural ventilation. The aim of this work is to define a reliable parametric model for a multi-functional façade system, to support designers with a set of useful data for the holistic design of the façade configuration depending on climate, orientation and building use. Firstly, a reference zone model for the façade was devised; this had to be both representative of reality and smartly defined for simulation software implementation. Besides the definition of the façade model parameters, all unknown design parameters were identified with their minimum and maximum values, depending on different possible applications and environmental conditions in which the façade could be applied. The inputs for the model were defined in a parametric matrix and included: facade module size, facade orientation, climate, window typology (thermal transmittance and g-value), distance between the shading lamellas, tilt angle, and openable window size. The simulation engine was decoupled: visual comfort and artificial lighting use were assessed with Radiance, while the façade thermal behaviour was evaluated by means of building energy simulations in TRNSYS, taking into consideration the daylight assessment results. For each simulated configuration, a set of relevant outputs fields for Indoor Air Quality, thermal and visual comfort, and energy performance were derived. The main considered performance indicators were the long-term percentage of people dissatisfied, the number of hours when CO₂ concentration was within the recommended values for each of the categories defined by EN 15251:2007, the illuminance provided by daylight, the energy consumption due to lighting, ventilation, heating and cooling, and the energy generated by the PV panel. Moreover, all outputs were collected in a pre-design support tool comprised of a database accessible through a filtering system to gather the desired performances. This work highlights the role of thermal and daylighting simulation in the design of an adaptive multifunctional façade through the definition of a methodology for the support at the pre-design phase.

Keywords

Façade, Multifunctional, Parameterization, CommONEnergy, TRNSYS

* Full paper published in JFDE / Journal of Façade Design and Engineering, Volume 5, Number 1, 2017.
DOI 10.7480/jfde.2017.1.1421

Field monitoring in Mediterranean climate to quantify thermal performances of vertical greening systems

Katia Perini¹, Francesca Bazzocchi²

- 1 Department of Architectural Sciences, University of Genoa , Stradone S. Agostino 37, 16123 Genova, Italy. Tel. +390105861
- 2 Ricerca Sistema Energetico RSE s.p.a., via Rubattino 54, 20134 Milano, Italy, Tel. +390239925013

Abstract

Green envelopes can provide environmental and ecological benefits in dense urban areas, improving air quality, mitigating Urban Heat Island effect, reducing energy use for air conditioning. The present study is based on field monitoring of the pilot project INPS Green Façade, built in Genoa (Italy) to quantify its environmental, economic, and social benefits. The vertical greening system was installed on the south wall of an office building built early in the last century and renovated in the 1980's, owned by INPS (National Institute of Social Insurance). The facade is exposed to solar radiation several hr/day in summer and 1–2 hr/day during winter. The external walls are constituted by two layers of masonry spaced by a 51 cm air gap (resulting from the retrofitting works), with a layer of 5 cm of insulating material. An experimental investigation allows evaluating the thermal performances of a well vegetated vertical greening system during summer and winter. This study demonstrates that a green layer can mitigate outdoor and surface temperatures, thus improve comfort conditions and reduce building surfaces warming up (contributing to urban heat island mitigation). The cooling capacity of vertical greening systems, with air temperature difference up to 10°C, can be exploited to reduce energy demand for air conditioning during summer. Although the energy saving for cooling strongly depends on several factors, the results obtained show a potential significant reduction of energy need for air cooling. The consequence of the vertical greening system on energy demand during winter is more complex to define because combined effects can be registered: prevention from solar radiation, shielding from the wind and a natural ventilation of the cavity.

Keywords

energy, vertical greening systems, building envelope, air conditioning, cooling, insulation

1 INTRODUCTION

A wide replication of green envelopes can be a good opportunity to improve the urban environment conditions. In fact, vertical greening systems and green roofs can provide environmental and ecological benefits in dense urban areas, improving air quality, mitigating Urban Heat Island effect, reducing stormwater runoff, etc. (Ardente et al., 2011; Ascione et al., 2013; Hashemi et al., 2015; Ottel  et al., 2010; Wong et al., 2010).

Vertical greening systems are made by simple climbing plants, supporting structures for their growth or planter boxes placed at several heights with a shading function; others provide the possibility to cultivate species naturally not suitable for growing on vertical surfaces, thanks to the disposition of pre-vegetated panels, defined as "living wall systems" (K hler, 2008).

Hunter et al. (2014) show that vertical greening systems (VGS) are increasingly being considered as a design feature to cool internal building temperatures, to reduce building energy consumption and to facilitate urban adaptation to a warming climate. VGS can have a positive influence on the building envelope performances in terms of thermal performances especially in the cooling periods, as demonstrated by several studies (P rez et al., 2014). The cooling capacity of VGS is related to plants evapotranspiration and shading effect (Krusche et al., 1982; Safikhani et al., 2014). Cooling is achieved because the leaves receive the solar radiation on the fa ade (also as a result of phototropism; Bellomo, 2003) protecting the wall behind. A green layer reduces the temperature of the hot summer by the evaporating water from the surface of the foliage (Wong et al., 2010).

Eumorfopoulou & Kontoleon (2009) showed a potential reduction of up to 10.8 °C in the surface temperature of a fa ade greened in the Mediterranean area. Hoelscher et al. (2015) compared greened (with climbing plants) and bare walls showing surface temperatures of the greened exterior walls up to 15.5 °C lower than those of the bare walls, while it was up to 1.7 °C for the interior wall. Vertical greening systems insulation value can be optimized by covering with high density foliage, creating a stagnant air layer behind the foliage (Perini et al., 2011), exploiting supporting system materials and their insulation effect and plant species characteristics (Cameron et al., 2014).

Studies show a potential energy saving for air conditioning that can be obtained with vertical greening systems up to 40-60% in Mediterranean area (Coma et al., 2014; Mazzali et al., 2012; Safikhani et al., 2014). However indoor temperature reduction due to a green layer is highly influenced by the building envelope layers: according to Ottel  (2011) insulation material moderates the prevailing temperature's difference between the outside and inside, as it is possible to conclude according to the results obtained by Mazzali et al. (2012).

Several researches were conducted to determine the effectiveness of vertical greenery systems and their influence on thermal transfer value, energy consumption, cooling effect, temperature variation (Safikhani et al., 2014). Studies demonstrate that vertical greening systems can reduce the energy demand for air conditioning by reducing indoor temperatures, although not focusing on other possible ways to fully exploit the cooling capacities of vegetation.

The aim of this research was to determine the performance of vertical greening systems in the Mediterranean climate of Italy, analyzing a pilot project built in the city of Genoa. The authors performed an experimental investigation to evaluate the performances of a well vegetated vertical greening system during summer and winter.

2 METHODOLOGY

The present study is based on field monitoring of the pilot project INPS Green Façade. The vertical greening system was installed during the months of October and November 2014 on the south wall of an office building built early in the last century and renovated in the 1980's, owned by INPS (National Institute of Social Insurance) and located in the city center of the Genoa neighborhood of Sestri Ponente. The facade is exposed to solar radiation several hr/day in summer and 1–2 hr/day during winter.

The building has a net area of 2427 m², divided in 4 floors, and a volume of 7181 m³. The external walls are constituted by two layers of masonry spaced by an air gap of variable thickness (from 26 cm to 51 cm depending on the facade, 51 cm in correspondence of the south façade, as result of retrofitting works done in the 80s). A layer of 5 cm of insulating material (polystyrene) is placed between the air cavity and the external layer of masonry. The global transmittance value of the external walls is 0.44 W/m²K.

INPS Green Façade was built as pilot project to quantify the positive effects of green envelopes in densely built urban environments, particularly their role in improving environmental conditions and reducing ecological imbalances. The vertical greening systems (VGS) chosen is a living wall system made of a mat planted with different plant species (e.g., climbing plants, shrubs, evergreens). It consists of panels (mats) composed of two layers of special geotextile. The system is irrigated with a drip line in each module. The system is irrigated with about 2.5 l/m² day, delivered in several hours during night, in the summer, while it was irrigated with about 1.8 l/m² day during fall. 20 different plant species are integrated, both climbing plants and shrubs.



FIG. 1 INPS Green Façade (photo by Anna Positano)

INPS Green Façade pilot project aims to quantify the positive effects of the green envelopes in densely built urban environment to improve environmental conditions and reduce ecological imbalances caused by artificial versus natural surfaces. Monitoring activities are focused on the evaluation of the environmental benefits, both economic and social, in particular in densely urbanised areas, with special attention to the Mediterranean area.

This paper presents the results of the summer and winter monitoring campaign focused on the benefits of the vertical greening system on indoor comfort and on energy performance of the building. The main quantities analysed are: external surface temperatures in presence and in absence of the vertical greening system; solar radiation, outdoor air temperature and humidity are also monitored. The plant species near and around the monitoring area are *Cistus Jessami* beauty and *Cistus crispus*.

The monitoring campaign, presented in this paper, was performed during summer 2015, from the 1st May 2015 to the 30th September 2015, in order to describe the entire summer period, and during winter from the 1st October 2015 to the 4th February 2016. During summer period the maximum measured hourly average outdoor air temperature was 40.9°C, the minimum measured hourly average temperature was 12.9°C and the average temperature was 24.3°C. During winter period the maximum measured hourly average outdoor air temperature was 27°C, the minimum measured hourly average temperature was 3.5°C and the average temperature was 14.2°C.

Two 8 cm diameter ducts were made throughout the building wall connecting internal surface with external surface (Figure 3). The ducts were provided with impellers (Axial fan a.c. 80x80x25mm, max air flow 41 m³h⁻¹), in order to extract air from outside and supplied it to the rooms. One of the ducts is located in correspondence of the vertical greening system, so the air extracted comes from the gap between the vertical greening system and the external wall; the other duct is not influenced by the vertical greening system, so the air extracted is undisturbed external air. A resistance temperature detector was placed in each of the ducts in order to monitor the air temperature circulating inside. Therefore, the measured temperature represents, in the first case the temperature of the air sheltered from solar radiation by the vertical greening system and cooled by the vegetation effect, in the second case the measured temperature is equivalent to undisturbed external air one. By means of these ducts, the cooling capacities of vertical greening systems can be evaluated by comparing a green and non-green situation without the influence of internal conditions.

Figure 3 describes the measured quantities and the placement of measuring instrument. All the quantities monitored are reported in Table I. Data are acquired every minute and hourly average values are recorded.



FIG. 2 Outdoor monitoring system after the installation of the vertical greening system

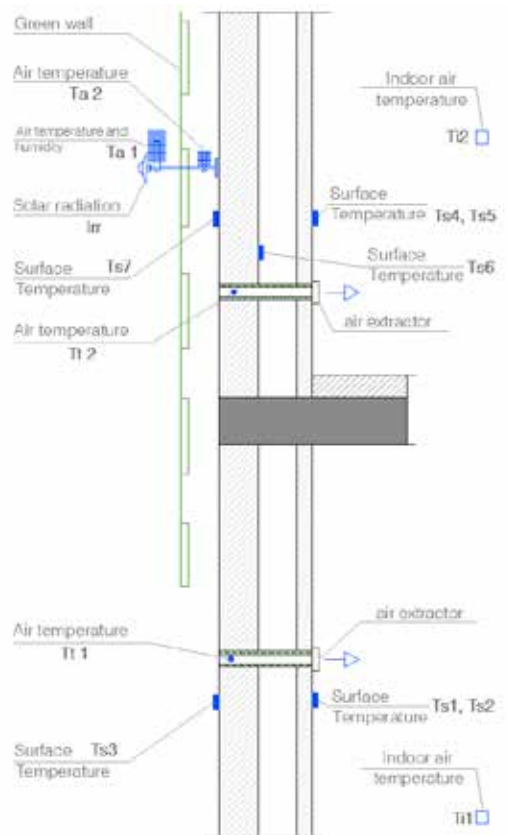

FIG. 3 Monitoring system

QUANTITY	NOMENCLATURE	TYPE	UNCERTAINTIES
Outdoor relative air humidity	UR	Humidity transmitter	$\pm 1\%$ r.h.
Solar radiation	Irr	Global Solar Radiation Transducer	± 10 W/m ²
Outdoor air temperature	Ta1	RTD Pt100 (Class A)	$\pm 0.15^\circ\text{C}$ (at 0°C)
Air temperature in the gap between the vertical greening system and the building's wall	Ta2		
Indoor air temperature, in a room effected by the vertical greening system	Ti2		
Indoor air temperature, in a room not effected by the vertical greening system	Ti1		
Inside surface temperature in a room effected by the vertical greening system	Ts4, Ts5		
Surface inside temperature between the external wall and the air gap	Ts6		
Inside surface temperature in a room not effected by the vertical greening system	Ts1, Ts2		
Outside surface temperature of a room effected by the vertical greening system	Ts7		
Outside surface temperature of a room not effected by the vertical greening system	Ts3		
Extracted air temperature from behind vertical greening system	Tt1		
Extracted air temperature from outside	Tt2		

TABLE 1 Recorded quantities and related nomenclatures, measuring instruments and uncertainties

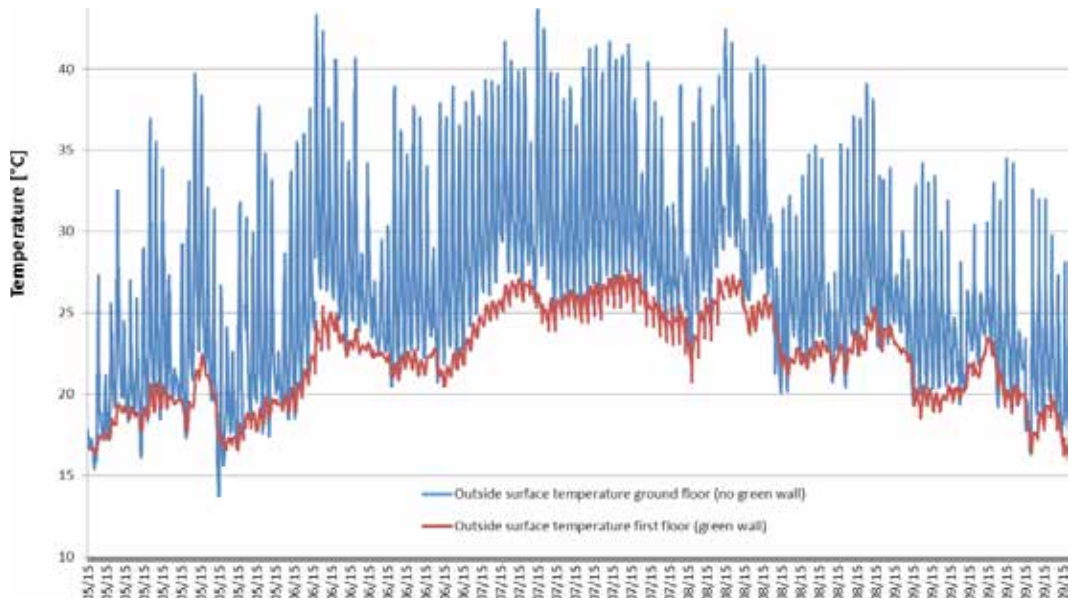

FIG. 4 Comparison between external surface temperatures in presence and in absence of the vertical greening system – summer monitoring

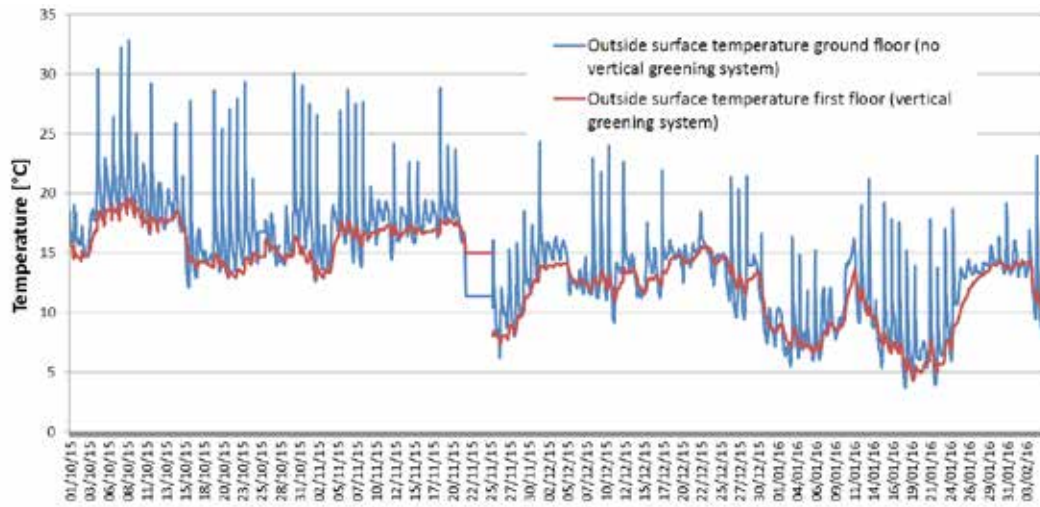

FIG. 5 Comparison between external surface temperatures in presence and in absence of the vertical greening system – winter monitoring

3 RESULTS AND DISCUSSION

Vertical greening systems, preventing the solar radiation from reaching the wall, affect surface temperatures, as shown in Figure 4 and 5, where a comparison between external surface temperatures in presence and in absence of the vertical greening system is presented. Summer data shows that the surface temperature in presence of the vegetation is up to 20°C lower than in the case with no green wall, during the hottest hours of the day. During the night, instead, the difference between two temperatures is 2°C maximum, depending on external conditions

Surface temperatures during winter are shown in Figure 5. The effect is the same of the summer period: the vertical greening system prevents the solar radiation from reaching the wall. In addition it can be noticed a smaller temperature reduction during night in presence of the vertical greening system. This can be due to the vegetation shielding effect from the wind.

Makeup air is an essential element for indoor air quality, particularly in structures that are well insulated and tightly built. The introduction of fresh air from the exterior provides the makeup air to replace air being exhausted. As a result, indoor relative humidity levels are kept at acceptable levels and a healthy atmosphere is assured.

Makeup air can be provided by the centralized conditioning air system, or by devices placed in each room that allow a constant amount of fresh air to enter (an example in Figure 6). During summer, the fresh makeup air is taken from outside and has to be cooled in order to reach the indoor air temperature without creating any thermal discomfort. As consequence, the extracted air temperature strongly influences the energy demand necessary for air conditioning.



FIG. 6 Example of a fresh air inlet device

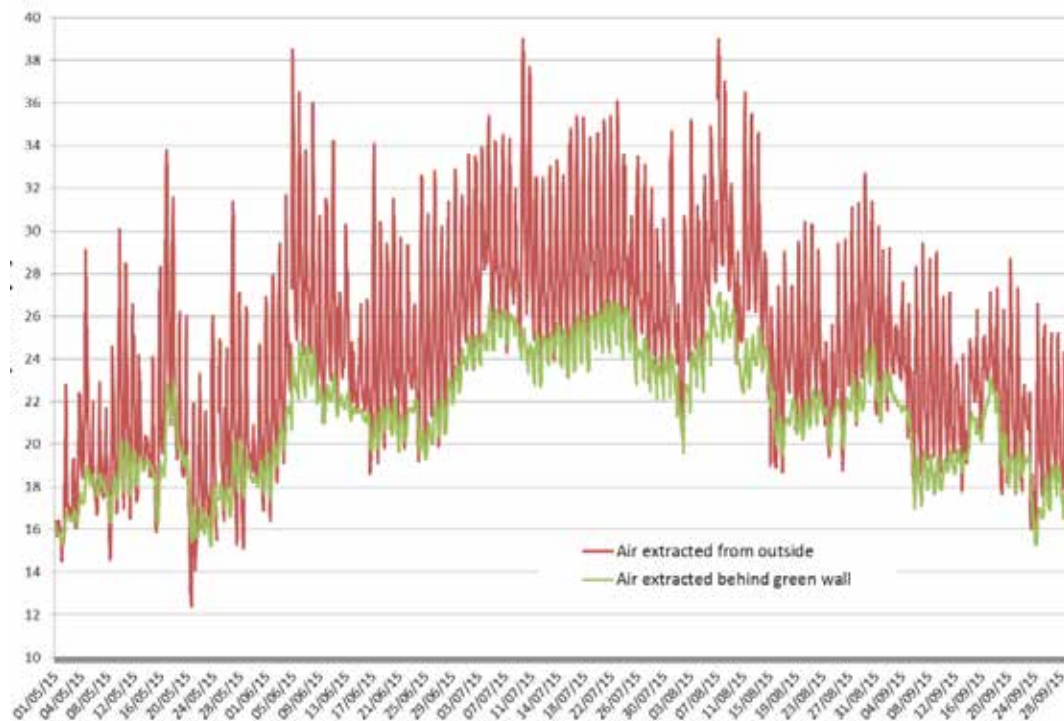

FIG. 7 Comparison between the temperatures of the outside extracted air in presence or in absence of the vertical greening system during summer period

Temperature of the air extracted from the two small ducts made throughout the building wall is analysed. The temperature difference between the air extracted behind the vertical greening system and the air extracted from outside allows to evaluate the advantage in using fresh air influenced by the vertical vegetation. By means of a fresh air inlet device (Figure 6), the cooler air extracted behind the vertical greening system can be exploited for makeup air.

The air is extracted through a frame fan with 80 mm diameter and an air flow rate of 41 m³/h.

In Figure 7 the comparison between the summer temperatures of the outside extracted air in presence or in absence of the vertical greening system is reported. The difference of these two temperatures can reach 10°C during the hottest periods.

Considering that the building analysed is an office building, only the period of the day corresponding to the common office building occupancy hours has to be taken into account, because makeup air is necessary only when rooms are used. Typical occupancy hours are deduced from Italian standard UNI/TS 11300-1, that indicates a typical time from 7 A.M to 5 P.M. This time interval has been extended from 8 A.M. to 6 P.M. because the building in exam is a public office building.

In Table monthly average extracted air temperatures calculated from hourly data from 8 AM to 6 PM are presented. In the period from June to August temperature of the air extracted behind the vertical greening system is on average 5°C cooler than outdoor air. The temperature difference is 3.2°C and 3.8°C in May and September.

Table also shows the monthly number of office hours (from 8 A.M. to 6 P.M.) that the air, both extracted from outside or behind vertical greening system, exceeds 26°C. This temperature represents the indoor temperature used for calculating the energy need for space cooling in Italian standard UNI/TS 11300-1. It can be noticed the difference between the two cases. Air extracted behind vertical greening system exceeds 26°C only in 25 hours in the month of July and in 8 hours in August.

Month	Air extracted from outside	Air extracted behind vertical greening system	Number of hours that air, extracted from outside, temperature exceeds 26°C	Number of hours in which air, extracted behind vertical greening system, temperature exceeds 26°C
	[°C]	[°C]		
May	21.0	17.8	43	0
June	26.5	21.3	171	0
July	29.8	24.6	287	25
August	27.3	22.7	196	8
September	23.0	19.2	54	0

TABLE 2 Monthly average temperature, calculated during office hours (from 8 AM to 6 PM), of air extracted from the two ducts, in correspondence of the vertical greening system

Results show that the use, during summer, of the air extracted behind vertical greening system, instead of outdoor air, for makeup air, allows introducing in the room air at lower temperature. This temperature difference can reduce the room thermal energy need for air conditioning, thanks to the decrease of room thermal load. The amount of energy saved during cooling mode strongly depends on several factors: the set-point temperature in the room, the air flow necessary for makeup air, dimensions and numbers of the ducts used for air extraction, the type of air conditioning devices and the relevance of internal gains. For these reasons additional research is needed to quantify the amount of energy that can be saved in cooling mode thanks to the presence of a vertical greening system.

4 CONCLUSIONS

The presented research quantifies the performance of vertical greening systems in the Mediterranean climate of Italy. The experimental investigation includes field measurements of the INPS Green Façade pilot project to evaluate the cooling potential of a well vegetated vertical greening system during summer.

This study demonstrates that a green layer can mitigate outdoor and surface temperatures, thus improving thermal comfort and reducing building surfaces warming up (urban heat island mitigation).

During summer, the temperature difference up to 10° C between the air extracted behind the vertical greening system and the air extracted from outside demonstrates the advantage in using fresh air influenced by the vertical vegetation. Interesting results can be noticed also looking at the monthly average difference (5°C) of the extracted air temperatures, calculated from hourly (8 AM to 6 PM) from June to August.

Although the energy saving for cooling strongly depends on several factors, the results obtained show a potential significant reduction of energy need for air conditioning, with only 25 hours exceeding 26°C in the month of July, 8 hours in August, and 0 in June, considering the air extracted behind vertical greening system. Differently the cooling hours (air temperature >26°C) without vegetation calculated are 171 for June, 287 for July and 196 for August.

Additional researches will allow demonstrating and quantifying the amount of energy saving for air conditioning considering the many factors involved. This study demonstrates that vertical greening systems cooling performances can be efficiently exploited to reduce energy demand for air conditioning, also considering the capacity of leaves in collecting fine dusts, resulting in air quality improvement.

Acknowledgements

This work has been financed by the Research Fund for the Italian Electrical System under the Contract Agreement between RSE S.p.A. and the Ministry of Economic Development – General Directorate for Nuclear Energy, Renewable Energy and Energy Efficiency stipulated on July 29, 2009 in compliance with the Decree of March 19, 2009. This research is part of the monitoring activity carried out to quantify environmental and energy performances of vertical greening systems funded by INPS (National Institute of Social Insurance) Liguria. U. Valle (INPS Liguria) is thanked for his important support.

References

- Ardente, F., Beccali, M., Cellura, M., Mistretta, M., 2011. Energy and environmental benefits in public buildings as a result of retrofit actions. *Renew. Sustain. Energy Rev.* 15, 460–470. doi:10.1016/j.rser.2010.09.022
- Ascione, F., Bianco, N., de' Rossi, F., Turni, G., Vanoli, G.P., 2013. Green roofs in European climates. Are effective solutions for the energy savings in air-conditioning? *Appl. Energy* 104, 845–859. doi:10.1016/j.apenergy.2012.11.068
- Bellomo, A., 2003. *Pareti verdi : linee guida alla progettazione* / Antonella Bellomo. Esselibri, Napoli.
- Cameron, R.W.F., Taylor, J.E., Emmett, M.R., 2014. What's "cool" in the world of green façades? How plant choice influences the cooling properties of green walls. *Build. Environ.* 73, 198–207. doi:10.1016/j.buildenv.2013.12.005
- Coma, J., Pérez, G., Solé, C., Castell, A., Cabeza, L.F., 2014. New Green Facades as Passive Systems for Energy Savings on Buildings. *Energy Procedia*, 2013 ISES Solar World Congress 57, 1851–1859. doi:10.1016/j.egypro.2014.10.049
- Eumorfopoulou, E.A., Kontoleon, K.J., 2009. Experimental approach to the contribution of plant-covered walls to the thermal behaviour of building envelopes. *Build. Environ.* 44, 1024–1038. doi:10.1016/j.buildenv.2008.07.004
- Hashemi, S.S.G., Mahmud, H.B., Ashraf, M.A., 2015. Performance of green roofs with respect to water quality and reduction of energy consumption in tropics: A review. *Renew. Sustain. Energy Rev.* 52, 669–679. doi:10.1016/j.rser.2015.07.163
- Hoelscher, M.-T., Nehls, T., Jänicke, B., Wessolek, G., 2015. Quantifying cooling effects of facade greening: Shading, transpiration and insulation. *Energy Build.* doi:10.1016/j.enbuild.2015.06.047
- Hunter, A.M., Williams, N.S.G., Rayner, J.P., Aye, L., Hes, D., Livesley, S.J., 2014. Quantifying the thermal performance of green façades: A critical review. *Ecol. Eng.* 63, 102–113. doi:10.1016/j.ecoleng.2013.12.021
- Köhler, M., 2008. Green facades—a view back and some visions. *Urban Ecosyst.* 11, 423–436. doi:10.1007/s11252-008-0063-x
- Krusche, P., Krusche, M., Althaus, D., Gabriel, I., 1982. *Ökologisches Bauen*, Umweltbundesamt. ed. Vieweg Friedr. + Sohn Ver., Deutschland.
- Mazzali, U., Peron, F., Scarpa, M., 2012. Thermo-physical performances of living walls via field measurements and numerical analysis. pp. 251–259. doi:10.2495/ARC120231
- Ottelé, M., 2011. *The Green Building Envelope*. Delft University of Technology, The Netherlands.
- Ottelé, M., van Bohemen, H.D., Fraaij, A.L.A., 2010. Quantifying the deposition of particulate matter on climber vegetation on living walls. *Ecol. Eng.* 36, 154–162. doi:10.1016/j.ecoleng.2009.02.007
- Pérez, G., Coma, J., Martorell, I., Cabeza, L.F., 2014. Vertical Greenery Systems (VGS) for energy saving in buildings: A review. *Renew. Sustain. Energy Rev.* 39, 139–165. doi:10.1016/j.rser.2014.07.055
- Perini, K., Ottelé, M., Fraaij, A.L.A., Haas, E.M., Raiteri, R., 2011. Vertical greening systems and the effect on air flow and temperature on the building envelope. *Build. Environ.* 46, 2287–2294. doi:10.1016/j.buildenv.2011.05.009
- Safikhani, T., Abdullah, A.M., Ossen, D.R., Baharvand, M., 2014. A review of energy characteristic of vertical greenery systems. *Renew. Sustain. Energy Rev.* 40, 450–462. doi:10.1016/j.rser.2014.07.166
- Wong, N.H., Kwang Tan, A.Y., Chen, Y., Sekar, K., Tan, P.Y., Chan, D., Chiang, K., Wong, N.C., 2010. Thermal evaluation of vertical greenery systems for building walls. *Build. Environ.* 45, 663–672. doi:10.1016/j.buildenv.2009.08.005

Benefit E2 – Building integrated solar active strategies

Christoph Kuhn¹, Steffen Wurzbacher², Christoph Drebes³

¹ Fachgebiet Entwerfen und Nachhaltiges Bauen, Prof. Christoph Kuhn, Technische Universität Darmstadt (ENB)

² Fachgebiet Immobilienwirtschaft und Baubetriebswirtschaftslehre, Prof. Dr. Andreas Pfnür, Technische Universität Darmstadt (bwl)

³ Goldbeck New Technologies GmbH (GB)

* Project team: Prof. Christoph Kuhn (ENB) , Prof. Dr. Andreas Pfnür (bwl), Steffen Wurzbacher (ENB), Christoph Drebes (ENB), Angeliki Metaxa (GB), Dr. Nikolas Müller (bwl), Lukas Romanowski (GB), Carolin Simon (ENB), Marius Riepe (ENB), Gabriela Atanasova (ENB), Robert Blessing (ENB), Jana Weber (ENB)

* Contact:

Steffen Wurzbacher, Fachgebiet Entwerfen und Nachhaltiges Bauen, Technische Universität Darmstadt, El-Lissitzky-Str. 1, 64287 Darmstadt, tel: +49 6151 / 16-22952, Mail: wurzbacher@enb.tu-darmstadt.de

Christoph Drebes, Fachgebiet Entwerfen und Nachhaltiges Bauen, Technische Universität Darmstadt, El-Lissitzky-Str. 1, 64287 Darmstadt, tel: +49 6151 / 16-22952, Mail: drebes@enb.tu-darmstadt.de

Abstract

The research project “benefit E2” builds on results of the previous social study “benefit E”, which analyzed barriers in the integration of solar active systems into the building skins. Main results of the first project described a lack of flexibility in design, material and construction as well as a lack of experience and acceptance of various planning participants. As solutions to lower identified barriers the following project “benefit E2” analyzes potential fields of actions and strategies to widen the variety of design tasks with integrated solar systems. The structure of the current project contains following work packages: In a first step possible fields of action in the German building stock are determined using typology based solar studies. Following this typical existing wall and roof build-ups are analyzed regarding their creative, constructive, energetic and economic ability for integration. In the end a comprehensive catalogue of measures will be developed describing the integration diversity depending on building typology, construction and design. Furthermore it is targeted to plan and realize a prototype for an office façade system in cooperation with the third-party funder Goldbeck New Technologies GmbH. In consideration of the preassigned energetic, constructive and economic general conditions an overall design solution should be achieved.

Keywords

solar energy, solar active systems, building integration, design strategies, hybrid systems, collector and photovoltaic

1 SOLAR ACTIVE BUILDING ENVELOPES (INTRODUCTION)

The building stock and newly built houses are a challenge and a potential at the same time. On one hand the energetic development of the building stock plays a key role within the energy revolution. On the other hand requirements for newly built houses are tightened successively. The EU Directive 2010/31/EU on the overall energy efficiency of buildings is launching an European standard called “nearly zero energy building” effective January, 1st 2019 for public buildings respectively for all other buildings by December, 31st 2020. It defines that “the nearly zero or very low amount of energy required should be covered to a very significant extent by energy from renewable sources, including energy from renewable sources produced on-site or nearby” (EU 2010). Following this rule the use of solar energy becomes obligatory for most of the construction. Besides a reduction of the energy requirements this as well implies an active use of regenerative energy generation.

In this context façades and in particular roofs offer great potential which has not been explored adequately so far. Though the development of solar heat and photovoltaic was increased by state funding, the use of solar active systems remains additive and is not yet recognized as part of the architecture itself. Most of the time these systems are realized as modules added to the components constructively without adopting structural physical functions. Up till now the creative integration of solar active systems as part of the architectural planning and execution happened only in particular cases. The practice of additive integration of solar active systems led to resistance and rejection by clients, planners and crafts in the past.

Furthermore the task of component integrative and architectural involvement of solar energy generation is facing additional concrete barriers. These have been elaborated and categorized in the course of the research project “benefit E” by Hegger, Drebes, and Wurzbacher (2015) based on qualitative interviews with decision-makers. Regarding the creative integration of solar active systems, the insufficient flexibility and variation in size were identified as the most relevant barriers. In this context the appearance of existing systems was described as too technical and particularly the further development of the design of solar active systems has been put in a claim. In addition complex constructive, judicial and economic obstructions could be identified affecting the use of solar systems within the building sector adversely. Besides the above mentioned design requirements, further solutions for these barriers have to be developed fostering the integrative use of solar active systems in terms of the energy revolution and the EU Directive.

The present paper describes planned methods to lower above mentioned barriers in order to an architectural integration of solar systems into the building skin. The project itself is promoted by the Forschungsinitiative Zukunft Bau, Bundesministerium für Umwelt, Naturschutz, Bau und Reaktorsicherheit (Code: F20-14-1-038 - 10.08.18.7-15.57) and Goldbeck New Technologies GmbH as third-party donor. The project “benefit E2” will be completed until September 2017.

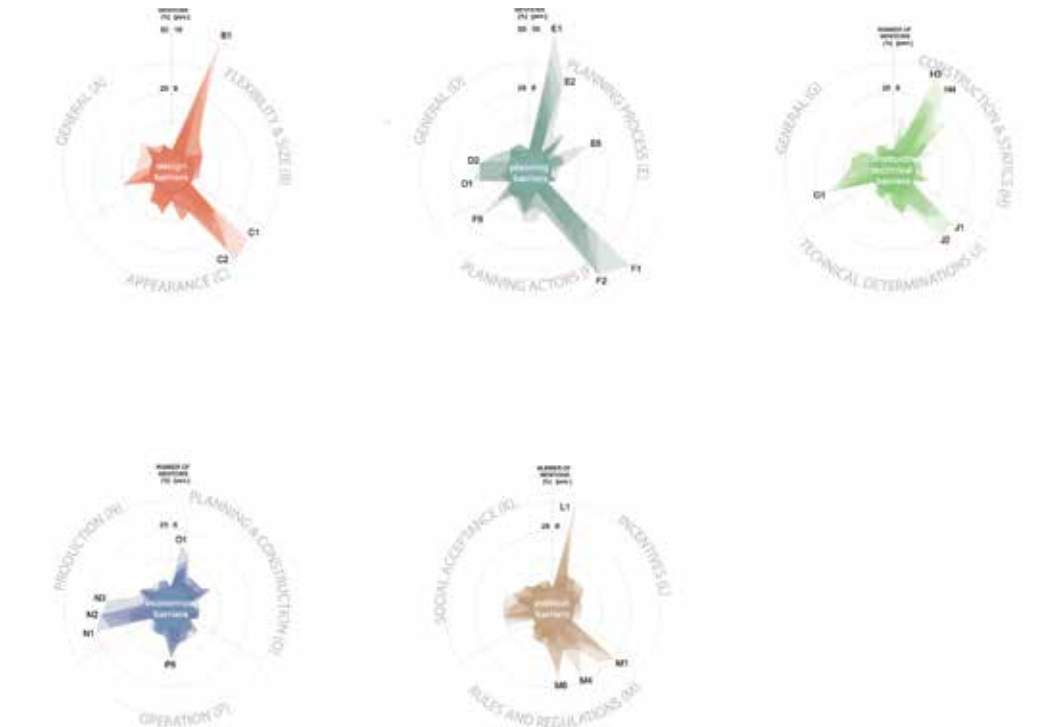

FIG. 1 Barriers according to categories (design, planning, constructive technical, economic, political), source: (ebd. 2015)

Theses

In the long term a successful and socially accepted implementation of the energy revolution within the building sector can only be realized with architecturally integrated solutions. It will be crucial to remove existing barriers (vgl. ebd. 2015) by increasing the variety of design for new products, improving the information flow and including the concept of solar energy systems into the planning process.

The technical systems used so far have to be adapted in favor of architectural and project-specific solutions. The possibility to adopt other structural-physical and constructive functions will be essential. At the same time a concomitant substitution of layers of building elements by solar activation has the potential of cost savings and an improved economy. Instead of general state funding according to the principle of “equal shares for all” (e.g. promotion without checking the output or the energetic suitability) dedicated fields of application according to building types and their components have to be identified which are suitable from an energetic, constructive and architectural culture perspective. It is assumed that different typologies come along with diverse abilities concerning the integration of solar active systems.

Previous concepts as „nearly zero energy“, “zero energy” or “plus energy” often use only a simple annual balance and the resulting annual yield to evaluate the efficiency of power based solar systems. Occasionally this led to an adaption of the cubage and building geometry in favor of big solar activated roof surfaces facing the south. But studies have shown that though maximizing the annual yield the orientation towards south does not automatically result in an increase of self-sufficiency. In order to improve self-efficiency a more equal distribution towards every direction is useful. In this context volatile effects of solar energy have to be taken into account more structurally and specifically to improve self-sufficiency respectively to relief the network significantly.

Goals

Main goal of the research project "benefit E2" is the development of strategies to increase the design variety of integrated solar active systems characterized by holistic architectural integration into a building concept.

A first target is the identification of fields of action and space potentials for a solar active use within the German building stock. Therefore an overview of the proportions of façade and roof surfaces and their specific solar potential within the overall building stock is necessary. Based on this leverage factors for an effective solar activation of the envelope can be derived.

The second target is to describe integration characteristics of the solar active use in typical building components of the envelope (façade and roof). For this purpose energy flows within the envelopes' building components will be monitored and valued.

A third target is dealing with the conception and establishment of a prototypical mock-up which should function as an example for a creative, constructive and technical integration of solar active devices.

2 METHOD

The survey of the theses outlined above will be based on three self-contained components, building up on each other:

- Typological potential studies
- Component-specific potential studies
- Realization of a prototypical pilot application

The three named components will be performed and documented in an own study design each.

2.1 SOLAR RADIATION POTENTIAL STUDY - TYPE BUILDINGS

To identify possible leverage factors of solar activation of envelopes as part of the heterogeneous building stock a detailed potential study will be performed. Structural characteristics and solar potentials will be identified and documented in a typology catalogue. In this document all necessary information and energetic parameters of each construction will be collected. The catalogue shall provide information about the specific solar potentials. Beyond this the survey will explore the amount and absolute surface and radiation potential of each envelope in Germany. This quantification is a prerequisite for the definition of key activities.

Building Types

The German building stock is subdivided into typical construction forms. This typing serves the evaluation of surface and solar potential as mentioned above following simple and visually detectable characteristics. Therefore an own classification of typical structural types will be established closely following previous studies in literature. Depending on the purpose, different approaches can be found.

Overall two groups of typing can be identified: One on the basis of user-specific and cultural aspects such as Roth (1980), Everding (2007) or Hegger et al. (2012) and a more form and geometry based view such as Deilmann, Bickenbach, and Pfeiffer (1977) as well as Vallentin (2011). The present research project orients itself on the second group, defining the following basic structures:

- Point type
- Block type
- Row type
- Hall type

Simulation and solar “fingerprint”

Own research (vgl. Hegger et al., 2012) will be used in order to determine structural characteristics of the defined building types. Furthermore representative and real development situations will be modelled in 3D and their specific geometry data will be extracted. In a second step irradiation simulations will be performed using Rhinoceros (3D-modelling), Grasshopper (automation) and Autodesk Ecotect (simulation). Evaluation will be realized by a specially developed excel model.

An important tool to compare solar potentials is the solar “fingerprint”, describing in a simple and precise way to which amount and on which part of the envelope solar radiation is existing. With the developed diagrams fast comparisons between the different building types are possible and the expectable irradiation potential can be quantified.

The solar „fingerprint” is built up as a simple xy-diagram. On the y-axis the degree of solar exposition of each of a particular partial surface can be found. A 100% solar exposition means that at the particular location this partial surface is exposed to the same amount of radiation as a non-shaded horizontal surface. A solar exposition of 50% means that only half of the possible solar radiation compared to a non shaded horizontal surface can be found on the chosen partial surface.

With the solar „fingerprint” simple and quantifiable statements can be made concerning height and position of potential solar radiation yield. As shown in Fig. 2 different types exhibit different solar potentials. While the envelope of hall types show 60% of solar exposed surfaces, block types show 25% only. Based on these values simple and precise calculations of possible energy or heat gains from solar radiation can be balanced for further strategic planings.

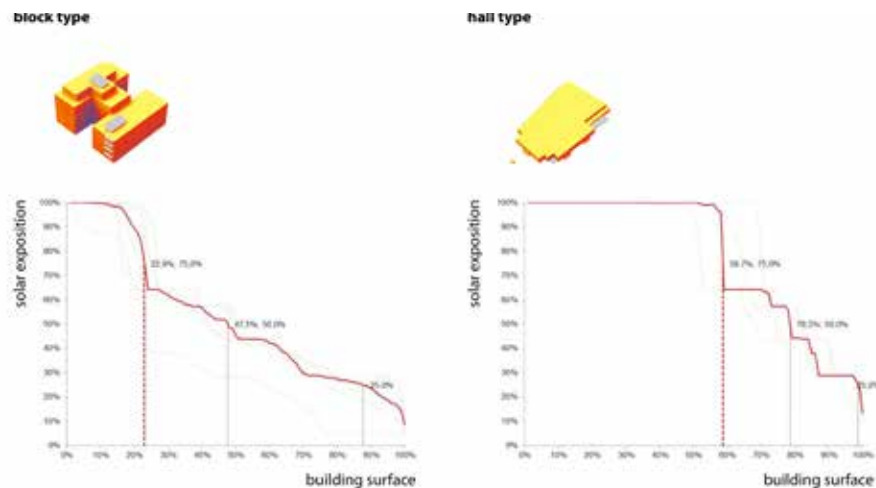

FIG. 2 solar “fingerprint” block type (left) and hall type (right)

Typology Profile

The conducted analysis concerning structural and energetic parameters will be bundled and summarized in typology profiles. Determined statements about the distribution of radiation and reduction factors (self- and external opacity, opacity through subordinate components etc.) will be made. An overall evaluation describes the energetic, technical, constructive and economic potentials of the envelopes for each building type. The typology profiles are designed as a simple reference in order to estimate the potential in a quick and easy way.

2.2 DESIGN RELATED ENERGY STUDY - BUILDING COMPONENTS

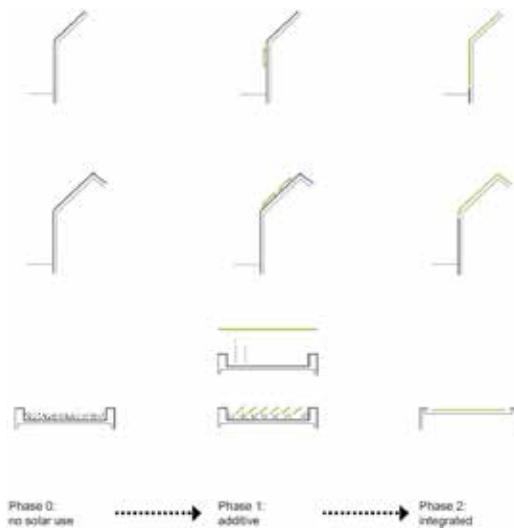

FIG. 3 Basic principle of the building integration

In a further step possibilities to increase the design variety of solar systems in the building envelope will be identified taking into account energetic, constructive, creative and economic aspects. In the course of the studies on the typology catalogue focused scopes are localized within the building envelope which can be expected to have a potentially high solar yield and which are of interest for a sustainable energy generation. Fields of integration and scopes will be derivable from determining specific situations of radiation. Typical design and construction principals of façade and roof surfaces are analyzed depending on the present building type and the average expectable building class. On this basis the sensitivity of intervention can be evaluated. This provides information about possible fields of solar active use for reasons of building culture and design.

While discussing relevant forms of energy for the usage of the building the project team set itself the task to explore hybrid applications. The combination of sustainably generated electric and thermic energy contains major flexibility regarding creative handling of wall and roof construction.

It is assumed that the high functional profoundness of wall and façade construction has to face increasing flexibility in design. Furthermore it is targeted to replace previously required layers (e.g. insulation, water-bearing layer etc.) with integrated solar active layers. Both an ecological and economical overvalue are expected.

Following this approach building envelopes can provide great surface potential to gain thermal energy. "Regular" functions such as illumination, ventilation, insulation or even weather protection can be part of the electrical and thermal energy generation. The view on energy generation within the building envelope will no longer be influenced by the previously common attitude towards modular and technoid-like façades (vgl. Hegger et al., 2015).

While analyzing both relevant design characteristics of façades and roofs and economic effects of the chosen implementations the energetic yields of the respective component are analyzed for the annual trend by means of dynamic processes. Advantages and disadvantages of different construction variants will be discussed, weighted and optimized for specific assembly situations and parameters. This procedure serves the purpose of identifying essential characteristics relevant for the solar energetic activation of façade and roof. Therefore first thermic simulations will be carried out using the software Equa IDA Indoor Climate and Energy (IDA ICE).

Through an iterative exchange process of the project team architectural, creative, energetic and economic aspects of the life circle are weighed. Seen from the present project status a solar energetic activation of the building envelope appears to be only expedient if the component-specific view is not only based on a singular optimization following a maximization of energy yield but also on all aspects of an architecturally high-quality planning of the façade and building envelope.

2.3 PROTOTYPICAL MOCK-UP APPLICATION

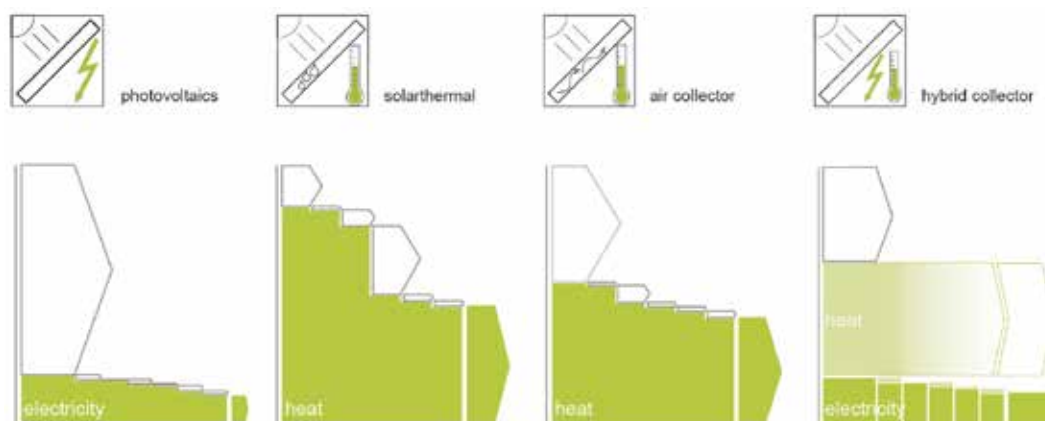

FIG. 4 Potentials for solar energy usage

Research on the solar potential of different building types from the typology catalogue as well as specific creative, constructive, energetic, judicial and economic integration possibilities according to the component catalogue result in planning and construction of a prototypical façade element. On that basis an architectural possibility of integration of solar active systems within the envelope shall be shown exemplarily. The construction of an office façade is planned making an international transfer on common office grids possible. Overall it is planned to build a section of 2 office axes and a common floor height. Besides a creative and constructive development more detailed studies concerning the energetic behavior are planned. The objective is to realize a hybrid system with thermal and electrical energy generation, which will be able to get an optimum of energetic utilization while using a minimum of technical effort. Especially research over thermal processes will be made using dynamic simulations with the program IDA-ICE and by a planned monitoring phase of the functional structure.

3 CONCLUSIONS AND OUTLOOK

In the future the use of solar energy will be a self-evident part of the architectural planning process and become a "conventional" element of the building envelope, provided that the passive and active use of solar energy will already become part in the early service phase of the architectural planning process. Basis and reference work therefore shall be the typological, constructive and economic potential studies.

Furthermore the present focus on only electricity based systems will be questioned critically. It is assumed that further energy potentials can also be activated using low-temperated waste heat of photovoltaic. So far electric systems were ventilated to reduce the loss of earnings due to heat exposure not taking into consideration the active use of waste heat. Using dynamic observation tools for energetic patterns makes it possible to contemplate effects of saving and phase shift realistically which were not considered in static balances yet.

Overall it is assumed that the border between passive and active solar energy use will blur more and more. Hybrid systems could be an interesting advancement of solar energy use and therefore solar heat gaining could again gain more significance.

Alternatively to a maximization of earnings (e.g. increase of effectiveness, optimal roof pitch etc.) a substitution of functions and simplification of layer structures could lead to a new climate and cost efficiency. The energetic behavior and its ecological impact seen over the whole live circle are crucial.

During the previous progress the following questions have been identified and probably could be partly answered in the further development:

- How could the expansion of solar energy generation be promoted based on typology? Which legal (construction law, tenancy law etc.) or social (e.g. age structure of inhabitants etc.) rules are contrary to a typology based expansion?
- How could the concept of „solar energy as functional component“ further be strengthened within the architectural planning process?
- With which parameters (maximum earning, self-sufficiency, relief of the network, autarky etc.) a future sustainable regenerative energy use should be evaluated for prospective building standard? How has regulatory law to be adapted?
- Which impact will energy savers and further measures of load shift have on solar energy gain and efficiency?
- Which willingness to pay does exist concerning solar active systems in the construction industry?
- Which possibilities and limits can be found in the context of energy and climate targets by the use of solar active components (new construction and rehabilitation)? Which strategic benefit can be generated from solar active components for energy revolution? And how should a legal framework look like to make present potentials usable throughout sectors?

Acknowledgements

This project is promoted by the Forschungsinitiative Zukunft Bau, Bundesministerium für Umwelt, Naturschutz, Bau und Reaktorsicherheit (Code: F20-14-1-038 - 10.08.18.7-15.57) and Goldbeck New Technologies GmbH as third-party donor

References

- Deilmann, Harald, Bickenbach, Gerhard, & Pfeiffer, Herbert. (1977). Wohnbereiche Wohnquartiere Housing Groups Zones d'habitat. Stuttgart: Krämer.
- Everding, Dagmar. (2007). Projekte, Lösungsmodelle und Anforderungsprofile eines solaren Städtebaus. In Dagmar Everding (Ed.), Solarer Städtebau. Stuttgart: Kohlhammer Verlag.
- Hegger, Manfred, Dettmar, Jörg, Martin, Alexander, Meinberg, Thomas, Boczek, Barbar, Drebes, Christoph, . . . Zelmer, Andrea. (2012). Eneff:Stadt | Forschungsprojekt „UrbanReNet“ Vernetzte regenerative Energiekonzepte im Siedlungs- und Landschaftsraum - Schlussbericht (Vol. Schlussbericht). Darmstadt.
- Hegger, Manfred, Drebes, Christoph, & Wurzbacher, Steffen. (2015). benefit E Gebäudeintegrierte solaraktive Systeme - Strategien zur Beseitigung technischer, wirtschaftlicher, planerischer und rechtlicher Hemmnisse. Retrieved 22.11.2015 http://www.ee.architektur.tu-darmstadt.de/media/architektur/fachgruppe_c/ee/forschung_dissertationen_4/ordner/151112_benefit_E_Endbericht.pdf
- Roth, Ueli. (1980). Wechselwirkungen zwischen der Siedlungsstruktur und Wärmeversorgungssystemen : Forschungsprojekt BMBau RS II 4-704102-77.10 (1980). Bonn: Bundesminister für Raumordnung, Bauwesen u. Städtebau.
- Vallentin, Rainer. (2011). Energieeffizienter Städtebau mit Passivhäusern, Begründung belastbarer Klimaschutzstandards im Wohnungsbau (Vol. 1. Aufl.). München: Cuvillier, E.

FAÇADE DESIGN

Research and Development of Innovative Materials at the Convergence of Art, Architecture and New Technologies

Heike Klussmann¹, Thorsten Klooster²

- 1 Prof. Heike Klussmann, Universität Kassel, Forschungsplattform BAU KUNST ERFINDEN // BUILDING ART INVENTION, Fachbereich Architektur, Stadtplanung, Landschaftsplanung, Henschelstr. 2, 34127 Kassel, Tel. +49 -561 -804 2396, E-mail: klussmann@asl.uni-kassel.de
- 2 Dipl.-Ing. Architekt Thorsten Klooster, Universität Kassel, Forschungsplattform BAU KUNST ERFINDEN // BUILDING ART INVENTION, Fachbereich Architektur, Stadtplanung, Landschaftsplanung, Henschelstr. 2, 34127 Kassel, Tel. +49 -561 -804 2396, E-mail: thorsten.klooster@b-k-e.org

Abstract

This article describes the development of several novel materials and manufacturing processes that may be regarded as a contribution of ideas for the material basis of innovative building envelopes. Since 2009 the authors have headed the BAU KUNST ERFINDEN // BUILDING ART INVENTION research platform for experimental material research at the University of Kassel, Germany, which brings together experts from the fields of visual art, architecture, interaction design, industrial design, experimental physics, IT, and robotics. Research project are regarded as exchanges initiated from the artist's position, in which ways of knowing and working that are specific to the sciences are harnessed in order to position and deploy them in artistic contexts-and vice versa.

Keywords

material research, art and science, art architecture technology, solar concrete, touch sensitive concrete, light reflecting concrete, smart materials, smart infrastructure, high tec low budget materials

1 RESEARCH AND DEVELOPMENT OF INNOVATIVE MATERIALS AT THE CONVERGENCE OF ART, ARCHITECTURE, NEW TECHNOLOGIES

"God made the bulk, the surface was invented by the devil." ¹ Wolfgang Pauli, quantum physicist, 1900 – 1958

Boundary surfaces determine the reality of the world we live in. They define and catalyze the processes of life, whether as cellular membranes, skin, the immune system, or between different ecological fields. Phenomena at material boundaries play a role in many important areas, whether visible and usable in daily life or removed from sight, as in the applied natural sciences, in nanotechnological materials research, or at the level of biotechnological and chemical processes (catalysis, filtration, electrophoresis). Connections to the production of art and architecture show up in the material appearances of surfaces, in their media representations in photography, film, and digital image media, but also in experiences of indifference like Duchamps' concept of inframince, which is the almost imperceptible separation (or "simultaneous delay") between two adjacent events or states.²

In architecture, terms like façade and shell designate many-faceted situations.(Fig. 1) With his statement about the house as a second skin extending our sensory system, Michel Serres has been one of the clearest in expressing the idea of the envelope or shell of a building as a significant synthetic extension to our bodies, that aids us in relating to our surroundings.³ Here, concepts of the membrane and the surface stand for a system's openness, while concepts of the boundary stand for its closure. In fact, the permeability of the shell is an essential measure of the relationship to the environment. Our fundamental ability to live is determined by this degree of connection, quite apart from the state of technology, culture, and mastery of nature: we maintain ourselves as closed systems by being open systems.⁴

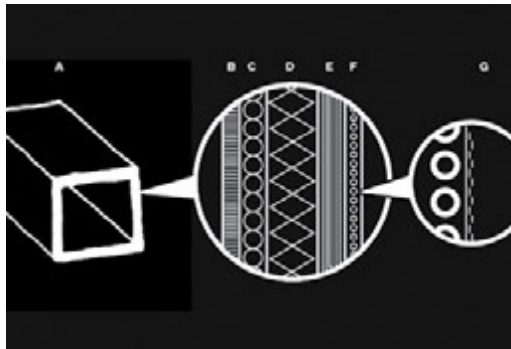

FIG. 1 Layer principle: The linocut shows a shift of attention from the appearance of materials to the performance of surfaces, Linocut: T. Klooster & onlab



FIG. 2 DysCrete, TouchCrete, BlingCrete: Concrete-Surfaces with an energy-generating or light-generating or sound-reducing or information-providing function R&D BAU KUNST ERFINDEN // BUILDING ART INVENTION, University of Kassel, T. Klooster and H. Klussmann, Photo: Bläfield

In the design of objects and spaces, considerations concerning surfaces are generally understood to be a decision on materiality. According to the words of Nobel Prize Winner Wolfgang Pauli: 'The material is divine'. With current debate, the design and development of so-called 'divine' materials based on the principles of biological growth, or the simulation of the physical forces that act upon them, enables us to produce complex geometries that recall myriad living systems – on which

they were often modeled in the first place. This can often approximate to living systems' ways of functioning, without actually achieving it. Hence there is something here of an unfulfilled promise, but one which the investigation of surfaces touches upon – with the inherent possibilities of “enlivening” materials by taking the surface as a starting point both conceptually and technically.

At present, materials research has arrived at the molecular level, on which electrostatic natural forces dominate over the forces of gravity and inertia relevant on the macro level. Many new materials are therefore determined now by their micro and nano scale properties as well as by their visual and physical macro ones. In design and the arts, design theorist Ramia Mazé describes this ‘strategy of enlivenment’ as a change of focus from the appearance of a material to the performance of surfaces: ‘As structural, chemical and computational properties are integrated at nano-, micro- and macro-scales, even the most traditional material might become more dynamic.’⁵ Along with the Italian material researcher Ezio Manzini, we can speak of a technologisation of materials, which increasingly allows designers to determine their behaviour in advance, rather than simply taking it into account.⁶

In seeming sobriety, material technology research is concerned with what it simply calls the function of a surface. In a technical respect, we are pursuing the approach of a functionalization of surfaces. This could for instance be a protective function, but could also refer to an energy-generating function, or to light-generating or sound-reducing or information-providing surfaces. (Fig. 2) These terms allow the technological characteristics to be ordered in a meaningful manner, whilst at the same time describing their current application prospects for both research and design. Design strategies that are appropriate for surfaces arise from this congruence. A discussion of surfaces permits inclusion of the term skin, together with the principles, material concepts and philosophies on which it is based (from an engineering science, building construction and design point of view). For the significance of the term ‘surface’ is the same as far as technical research and design are concerned, and on account of this versatility, the word lends itself particularly well to making a broad spectrum of current developments in other disciplines accessible to design. Helpfully also, the concept of surface furthermore has a meaning in the humanities, and in the arts, thus making important, yet disparate contents accessible. Surface has become the arena in which both the status quo and the improvement of substances can be represented. It has become an interdisciplinary space of negotiation.

2 ENERGY, LIGHT, SOUND AND INFORMATION

The BAU KUNST ERFINDEN // BUILDING ART INVENTION research platform at the University of Kassel has positioned itself in this interdisciplinary field that is becoming increasingly important for art, architecture and material research: smart materials and smart infrastructure. We are interested in possibilities and strategies for structuring materials according to determinable principles, and for functionalizing and designing them by means of mutually interdependent processes. To guide our efforts, we have divided our work into subject areas: Energy, Light, Sound and Information. With the same lucidity they bring to the categorization of technological developments, these terms also delineate potential applications with contemporary relevance for research and design. The concept of „skin” or “surface” encompasses widely disparate ideas, holding equal significance in technology research, the arts and the humanities. Because of this complexity, we feel it is appropriate to bring together contemporary developments from various disciplines. Artistic strategies, pure science and the practically oriented strategies of engineering overlap in our projects. Our actions follow the dictum that “Making is Knowing” (Peter Galison).

The thematic range of this introduction holds relevance for the BlingCrete project, which was the first project located in the context of a transdisciplinary research process at the University of Kassel. That process brought together experts from the fields of visual art, architecture, interaction design, industrial design, experimental physics, and materials research. It is, first of all, a project devoted to realizing a material concept: a light-reflecting concrete. This new material combines the positive qualities of concrete (fire resistance, strength, construction technology) with the property of retroreflection. Retroreflective surfaces reflect incident light (natural or artificial) precisely back to its source. This optical phenomenon is produced by glass microspheres embedded in a concrete substrate.

The idea for this substance arose from artistic experimentation with light-reflecting materials used in road construction, whose high flammability precludes their use in permanent indoor applications. It is worth noting in this connection that the path to the solution can be portrayed as a transfer process which, even on the technological level, necessitated a conversation, initiated by addressing the concept of boundaries in order to achieve its objectives. But the combination of glass and concrete in a single composite is significant for other reasons as well, considering that with this combination BlingCrete unites two of the most antithetical positions imaginable in material aesthetics, which are linked to seemingly axiomatic discourses in visual art and design. We would like to show how, through the analysis and creative interpretation of such antagonisms, BlingCrete has evolved via the materials-development process from visual art into an experimental system that catalyzes both artistic and scientific lines of inquiry in equal measure and promotes dialogue about them. The substantive aspects of the term "surface" define a space for interdisciplinary negotiation in which the project unfolds. BlingCrete is both materials development and the prototype for a transdisciplinary research process.

3 LOW-TECH SOLUTIONS IN A HIGH-TECH WORLD

With BlingCrete, TouchCrete and DysCrete, the R&D platform BAU KUNST ERFINDEN // BUILDING ART INVENTION has developed three novel standards of concrete, enabling this material to be lightreflecting, informationconveying, and energygenerating for the very first time. Novel material systems like POLA - sound absorbing concrete, and CCMYK – vibrantly colored concrete, Plotbot/ Crawler – mobile concrete printer, and Joyn Machine – a rapid manufacturing web augmented joinery machine, all invented by BKE, may as well be seen as a paradigm of new ways for the building process, of high tech low cost construction materials, and manufacturing processes, as the transdisciplinary design of materials leads to a whole complex of innovative applications.

4 DYSCRETE – A NEW LOW COST ENERGY SOURCE

DysCrete is an innovative approach to the generation of energy, based on the same underlying principles as dye-sensitized solar cells (DYSC), from which it gains its name. (Fig. 3) Like other cells based on DYSC technologies, DysCrete uses organic dyes to absorb light and produce electricity through electrochemical reactions. The analysis of this still novel process reveals a high degree of compatibility between DYSC technology and the chemistry and physics of concrete, including its material logic and production methods. DYSC cells are modeled on nature. Much like chlorophyll-bearing plants, they absorb light not with semiconductor materials, but with organic dyes held in suspension. In this sense, the technology is an adaptation of the photosynthetic process. Technically, the DysCrete cell is based on a precise structure of functional layers. These combine to form a redox reaction coating that generates energy through an electrochemical process when exposed to light. This coating can be created on concrete surfaces by systematically modifying their physical and chemical structure while applying and integrating specific substances. The electricity-generating material is refined through a process of synthesis and layering, a combination of sintering and spray deposition that can easily be integrated into the production of prefabricated elements. By adjusting the dye and electrolyte components, the layer system can be tuned to specific wavebands of light, including the very edges of the visible spectrum. The energy-generating function is produced with freely available components, with no additional toxic emissions. The innovative system of materials is renewable, largely recyclable and environmentally friendly. Because it can make use of the energy in diffuse light, its structural applications are virtually unlimited compared to conventional photovoltaic systems, opening up a world of possibilities in the field of structurally integrated photovoltaics. (Fig. 4) Another major advantage of dye-sensitized concrete is its relatively low production cost, giving the system great potential as a low-cost energy source.



FIG. 3 Prototype of DysCrete – Solar Concrete R&D: BAU KUNST ERFINDEN // BUILDING ART INVENTION, University of Kassel, T. Klooster, S. Aden, J. Iwanowicz and H. Klusmann, in cooperation with J. Arendt, A. Wetzel and B. Middendorf, WDBB, University of Kassel, funded by the Forschungsinitiative Zukunft Bau/ BBSR, Photo: BAU KUNST ERFINDEN



FIG. 4 Prototype of the electric system of a DysCrete- Solar Concrete - PV-Panel R&D: BAU KUNST ERFINDEN // BUILDING ART INVENTION, University of Kassel, T. Klooster, S. Aden, J. Iwanowicz and H. Klusmann, funded by the Forschungsinitiative Zukunft Bau/ BBSR, Photo: BAU KUNST ERFINDEN

5 TOUCHCRETE – VISUAL PERCEPTION ENHANCED BY TACTILE EXPERIENCE

TouchCrete adds a sensory component to concrete's positive qualities as a structural material (fire resistance, high strength and durability, variety of construction methods, etc.): a high-tech, lowbudget structural product, optimized in terms of its technical, functional and aesthetic qualities, TouchCrete can be used for programming interactions and for designing Tangible User Interfaces, and measurement and control technologies. The idea of TouchCrete is closely associated with communication, and with information, concerned with space. It promotes the linkage of disparate contexts. Changes in the proximity are detected (depending on required signal resolution) and localized by the structural element and then relayed as signals to the signal-processing unit (control unit). An important part of the TouchCrete approach is the development of a novel concrete component (Agile Compound) (Fig. 5), that is including an, or rather acting as an entire Actor-Sensor device comprising sensors, actuators, and a control unit. In this sense, TouchCrete also investigates the development of high-tech low budget building elements according to the principles of the Internet of Things (IoT). In the context at issue, IoT is to be understood as the network of physical devices, vehicles, buildings and other items – embedded with electronics, software, sensors and network connectivity that enables these objects to collect and exchange data. In 2013 the Global Standards Initiative on Internet of Things (IoT-GSI) defined the IoT as "the infrastructure of the information society." The IoT allows objects to be sensed and controlled remotely across existing network infrastructure, creating opportunities for more direct integration of the physical world into computer-based systems, and resulting in improved efficiency, accuracy and economic benefit. When IoT is augmented with sensors and actuators, the technology becomes an integral feature of the more general class of cyber-physical systems, which also encompasses technologies such as smart grids, smart homes, and smart cities.

The characteristics of TouchCrete open up a wide array of interactive and sensory possibilities in the design of smart infrastructure, superstructures, and buildings. Because it allows seamless panel integration, potential applications include: highly vandalism-resistant interactive systems in public areas (kiosk systems, information terminals, wayfinding systems, parking meters, ticket machines); integrated sensor controls (water level meters, locking systems, people counters, traffic monitoring); logic circuits with fully integrated (same-level) switching elements (light switches, dimmers, switched outlets, door openers); complex control interfaces for networked constructions (smart roads), building (smart home) systems; and uses in hygiene-critical areas (food industry, hospitals). Surfaces can be designed with function-specific or instructive patterns. Designs can be adapted to the users own needs. Nonmechanical switches are fully implementable with TouchCrete, and entire wall surfaces can be designed to function as touchpads. The main components of this synthetic material (or sensor-actor system) are a new type of conductive concrete (the sensor) and a signal-processing unit. The actors in the system can be any components, devices or functional elements of a building's technological systems (light, ventilation, heating, acoustics, data), as well as the controls for household and other electronic devices. Conductive concrete can be used as an information conduit for intuitive gestural control, or as a sensory detection device. TouchCrete adds a sensory component to concrete's positive qualities as a structural material (fire resistance, high strength and durability, variety of construction methods, etc.). Sensitive concrete surfaces (inductive or capacitive sensors) allow touches to be recognized and processed as control commands. With minimal modifications, gestural controls like those used in smartphones and tablets can be implemented in homes, offices and outdoor spaces. Electronically controlled devices can be operated with a simple touch, intuitive swipe or typed command on a concrete surface. (Fig. 6)

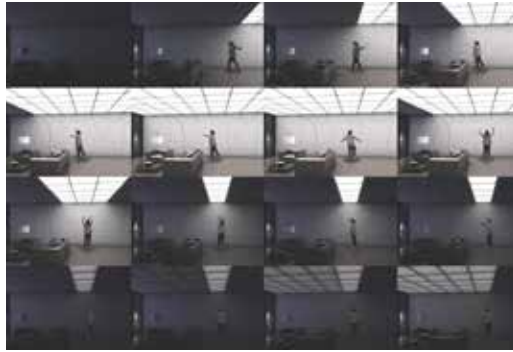

FIG. 5 TouchCrete – Touch Sensitive Concrete R&D: BAU KUNST ERFINDEN // BUILDING ART INVENTION, University of Kassel, T. Klooster, R. Polster, J. Juraschek, V. Santagati, P. Taylor and H. Klussmann, Photo: P. Taylor

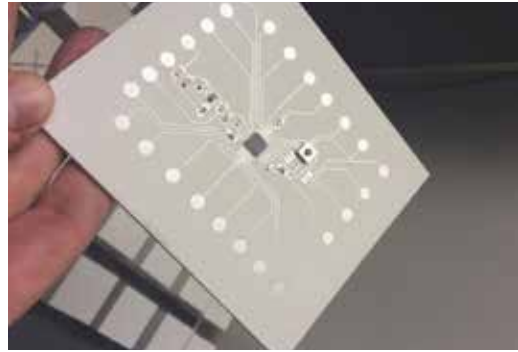

FIG. 6 Prototype of a PACE ultra thin textile reinforced concrete element with a freely programmable control unit for Agile Compunds R&D: BAU KUNST ERFINDEN // BUILDING ART INVENTION, University of Kassel, J. Iwanowicz, T. Klooster and H. Klussmann, Photo: BAU KUNST ERFINDEN

6 BLINGCRETE – LIGHT REFLECTING CONCRETE

BlingCrete represents a new genre of materials with its own logic of effect that cannot be described simply in terms of the usual categories of heavy and light or form, construction, and surface. The material is the only light-reflecting material non-combustible. It combines the positive characteristics of concrete (fire safety, solidity, building methods) with those of retroreflection. Retroreflecting surfaces send incoming rays of light (sunlight or artificial light) back precisely in the direction of the source. This optical phenomenon is produced by embedding glass microspheres in the substrate material. Crucial for the reflective power are the roundness, clarity, and refractive index of the beads, as well as the bond between the glass microspheres and the substrate. The dialog with light, lastingly integrated by the combination of materials, creates the special, dematerialized aesthetic. BlingCrete™ creates immersive environments by lowtech analogue modes. BlingCrete is currently the only lightreflecting material that is non-flammable. The potentials of BlingCrete open up various design possibilities in the areas of architecture, interior design and in transport safety. Potential applications are, for example, safety-related marking of danger spots in construction (stairs, sidewalks, platform edges and tunnels), as well as the design of integrated guidance systems and novel surface components (façade, floor and ceiling). BlingCrete facilitates new and unexpected ways of perception. In principal it is an unobtrusive material that is eye-catching or even flamboyant when required. The information is latently stored in the surface without dominating the architecture, its visibility is affected by the users' walking paths and the position of the light, making it fully visible at specific points. It is the concept of a material admitting the creation of subtle surfaces that manage to mediate between material and light and thus indirectly referring to the relationship between mass and surface. (Fig. 7)

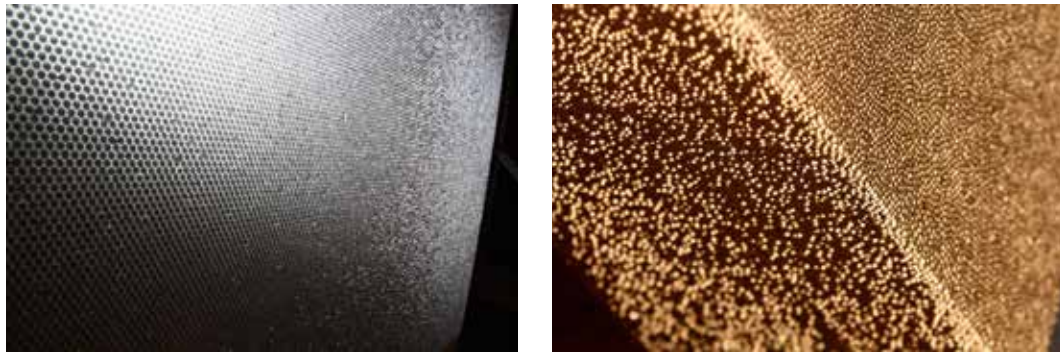

FIG. 7 BlingCrete – Light reflecting concrete, R&D: BAU KUNST ERFINDEN // BUILDING ART INVENTION, University of Kassel, T. Klooster, R. Polster, J. Juraschek, M. Hellmann, F. Ecke and H. Klussmann, funded by the BMWi/ ZIM, Photo: BAU KUNST ERFINDEN

7 POLA SOUND ABSORBER, JOYN MACHINE AND SALIX REGIONALIS 3D

Novel material systems like POLA – sound absorbing concrete, and Salix– a new lightweight, customizable willow-based construction material, Plotbot/ Crawler – mobile concrete printer, and Joyn Machine – a rapid manufacturing web augmented joinery machine may as well be seen as a paradigm of new ways for the building process, as the transdisciplinary design of materias leads to a whole complex of innovative applications.



FIG. 8 Prototype of POLA – broadband absorber for mid-range and low frequencies made of TRC, R&D: BAU KUNST ERFINDEN // BUILDING ART INVENTION, University of Kassel, A. Eckardt, T. Klooster, F. Ecke, M. Hellmann, D. Becker and H. Klussmann, funded by the BMWi/ ZIM, Photo: BAU KUNST ERFINDEN

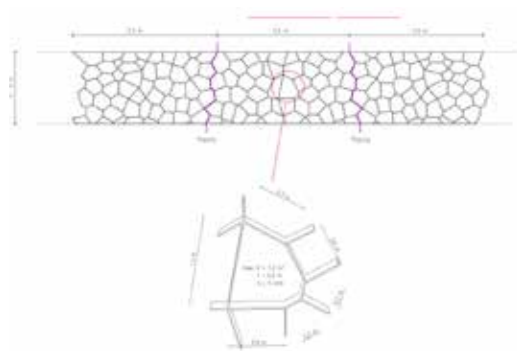

FIG. 9 POLA structure – main principles of prefabricated continuous interlocked POLA construction R&D: BAU KUNST ERFINDEN // BUILDING ART INVENTION, University of Kassel, T. Klooster, A. Eckardt, M. Hellmann, F. Ecke, D. Becker and H. Klussmann, funded by the BMWi/ ZIM, Drawing: BAU KUNST ERFINDEN

POLA stands for Parametric Open Field Lightweight Absorber. It is a unique transparent sound absorber especially designed for critical public areas, where noise is otherwise difficult to control. It is acoustically highly effective due to the precise parametric arrangement of absorber volumes constituting the sound proofing elements. It is based on the principles of Helmholtz resonators of mutually different frequency. using air as the absorber material. Instead of bulky additional implementations, elements appear as a minimalistic light weight construction made of a novel Textile Reinforced Concrete TRC. POLA may work as a transparent noise barrier, act as a part of

the load carrying construction, or as a noise absorbing facade. POLA elements may be adapted individually and precisely to existing environment and to sound requirements. Elements are at first made of novel sound optimized textile reinforced HPC and UHPC. Systems are also obtainable in other materials like wood or aluminium. Elements are manufactured with a novel parametric precast manufacturing formwork that is easy to adapt to existing production lines. (Fig. 8 / Fig. 9).

Salix 3D is a new lightweight construction material for the production of ultra-light, dimensionally stable and elastic molded wooden parts made of willow. Inspired by the centuries old tradition of basketweaving Salix 3D is an investigation of willow in the form of whites (split and whole) and strips. Willow possesses exceptional qualities of tensile strength and flexibility. A fast growing, coarse grained wood, it is quite light, even in large quantities, which gives Salix the characteristics of a lightweight stable, individually moldable, customizable wood-based construction material. With machines specifically developed designed for an improved manufacturing process, osier stakes are arranged in a planar manner into application-related stress-differentiated fabrics, or layers, and then transformed by molding presses with temperature. Areas of application of this novel lightweight construction material are architecture, design and automotive construction. Salix 3D elements are up to 40% lighter than conventional solid wooden parts. SALIX 3D stands for structural lightweight construction and thus for resource-optimized design and sustainability.

The willow (lat. Salix) is a renewable high-tech material to be found in almost all rural areas of Europe and thus a valuable material resource. Despite its excellent properties, it is now used almost exclusively as an energy plant in Europe, since its processing has so far been based solely on manual methods. Salix 3D is the combination of traditional craftsmanship with digital know-how, as well as of modern textile technology and advanced wood technology. (Fig. 10)



FIG. 10 SALIX REGIONALIS 3D is a new lightweight construction material made from willow, R&D: BAU KUNST ERFINDEN // BUILDING ART INVENTION, University of Kassel, S. Silbermann, T. Klooster, J. Juraschek, D. Becker and H. Klussmann, funded by the BMWi/ ZIM, Photo:BAU KUNST ERFINDEN

Joyn Machine is a rapid manufacturing joinery machine. Its purpose is to develop an innovative web-augmented machine for the production of custom wood constructions with milled joints. An user-friendly tightly arranged, a standardized joinery system, an app-based interface, and an online platform for the exchange and evaluation of designs are combined to create a new kind of tool. Established woodworking methods, including industrial-scale processes, are refined and brought together in an intelligent system that is flexible and user-friendly. Using a logically interlinked system of tools and materials, digital designs can be turned into components that are then assembled into objects and structures. (Fig. 11)

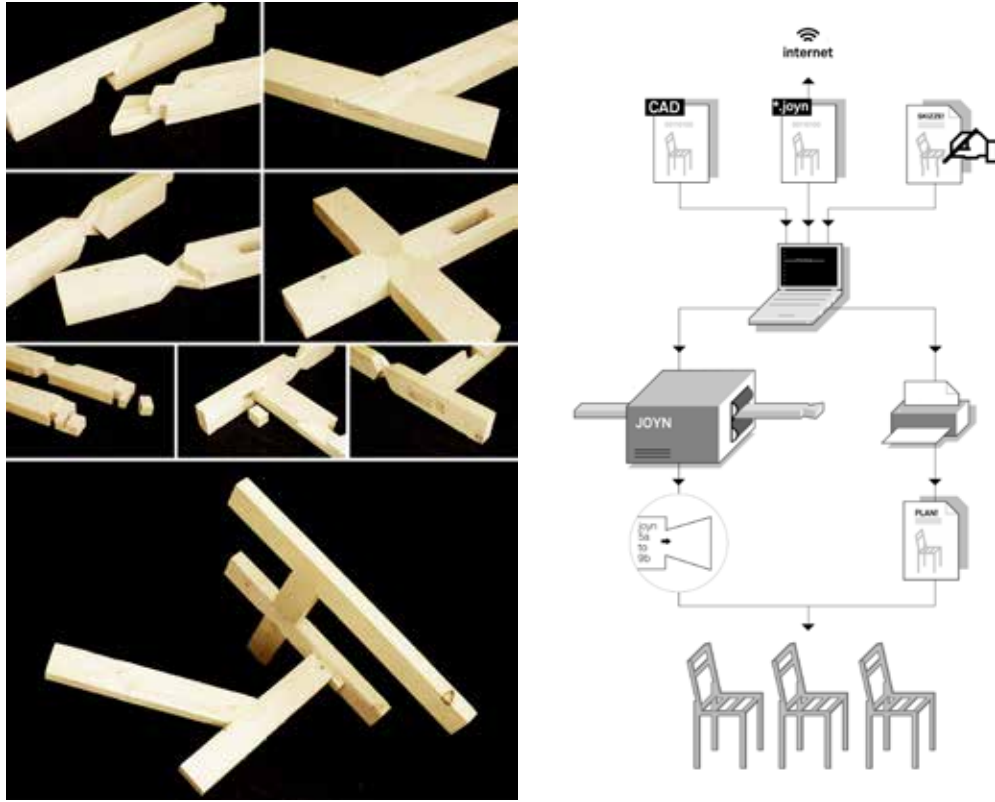

FIG. 11 JOYN MACHINE is a rapid manufacturing joinery machine for the production of custom wood constructions with milled joints. R&D: BAU KUNST ERFINDEN // BUILDING ART INVENTION, University of Kassel, S. Deeg, A. Picker, T. Klooster and H. Klussmann, funded by the BMWi/ ZIM, Photo: BAU KUNST ERFINDEN

Endnotes

- Jamtveit, B., Meakin, P., (1999) „God made the bulk, the surface was invented by the devil.“ Quoted in Growth, Dissolution, and Pattern Formation. Geosystems, p. 291.
- Hanimann, J. (1986). INFRA-MINCE oder das unendliche Dazwischen. Zu einem Begriff aus dem Nachlass Marcel Duchamps, Pantheon, Bd. 44, pp. 134-140.
- Benthien, C. (2001). Haut. Literaturgeschichte – Körperbilder – Grenzdiskurse. Reinbek: Rowohlt, p. 38.
- Reichholf, J. H. (2008). Stabile Ungleichgewichte. Die Ökologie der Zukunft. Frankfurt: Suhrkamp, pp 137.
- Mazé, R. (2007). Occupying time: Design, technology, and the form of interaction. Stockholm: Axl Books, pp. 35.
- Manzini, E. (1989). The material of invention. Cambridge, MA: MIT Press.

References

- Peters, S. Hrsg. (2015). Additive Fertigung. Band 25 der Schriftenreihe der Technologielinie Hessen-Nanotech des Hessischen Ministeriums für Wirtschaft, Energie, Verkehr und Landesentwicklung.
- Basrawi, C. (2014). Intelligente Oberflächen. Merkur - Deutsche Zeitschrift für europäisches Denken. Heft 5, 68. Jahrgang, pp. 412 - 421.
- Ennen, I., Höink, V., Weddemann, A., Hütten, A., Schmalhorst, J., Reiss, G., Waltenberg, C., Jutzi, P., Weis, T., Engel, D., Ehresmann, A. (2007). Manipulation of Magnetic Nanoparticles by the Strayfield of Magnetically Patterned Ferromagnetic Layers. Journal of Applied Physics, Nr. 102 (2007), pp. 013910.
- Fehling, E., Schmidt, M., Stürwald, S. (2008). Ultra High Performance Concrete (UHPC). Proceedings of the Second International Symposium on Ultra High Performances Concrete 2008.
- Ghufuran Hashmi, S., Moehl, T., Halme, J., Ma, J., Saukkonen, T., Yella, A., Giordano, F., Decoppet, J., Zakeeruddin, S., Lund, P. & Grätzel, M. (2014) A durable SWCNT/PET polymer foil based metal free counter electrode for flexible dye-sensitized solar cells, J. Mater. Chem. A, 2014, 2, pp. 19609-19615.
- Bach, U., Lupo, D., Comte, P., Moser, J. E., Weissörtel, F., Salbeck, J., Spreitzer, H. & Grätzel, M. (1998). Solid-state dye-sensitized mesoporous TiO₂ solar cells with high photon-to-electron conversion efficiencies, Nature 395, pp. 583-585.
- Mori, T. Hrsg. (2002). Immaterial/ Ultramaterial: Architecture, Design, and Materials. Cambridge, MA, New York.
- Klooster, T., Klussmann, H. (2016). Kontextsensitiver Beton – Physical Computing Concrete, Betonbauteile 2016, Gütersloh: Bauverlag BV GmbH, pp. 150 -155.
- Klooster, T., Klussmann, H. (2015). DysCrete – Sonnenstrom aus Beton. Hessen-Nanotech, Schriftenreihe des Hessischen Ministeriums für Wirtschaft, Energie, Verkehr und Landesentwicklung, pp. 12-13
- Klooster, T., Klussmann, H., (2013) BlingCrete. Performative Materials in Architecture and Design. Intellectbooks Ltd., The University of Chicago Press, Bristol, UK / New York, US, pp. 97-99
- Klooster, T., Klussmann, H. (2012): BlingCrete – Materialentwicklung als transdisziplinärer Forschungsprozess. Kunstforschung als ästhetische Wissenschaft. Bielefeld: transcriptverlag, pp. 49-64
[R&D Projects]
- DYSCRETE – ARC Centre of Excellence in Exciton Science (ACOEES), Funding: Australian Research Council, Project leader ACOEES: Prof. Paul Mulvaney as the Chair (University of Melbourne, Director of ACOEES), Prof. Udo Bach (Monash University, Deputy Director of ACOEES) Centre COO, Project leader DysCrete: Prof. Heike Klussmann, Dipl.-Ing. Architekt Thorsten Klooster (Research Platform Building Art Invention / University of Kassel), www.excitonscience.com
 - DYSCRETE – DFG / Initiating international cooperation with the Monash University, Melbourne Australia, Project leader: Prof. Heike Klussmann, Dipl.-Ing. Architekt Thorsten Klooster, in cooperation with Prof. Udo Bach and Dr. Tim Schork, Monash University, Funding: DFG – Deutsche Forschungsgemeinschaft/ German Research Foundation, www.dfg.de
 - DYSCRETE – BMUB / Forschungsinitiative Zukunft Bau im BBSR/ Future Building Research Initiative, Project team: Research Platform Building Art Invention / University of Kassel / Prof. Heike Klussmann, Dipl.-Ing. Architekt Thorsten Klooster, Dipl.-Ing. Jan Iwanowicz, Samira Aden M.Sc. in cooperation with FB 14, WdBB, University of Kassel, Prof. Bernhard Middendorf, Dr. Alexander Wetzel, Dipl.-NanoSc. Johannes Arendt, www.forschungsinitiative.de
 - BLINGCRETE – BMWi / Bundesministerium für Wirtschaft und Technologie/ ZIM – Kooperationsprojekt, Project team: Research Platform Building Art Invention / University of Kassel / Prof. Heike Klussmann, Dipl.-Ing. Architekt Thorsten Klooster, Dipl.-Ing. Roman Polster, Magdalena Hellmann M.Sc., Frederik Ecke M.Sc., Jan Juraschek B.Sc
 - MAGNETIC POSITIONING – BMWi / Bundesministerium für Wirtschaft und Technologie/ ZIM – Kooperationsprojekt, Project team: Research Platform Building Art Invention / University of Kassel / Prof. Heike Klussmann, Dipl.-Ing. Architekt Thorsten Klooster, Dipl.-Ing. Roman Polster, Jan Juraschek B.Sc., Samira Aden M.Sc. in cooperation with, FB 10, University of Kassel, Experimentalphysik IV - Funktionale dünne Schichten & Physik mit Synchrotronstrahlung, Prof. A. Ehresmann, Dipl.-NanoSc. Henning Huckfeldt
 - LOCAL RESOURCES / NEW MATERIALS – DAAD / Hochschuldialog mit der islamischen Welt. Project team: Research Platform Building Art Invention / University of Kassel / Prof. Heike Klussmann, Dipl.-Ing. Architekt Thorsten Klooster, Karen Winzer, Florian Gwinner, Dipl.-Ing. Roman Polster, Dipl.-Des. Simon Deeg, Dipl.-Des. Andreas Picker, Dipl.-Ing. Jan Iwanowicz, Nicolai Kudielka M.Sc., Lessano Negussie M.Sc., Dipl.-Des. Andre May in cooperation with German University of Technology in Oman, Prof. Jörg Baumeister, Dr. Daniela Ottmann
 - IM-PORT//EX-PORT / Ein Schiff für Kunst und Wissenschaft in Kassel – Stadt Kassel, Universität Kassel, Stiftungen & Sponsoren, Project team: Research Platform Building Art Invention / University of Kassel / Prof. Heike Klussmann, Dipl.-Ing. Architekt Thorsten Klooster, Nicolai Kudielka M.Sc., Lessano Negussie M.Sc., Dipl.-Des. Andre May
 - HOCHSCHULPREIS FÜR EXZELLENZ IN DER LEHRE 2012 – 1. Preis, des Hessischen Ministeriums für Wissenschaft und Kunst und der Hertiestiftung, Project Team: Research Platform Building Art Invention / University of Kassel / Prof. Heike Klussmann, Dipl.-Ing. Architekt Thorsten Klooster, Karen Winzer, Florian Gwinner, Dipl.-Ing. Roman Polster

- JOYN MACHINE – BMWi / Bundesministerium für Wirtschaft und Technologie/ ZIM – Kooperationsprojekt, Project team: Research Platform Building Art Invention / University of Kassel / Prof. Heike Klussmann, Dipl.-Ing. Architekt Thorsten Klooster, Dipl.-Des. Simon Deeg, Dipl.-Des. Andreas Picker
- SALIX REGIONALIS 3D – BMWi / Bundesministerium für Wirtschaft und Technologie/ ZIM – Kooperationsprojekt, Project team: Research Platform Building Art Invention / University of Kassel / Prof. Heike Klussmann, Dipl.-Ing. Architekt Thorsten Klooster, Dipl.-Des. Steffi Silbermann, Jan Juraschek B.Sc., David Becker
- PLOTBOT/CRAWLER – BMUB / Forschungsinitiative Zukunft Bau im BBSR/ Future Building Research Initiative, Project team: Research Platform Building Art Invention / University of Kassel / Prof. Heike Klussmann, Dipl.-Ing. Architekt Thorsten Klooster, Jan Juraschek B.Sc., Christian Wagner B.Sc., Nils Kühn
- TELA – BMWi / Bundesministerium für Wirtschaft und Technologie/ ZIM – Kooperationsprojekt, Project team: Research Platform Building Art Invention / University of Kassel / Prof. Heike Klussmann, Dipl.-Ing. Architekt Thorsten Klooster, Anke Eckardt M.A., Magdalena Hellmann M.Sc., Frederik Ecke M.Sc., David Becker

Retrofit of a “Brutalist” office building from the ‘70s in Rome

Alberto Raimondi¹

¹ Università di Roma Tre, Department of Architecture, Via Madonna dei Monti 40, 00184 Rome, Italy – alberto.raimondi@uniroma3.it

Abstract

Upgrading the existing building stock is one of the challenges for the near future. The replacement of the façade for most office buildings from the ‘60s to the ‘80s, is one of the main actions to increase their energy performance and inner comfort. Nevertheless, replacing the façades could have a big impact on the building’s appearance. The question that arises is: how can we refurbish listed buildings, maintaining the original features of their architecture? The case study that is presented in this paper is the retrofit of a “brutalist” exposed concrete office building from the ‘70s in Rome. The retrofit project aims to an overall improvement of the energy performance to make it compliant with the principles of CO2 emission reduction. The focus is on a new high-performance glazed façade with relevant thermal and acoustic performance and with a daylight integrated control system device. This building is listed in the Carta della Qualità della Città di Roma (Quality Chart of the City of Rome) drawn up to address and control transformations on the Roman architectural heritage. The intervention saved, therefore, the building’s original design by preserving volumes and materials and, especially, the exposed concrete façade. This paper focuses on the large size glass windows that identify the contemporary character of the project. The window frames dimension has significantly increased since the ‘70s and high-performance façade glazing cause a different appearance. Subsequently the change of the overall image of the building is a design issue. Design goals was to minimize the perceived dimension of the window frames and maximize the energy performances, at the same time give a new image to the building through the new façade.

Keywords

brutalist, retrofitting, Rome, heritage, façade.



1 INTRODUCTION

Upgrading the existing building stock is one of the challenges for the near future.

How can we refurbish listed buildings, maintaining the original features of their architecture?

The evolution of the energy efficiency expectations of buildings has increased significantly over the past 15 years, these rapidly increasing requirements for low consumption and low CO₂ emissions has introduced new practices in designing and building, and can be considered the most significant development in the construction industry in recent years. Introducing new efficient products, new methods of putting in place the elements of the building, new, more efficient plants, is therefore part of the innovations in contemporary construction. These innovations are relatively simple to implement in the project of a new building, however, their application in existing buildings, instead, is much more complex.

Retrofit of existing buildings is nowadays one of the main trends in the construction industry in Italy, the recovery of the buildings rather than demolition and reconstruction is a common practice in Italy, but today it takes on a greater meaning, a sustainability perspective. A conservative approach to the use of resources, one which is based on long life cycles and therefore positive in terms of sustainability, which increasingly influences all aspects of construction. In this context, making existing building stock energy efficient through refurbishment is of utmost importance (Clemens & Schulz, 2013).

Unlike a project for a new building, there is a higher number of variables or constraints to be respected for existing buildings and these vary from case to case. These constraints have different hierarchies and their complete or partial fulfilment is also part of the project. Achieving the best energy performance is a priority which must be reached by the project, but it must also be mediated by structural assessments, logistics, available space, costs, and image.



FIG. 1 The original building "ante operam" year 2008

In the office buildings from the '60s and '70s, the main part of the external shell is made of curtain-walls or large windows, but when we look at the architectural façade solutions of early Modern Architecture, it becomes apparent that they were relevant at their time, but no longer fulfil today's requirements (Knaack, Klein, Bilow, & Auer, 2014). The low temperature performance of these systems, combined to their considerable extension means that the façades are the factors on which to concentrate the main attention regarding refurbishment.

The buildings can have different types of constraints, based on their age and their architectural quality. In Italy, the matter is very complex, the great historical and architectural heritage is protected by numerous laws that determine the different levels of permitted intervention for protected buildings. There are different levels of constraints applicable to the architectural heritage, the highest level is the one that applies to monuments, then there are levels of protection concerning parts of buildings or specific aspects like their exterior appearance, or the respect of their shape and urban alignment in consolidated urban contexts.

This study case regards a five storey building entirely built in exposed reinforced concrete cast in situ, designed and built by the architect A. Ciaramaglia in 1973. The building that appears alien in a neighbourhood of the beginning of the 1900s is an unusual and brave example in the panorama of Roman civil construction (Rossi, 2009). This building is listed in the "Carta della Qualità della Città di Roma" (Quality Chart of the City of Rome), a document of the municipality in which the buildings that have special architectural features are listed.

The building was designed to be a retail building, now is the headquarters of Ghella spa, a main Italian construction company. His architecture follows the line from the "Brutalism" architectural vanguard from the '60, in Italy led by Luigi Pellegrin and Maurizio Sacripanti, and in the world, among others, by late Le Corbusier, Rudolf, Archigram and the Japanese metabolists.

In this building the common elements with brutalist architecture are the use of exposed concrete and the use of repeated modular elements forming masses for specific functional zones. Furthermore the use of the exposed concrete structure to reveal the function of each part of the building.

2 METHODOLOGY PROBLEM

2.1 WHAT TO MAINTAIN AND WHAT TO MODIFY?

There are no standard solutions for an energy retrofit of an historic building, but with the right approach, the appropriate solution for a particular building can be found. There are manifold technologies available; it's the task of the design team to select the right ones and adapt them to suit each building's needs (Troj & Zeno, 2015).

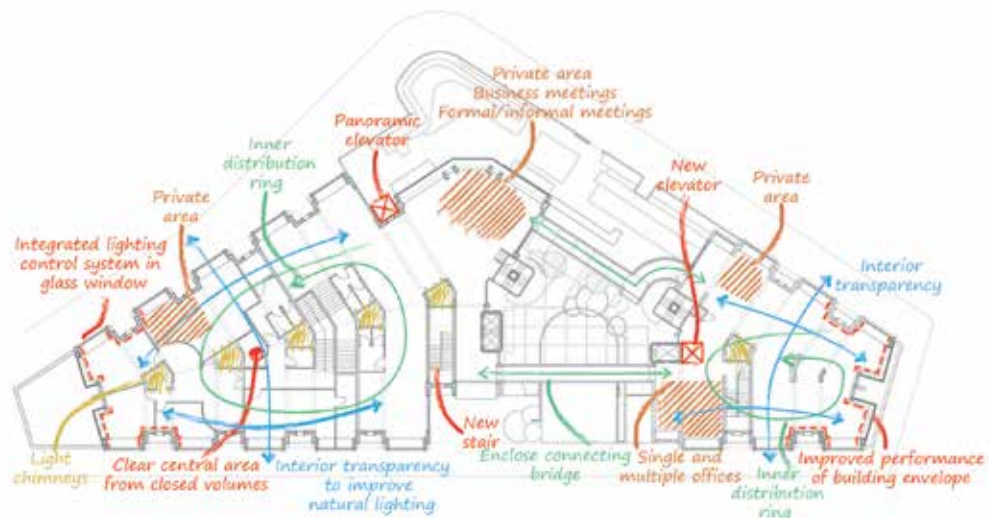

FIG. 2 The Retrofit design sketch

It follows that every transformation project contemplates an in-depth phase of understanding the state of being and then deciding which of the existing features should be retained, and which replaced or integrated.

The level of maintenance of the existing building is given by the ability to adapt to a new use, in the case of the Ghella offices the new target is to become the headquarters and head office of the construction company.

The maintenance is concise with the preservation of the reinforced concrete as the material for both load-bearing structures and for the infill works. The extensive use of exposed concrete was undoubtedly recognized by us as one of the qualifying features of Ciaramaglia's building. The other aspect was to maintain the complex articulation of the volumes and the geometry of the openings.

The replacement has affected all the elements that either for functional obsolescence or performance were no longer able to fulfil their role, such as fixtures, windows, floors, plants, lifts, interior stairs and false ceilings.

The integration involved elements that were not present and that have been added with the specific objectives to provide new features not present, such as solar tubes, glass partitions, thermal insulation, thermal solar and PV systems, plant control systems, new vertical connections.

Therefore, the project has the goal of maintaining the original character of the building preserving the volumes and the materials, in particular recognizing the use of the concrete in view, which is the prevailing character of this kind of architecture.

In this paper, we will focus on the intervention that included the replacement of the glass on the façades, describing those that were the targets, the problems and the solutions. Our work focuses on the large size glass windows that identify the contemporary character of the project

2.2 VISIBLE MODIFICATION

A principle borrowed from the restoration of monuments has been applied to this project as well, the new parts had to be clearly distinguished from the original. All restoration work must be dated, to avoid confusion with the original components. To this end, it is appropriate to provide to the expert eye the chance of recognizing the restoration parts from the original. Usually, when we talk about the restoration of a building, the intent of the designer is to identify the original facies of the building and present it again in the most accurate manner allowed by contemporary techniques.

Although it is not a historical restoration, it was considered important to apply the same principle, being it a building of almost 50 years of age, as a form of respect for the existing building and for the brutalist architecture in vogue in those years.

This conservative approach is undisputed for monuments and buildings which must be preserved for testimonial value and heritage, as required by the rules and regulations regarding the preservation of monuments. For other types of buildings, usually of more recent times, which have a recognized architectural quality there are degrees of wider modifiability. It is a sensitive issue that cannot be defined by rules and which should be left to the architect's project sensitivity.

3 EXPERIMENT / RESEARCH OBJECTIVES

The same or different?

The size of the frames and the glass windows of the façades with high energy efficiency are considerably larger than the ones in use in the '70s, so the repetition of the same design would be impossible. Subsequently, the change of the overall image of the building is a design issue.

The project of the new façade had the following objectives:

- The "all glass effect"
- Improving daylight
- Improving building energy performances
- Foreseeing shading devices
- Preserving the building's soul with a new image, allowing new and old to co-exist.

3.1 THE “ALL GLASS EFFECT”

Our goal was to minimize the perceived dimension of the window frames and to give a new image to the building through a new façade.

The initial idea was to have all-glass; many architects today love this solution, no windows, just glass. The building was supposed to appear made only of reinforced concrete and glass, the contrast between the pre-existing and the new elements. The composition of the building favoured this distinction between the two materials, any large or small openings have a frame of reinforced concrete, which is easily recognizable. Many of the original windows were born to be made of glass only, however, solar control glass was used and in the '70s this meant either mirrored or as in our case, dark brown-coloured glass that absorbs a lot of light. Given the size of about 300cm by 300cm the glass was fixed, while for the opening elements, the surface was instead divided into much smaller portions.



FIG. 3 The “all glass effect”, only reinforced concrete and glass.

3.2 IMPROVING DAYLIGHT

Originally, the building had vertical brise-soleil on part of the glass façade, made up of rectangular section aluminium extrusions. This type of shading is effective when the sunlight is grazing the façade, but does not offer good shading when the sun is perpendicular to the façades; on the other hand, the level of natural lighting inside was very low. The large square windows did not have any shading system, but were made of dark brown glass. Probably the original commercial function of the building presupposed a good artificial lighting in the rooms and brise-soleil had more of an aesthetic function to uniform the façade and therefore bring out the big square windows.

With the new use of the building, the brise-soleil has been removed both to increase the natural lighting and to give a new image to the building.

3.3 IMPROVING BUILDING ENERGY PERFORMANCES

The glass façade is approximately 70% of the vertical shell, therefore, the improvement of the thermal performance is a primary goal. To improve the thermal performance, in addition to using efficient components, in this project the criterion to reduce as much as possible the incidence of the frames on the façades has been adopted. From the thermal point of view, in a glass façade the weak point is usually constituted by the window frames, and although recently there's been considerable improvements, the U_f values are still lower than the U_g of the glass. The reduction of the frames has led to the use of larger glass slabs with consequences in terms of weight, cost and placing which must also be considered.

3.4 FORESEEING SHADING DEVICES

In a building with large windows in Rome, solar radiation is a serious problem. The building is exposed on all sides, but the largest extensions are South-East and West. The request of the property was to avoid external brise-soleil and have a good level of indoor lighting.

4 RESULTS - SOLUTIONS

Our intervention saved, therefore, the building's original design by preserving volumes and materials and, especially, the exposed concrete façades.

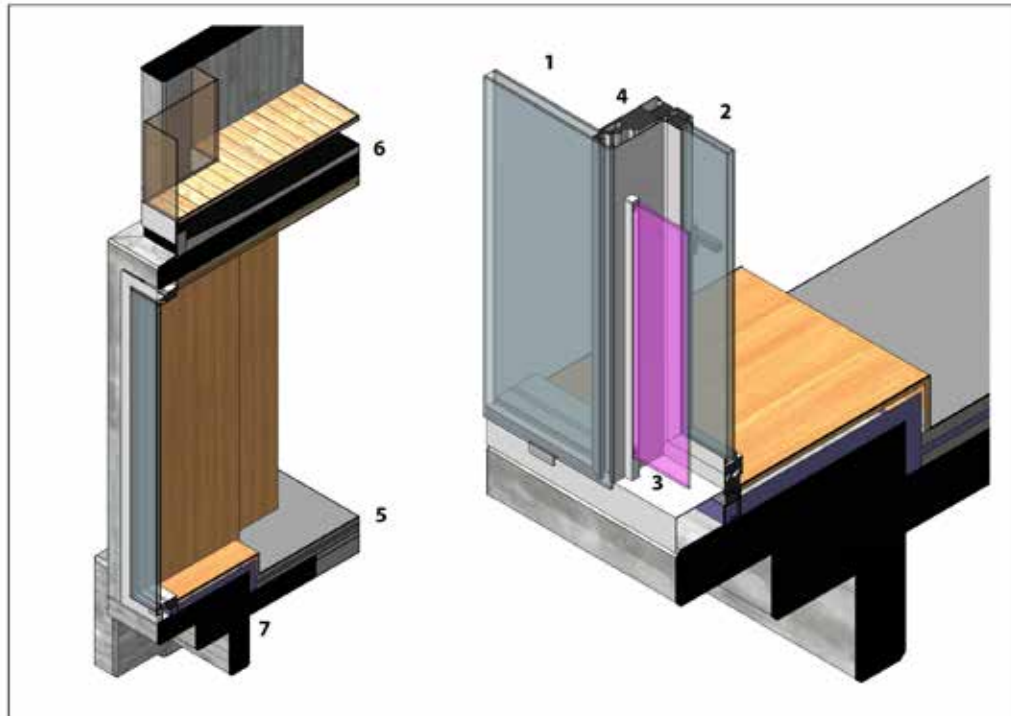

FIG. 4 The part of the façade that can be opened is on a second layer in order to overlap the window frames and to minimize the perceived dimension from the outside. 1-unit system façade, 2-window frame, 3-colored laminated glass balustrade, 4-frames overlapping, 5-floor insulation, 6-ceiling insulation

4.1 A HYBRID SOLUTION WITH UNIT SYSTEM FAÇADE AND WINDOWS

We used unit system technology to cover the window frames from the outside and external glass slabs overlapping the frame to obtain a glass effect for the new façade.

For all the façades, with the exception of those on the second floor, the solution was a hybrid between two technologies used to create glass façades. The fixed windows are panels with structural glass, the ones that open are normal window fittings. The reason for this hybridization can be found in the premise, using as much glass as possible to not see the frames. Unit system technology was created to answer the need to quickly building vast surfaces of curtain-wall on modern skyscrapers. The glass is glued to an external aluminium frame, thus hiding it from view, the set of frame and glass constitutes the element which is assembled in the factory and fixed from the outside to the uprights positioned between the floors. This technology, created to speed up the installation of façades and avoid scaffolding (working only from within) has been used for aesthetic purposes in our project, it has allowed us to assemble large glass slabs up to 350cm by 370cm hiding the frames from sight and thus restoring the image of a continuous glass structure. To further emphasize the image of the all-glass structure, in correspondence of the corners and the openings, the outer slab of the insulating glazing extends between 10 to 15cm beyond the inner slab to cover the risers. The glass is of solar control magnetron type of the thickness of 10t / 27 air / 44.2 b.e.

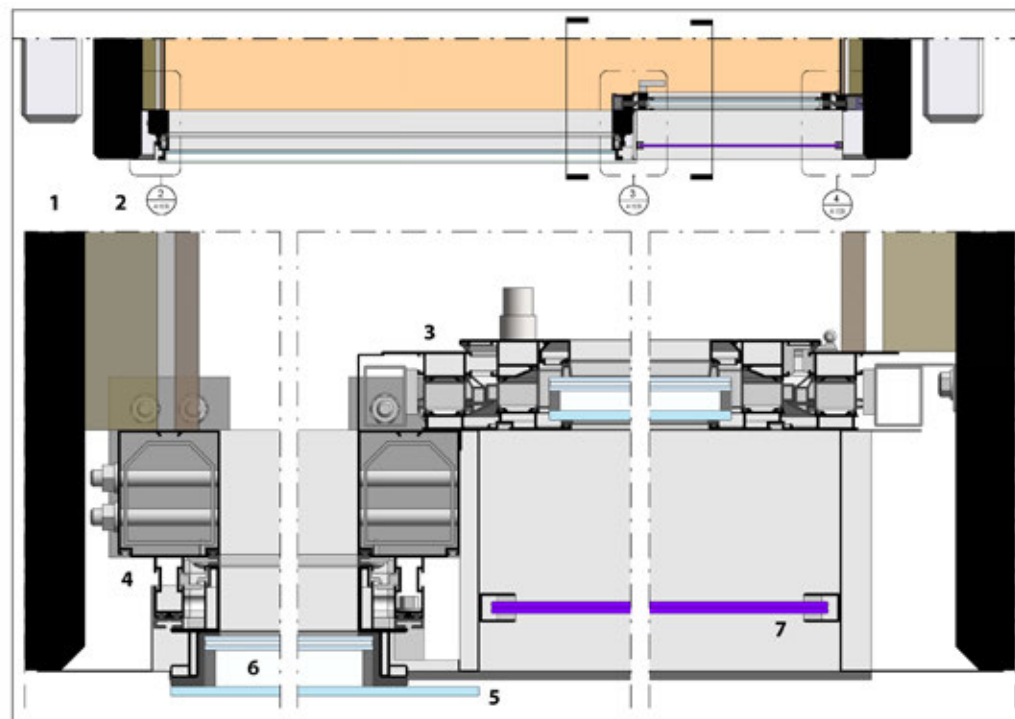

FIG. 5 To reduce the visible part of the outline, the solution has been to overlap the façade glass to the window frame. 1- exposed reinforced concrete, 2- inner thermal insulation with wooden "boiserie", 3- window frame, 4-unit system façade, 5- outer glass extend overlapping the frame, 6- venetian blinds in double glass cavity, 7- colored laminated glass.

The tilt and turn door-windows go from floor to ceiling. They are made of aluminium frames with a thermal cut and have a size of 80cm for a variable height ranging between 290cm and 320cm. The aluminium frames with high thermal and mechanical performances are of considerable thickness, and this contrasts with the design intent of having all glass. To reduce the visible part of the frames, the solution has been to overlap the window frame to that of the façade. Placing the frames next to each other would have meant doubling the thickness, while overlapping them results in only one visible frame. This solution involves a retraction of the window frame in relation to the external thread of the façade and the consequent formation of indentations where the openings are, the balustrade placed on the line of the fixed façade assures the visual continuity of the exterior glass surface. To facilitate ventilation, door-windows have a tilt-turn opening and a gas piston which makes them insensitive to wind blows. Each office has at least one window for natural ventilation.

4.2 HIGH PERFORMANCE GLASS FAÇADE

The U_w value of the original façade was $5.5 \text{ W} / (\text{m}^2.\text{K})$, the new façade has an average value of $U_w = 1.8 \text{ W} / (\text{m}^2.\text{K})$. The focus is on a new high-performance glazed façade with relevant thermal and acoustic performance and with integrated daylight control system devices.



FIG. 6 To further emphasize the image of the all-glass effect at the corners or the openings, the outer slab of the insulating glazing extends 10-15 cm beyond the inner slab to cover the rising.

4.3 GLAZING WITH INTEGRATED BLINDS

The problem of protection from solar radiation in the Ghella office building has been much discussed between the owners and the designers. As often happens, the final solution is a compromise between many instances such as, the image of the building, the energy performance obtainable, the cost, the management and the maintenance. Various solutions have been taken into account and the consequences of each were evaluated;

- external roll-up blinds
- complex maintenance due to atmospheric agents,
- cantilever in screen-print glass,
- effective only when exposed towards South and has an impact on the image of the building,
- reflective glass with high solar factors,
- negative consequences regarding natural illumination and not able to allow thermal radiation benefits during winter.

The chosen solution was to have mobile micro lamellar 12.5 mm thick in micro-perforated aluminium inside the cavity between the two slabs. The reasons for this choice is in the ability to have an adaptive system, protected from the elements, with a low visual impact.

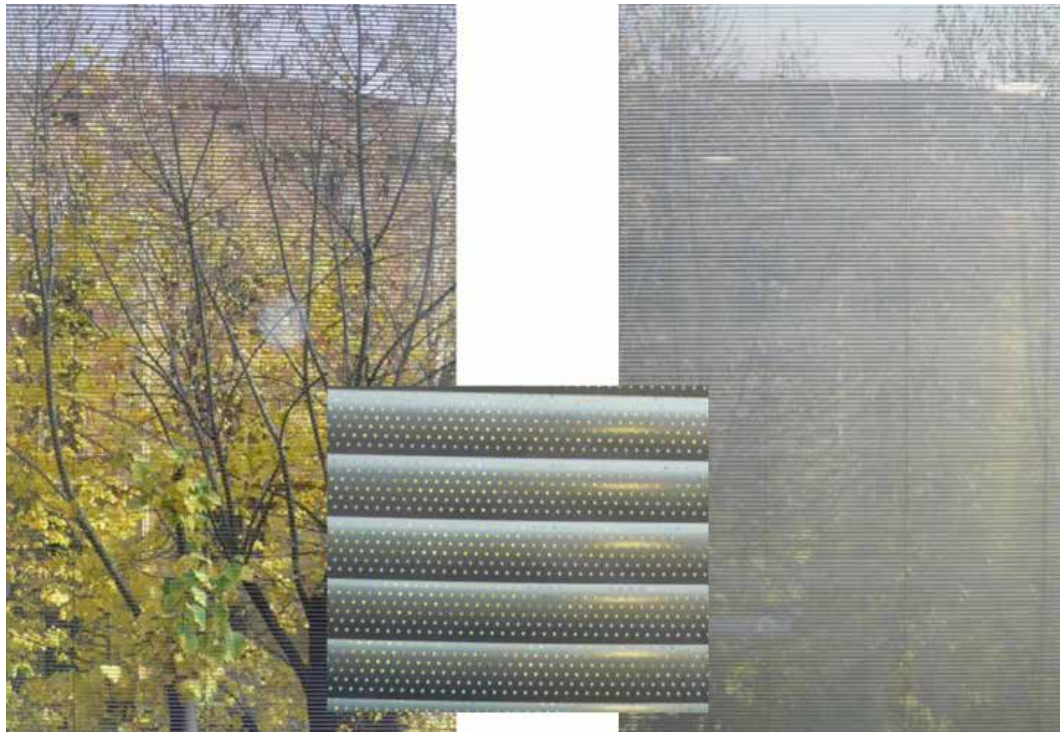

FIG. 7 Mobile micro lamellar venetian blinds with 12.5 mm thick slats , in micro-perforated aluminium, an adaptive system, protected from atmospheric agents, with a low visual impact, which allows the view of the exterior.

Given the size of the cells, some wide up to 3mt, the slats are only adjustable and cannot be raised to guarantee greater durability. The micro-perforation allows, even when the slats are fully closed, a fair perception of the external environment. The slats are controlled by users independently in each room and the only automated system introduced was to close all the plates at night to prevent heat gain the next day if the offices were to remain vacant. This solution has some contraindications, the slats are protected from the elements but are inserted inside a sealed double glazing, which doesn't allow direct access to the slats. In case of any breaks in the mechanisms, the glass must be removed and replaced. At present, about six years from the initial installation, this intervention has not yet been needed for any cell. The second downside is the rise in temperature inside the double-glazing, the radiation is blocked by the slats that hold some of the energy transforming it into heat, the heat contained inside the cavity is retransmitted to the glass that increases its temperature and has a radiating effect towards the interior environment. In essence, the greenhouse effect occurs within the double-glazing unit instead of inside the building. Being substantially radiant energy, it is possible to reduce the discomfort with the use of internal curtain which interrupts the radiation towards the inside.

4.4 DIFFERENTIATED G FACTOR

In this project, we have used glass with different solar factors according to the sun exposure of the individual façades. The project provides a compromise in this case as well, not only between the solar factor and the light transmission, but also amongst the aesthetic needs. In fact, glass with different solar properties have different appearances, differences that are noticeable only if the glass slabs are placed next to each other, otherwise the differences are imperceptible. So, it is possible to use different glass slabs in the same building if one takes care of not placing them next to each other. In this building the task was simple, the façades are very fragmented, more comparable to large windows than to curtain-walls. 4 different glazed areas have been identified:

- Northern surface or completely in shade (loggias on the 2nd floor):
- glass without solar control with $G = 61\%$ and $LT = 69\%$
- Eastern and Western surfaces:
- glass with $G = 41\%$ and $LT = 56\%$
- Southern and horizontal surfaces (connection bridge covering the 4th floor):
- glass with $G = 29\%$ and $LT = 46\%$
- This solution has allowed to reduce the thermal loads from radiation while maintaining a perceptual uniformity of the glass surfaces.

5 CONCLUSIONS

The best performance is not always the best solution. When working on existing buildings that have architectural features to be maintained, the project requires a balance between the numerous instances, where energy efficiency is the primary goal but must not overpower the aim of preserving the building or at least its main features. The level of efficiency that results cannot therefore be compared to that attained by a new building. The proposed design is therefore suggested as an example of this type of approach by proposing solutions for improvement. Something that comes close to the concept of "integrated conservation" used for restoration, finding the right compromise between the needs of conservation and those of energy efficiency. Specifically, in the case exposed, the new project of the glass façade is carrier of a new contemporary image of the building, which we believe enhances and rejuvenates this rare example of Roman brutalist architecture.

References

- Clemens R., Schulz C. (2013). Energy efficiency refurbishments. Munich: Detail Green Books
- Knaack, U., Klein, T., Bilow, M., & Auer, T. (2014). façades, Principles of construction. Basel: Birkhäuser Verlag GmbH.
- Rossi, P. (2009) Alvaro Ciaramaglia Architetture Romane, Roma: Prospettive Edizioni
- Carta della Qualità della Città di Roma: <http://www.urbanistica.comune.roma.it/prg-struttura/prg-struttura-gestionali/prg-struttura-gestionali-cpq.html>
- Troi, A.; Zeno, B. (2015). Energy efficiency solution for historic buildings, Basel: Birkhauser Verlag GmbH

Variable Façade – Method to apply a dynamic façade solution in Santiago, Chile

Claudio Vásquez¹, Renato D'Alençon²

- 1 Escuela de Arquitectura P. Universidad Católica de Chile, El Comendador 1916, C.P. 7520245 Providencia, Santiago de Chile, tel. +56.2.2354.5611 clvasque@uc.cl
- 2 Escuela de Arquitectura P. Universidad Católica de Chile, El Comendador 1916, C.P. 7520245 Providencia, Santiago de Chile, tel. +56.2.2354.5613, dalencon@uc.cl

Abstract

Sun exposure is a variable phenomenon that forces to conceive building façades as an architectural component that must vary accordingly. On this premise several concepts have been developed that aim to give a dynamic character to the interior-exterior relationship that façades must mediate. In this line, the concept of a Variable Façade is proposed, which corresponds to the application of these ideas in the Chilean context, where the technological and industrial realities do not allow to think of motorization as a unique market solution for variability. Variable Façade is a technical and architectural design concept that ranges from the absence of sun protection to fixed and mobile, mechanized solutions, applied in the control of sun radiation and light transmission with the objective of reaching the best balance between energy performance and environmental comfort for the users of the buildings. The development of this concept is proposed through the combination of 1:5 scale prototype measurement campaigns and simulation processes to bring the experimental results to annual performance analysis. This methodology is proposed as an approach being compatible with the iterations of the architectural design, since it allows to test a greater number of options, avoiding in the prototypes most of the construction variables that the 1: 1 scale forces to solve. We present in this paper the Laboratory of Sun Protections, LAPSO (Spanish acronym for Laboratorio de Protecciones Solares) a measurement platform that will allow the development of the concept of Variable Façade., initial submissions should fulfil the final layout assuming that no revisions shall be necessary.

Keywords

façade, adaption, laboratory, scale, testing

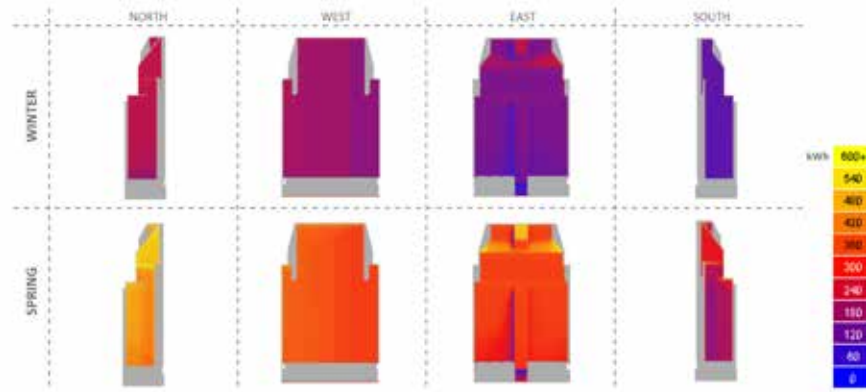

FIG. 1 Seasonal Comparison of the sun radiation exposure on the facade of an office building in Santiago. Drawing by Alejandro Prieto.

1 INTRODUCTION

Exposure to daylight and solar radiation in buildings is not constant: it varies with height, orientation and daytime, especially in urban situations. To illustrate the problem, Figure 1 shows the annual insolation of a typical Santiago office building and it is possible to see the variations between the different orientations and seasons of the year. Therefore, for optimum performance the solution of the façades cannot be uniform, but should vary according to the situation it faces.

On the other hand, the use of sun protections can be transformed into another problem if applied without considering their operating conditions in relation to the simultaneous control of sun radiation and illumination, which do not function in a correlative way, e.g. more illumination leads to generates excess radiation and vice versa. To illustrate this, the sun radiation and daylighting transmission of two prototypes oriented to the north in a clear day are presented in the graphs below (Fig. 2): a fully glazed façade (left) and a glass façade with fixed horizontal louvers as sun protection (right). Measurements were performed on a 1:5 laboratory probe, where sun radiation on the (interior and exterior) glass surface and horizontal illuminance (inside the façade, deep inside and outside) were measured.

The graph for the unprotected façade (Fig. 2 left) shows the coupling that occurs between the illuminance and the solar radiation in the area close to the façade reaching their peak levels at midday and declining during the morning and into the afternoon, following the sun position. Meanwhile, at the back of the room, the daylighting is negligible, contrary to what happens close to the façade, very likely indicating a significant glare. Such coupling of illuminance and radiation can be considered a problem since it involves high indoor temperatures, high levels of glare and low illuminance in the background, set of conditions that describe problems of visual and thermal comfort in the interior space and an inefficient use of energy, by the demands associated with air conditioning and artificial lighting.

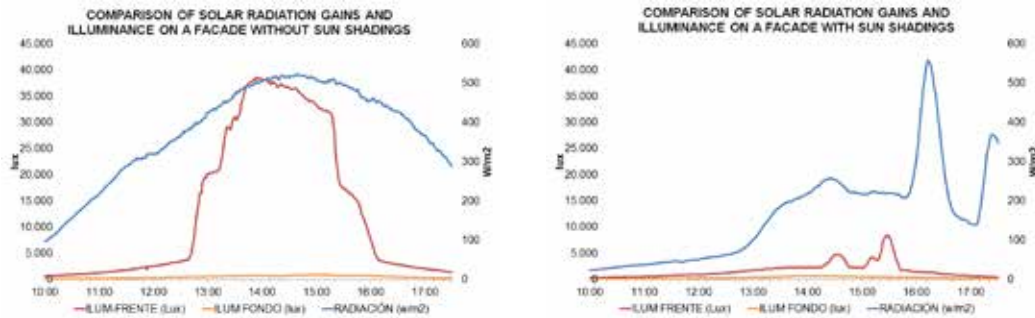

FIG. 2 Sun radiation and daylighting transmission of two prototypes oriented to the north in a clear day without (l.) and with (r) sun protections.

2 DECOUPLING OF RADIATION AND LIGHTING

A specific problem is the coupling of the radiation heat gains and natural lighting and its correlation with the solar path in buildings with predominantly glass façades. The cause is that both types of gains are proportional to sun radiation passing through the façade. This is not compatible with the simultaneous requirements of thermal and visual comfort of users or with reasonable energy consumption. The graph for the façade without sun protections screen (Fig. 2 right) shows that when a sun protection is used, daylighting and solar radiation are decoupled, ceasing to exist a direct correlation with the energy and light gains and the sun position. At the same time, daylighting in the back of the rooms is maintained in levels absolutely disparate when compared with the area close to the façade, so the problems of visual discomfort persist. This decoupling and persistence indicate that sun radiation heat gains and daylighting can be dealt with as separate phenomena, and suggests an opportunity to think about the design of sun protections that work with both decoupled but coordinated radiation and daylighting to optimize the conditions of thermal and visual comfort, minimizing energy demands for air conditioning and artificial lighting.

The graphs below (Fig. 3) show the comparison between horizontal lattice protections, fixed and mobile, both wooden, geometrically identical, oriented north and were measured during the same summer day in Santiago, Chile. The movement pattern in this case consists in the louvers turning around their own axis to open or close to sun beams according to the intensity of sun radiation, which was registered by a pyranometer located outside, parallel to the façade. When fully open, the louver position is perfectly horizontal, equivalent to 0°, and when closed perfectly vertical, 90°. The electric servo drive was controlled by an Arduino electronic board that set the blinds to take the 0° position when the pyranometer reads 0 W/m² and 90° when it reads 400 W/m².

The upper graph (Fig. 3 left) represents in red the sun transmission of a fixed louver protection and the blue represents a mobile protection, moving according to the described pattern. It is significant that around noon, when the horizontal louvers work efficiently, sun radiation transmitted by the mobile louvers is almost half of that transmitted by fixed louvers, which should result in a significant decrease in energy consumption for cooling in summer.

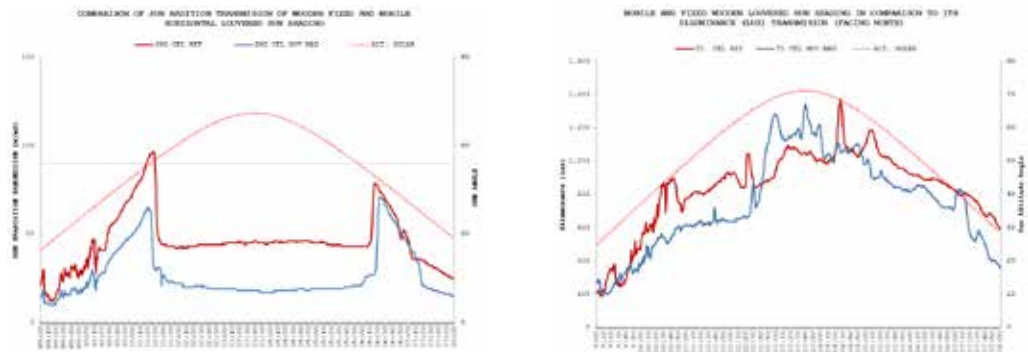

FIG. 3 Left: Sun radiation transmission (W/m2) in a day cycle for a wooden horizontal lattice, fixed (red) and mobile (blue); Right: illuminance (lux) in a day cycle for a wooden horizontal lattice, fixed (red) and mobile (blue)

The second graph (Fig. 3 center) shows what happens to the illuminance on the periphery of the rooms, close to the façade during the day. It is noticeable that the situation of both louvered protections is very similar: from 10 a.m. illuminances range between 500 and 1200 lux, acceptable for office activities. It is important to keep in mind that this movement pattern was activated only by sun radiation, i.e. it does not respond to the availability of natural light, so it would be possible to still improve the lighting performance of the mobile louvers by activating a lighting (illuminance) optimized pattern.

The third graph (Fig. 3 right) shows the effect of the lighting movement pattern in the back of the room, some 6 to 8 m away from the façade. Illuminance is compared in terms of light transmission factor, a critical indicator in this area of a plan. In red, the fixed lattice shows that the illuminance never reached 150 lux, and light transmission ratios did not exceed 3%. However, the mobile lattice reached values between 50 and 250 lux with ratios reaching almost 5%. Although the result is not optimal, this analysis shows that the movement achieves better results in lighting the back of a room, although in this case the movement pattern was sun radiation, as we have explained.

3 STATE-OF-THE-ART

A recent general definition that meets the above is the one proposed by Loonen et al in his article "Climate adaptive building shells: State-of-the-art and future challenges" (Loonen et al, 2013), focused on the application of what the authors call Climate Adaptive Buildings Shells, CABS, to achieve the highest levels of performance. Compared to conventional facades, CABS offer potential opportunities for energy savings, better indoor environmental quality, combining active and passive technologies in the building envelope. According to the conclusion of Loonen et al, these concepts cannot yet be considered mature and future research areas are identified and in particular the new challenges facing the researchers in this specific field.

Diverse concepts have been associated with such solutions, known as Active Façades (XU et al., 2008) or Adaptive and Responsive Façades, ARF (Wigginton, 2002; Knaack, 2007) defined as those which have the ability to adapt or respond to environmental conditions or use. The common vision of these systems, also generally known as Intelligent Façades (Compagno, 2002), is the conception and design of the façade system as an active entity linking with the outside, under the logic that if the external conditions to which a façade system faces vary, the building should vary likewise.

Recent research has shown that the automation of facades leads to improvement in the interior lighting conditions (Mettamant et al, 2014) particularly by algorithms or control patterns in greenhouses (Bastien and Athienitis, 2011) and in façade systems applied to buildings (Aste et al, 2012). These studies have shown that sun protections movement optimizes the quality of the indoor environment and associated energy consumption. This is especially important in buildings in the tertiary sector where internal loads are high and constant during daylight hours.

Although it has already been stated that the variability of the façade system is a suitable solution to respond to sun trajectory, the coordination of parallel movements that simultaneously respond to illumination and sun radiation is an unexplored field that has no solutions at the technological level. Favoino et al (2014), and others in the field of design and development, have proposed a new approach to the development of new technologies, by means of a method to define the ideal / optimum range of adaptive thermo-optical performance of a glass façade with different reaction times, in order to evaluate the potential of future adaptive glass façades. Among the existing studies, some focus on built-in solutions and prototypes, such as ACTRESS (ACTive, RESponsive and Solar Façade), or user interaction in control systems (Favoino et al, 2016). Goia and Cascone (2014), on the other hand, present the results of an investigation to evaluate the advantages of an ideal adaptive building skin based on the systems of construction of conventional claddings.

These investigations show the expected advantages, but do not address specific solutions or strategies for this problem, which is what we propose to develop in this work. All of these studies, one way or the other, coincide in the importance of coordinating in the architectural design the multiple possibilities of these technologies in order to make them effective or even possible. This poses a specific challenge for architects as it involves the role of the discipline as a coordinating actor in the design process. From this point of view, a decisive variable is the viability that principles elaborated at a scientific level have in a specific market and their relation with the technological reality of the building industry.

4 THE CHILEAN CONTEXT

The fundamental objective of this work is to address this perspective, which involves approaching the scientific problem and its specific feasibility in the context of a less developed, but steadily growing country like Chile. Another reason to investigate this particular case is the climate of Santiago, the capital of the country, located in a region with a prevailing cool semi-arid climate (BSk according to the Köppen climate classification), with Mediterranean (Csb) patterns. Our previous studies have focused on establishing for the Chilean case the correlation between the transparent area of the façade and the energy consumption of buildings and on establishing levels of thermal comfort of people working in them (Vásquez et al, 2015). Regarding lighting comfort, we have established as main problems glare in areas near the façades and low lighting in the back of the rooms. These lead users to block the light from the outside, and to use artificial lighting during the day. At the same time, we have established that the correlation between the transparent surface and the energy consumption of these buildings reaches R2 value of 0.97 in summer. We know that in summer curtain walls office buildings completely fail to meet the thermal comfort of users for 55-60% of the working day and come to reasonable availability of natural light in a 22-25% of the year. These results rise the investments in energy for lighting and air conditioning, and directly affect labor productivity.

On the other hand, we have also been able to establish the availability of more than 745,000 m² of façades that could use sun protections to improve performance in over 2,000,000 m² of office area, considering buildings with permission or final approval in the 2005-2013 period only. The use of some sunscreen reaches only 27% of built stock of office buildings, but their application does not lead to the best performance of the buildings that have them, indicating that that sun protections are rarely used and when applied they are not correctly used. Both buildings now in operation and those that are still being designed and built with the same criteria, represent an opportunity to improve both comfort and energy performance through variation of sun protections depending on solar radiation and daylighting as independent phenomena juxtaposed in one system solution.

The need to scientifically address the problem is associated with the need to establish experimentally the potential and limitations that the decoupling of radiation and lighting performances have. The international state of the art on the subject suggests that mobile sun protections are the best solution to solve the problem we face, however this must be proven by experiment before being technologically developed in Chile.

4.1 VARIABLE FAÇADES IN CHILE

In Chile, the possibility of using dynamic sun protections is available in the market by means of several products offered by the company Hunter Douglas. These solutions for façade adaptability that have been applied in a few buildings currently in operation. However, the emphasis of these products is on responding to an automated movement patterns, not to the conditioning of an inner space with specific environmental qualities. The development of this concept, associated with multiple patterns determined by more than one type of external stimulus, such as radiation and natural light, for example, has not yet been developed or implemented. In Chile, there are two buildings that apply a variable position system, consisting of outdoor roller blinds, they are:



FIG. 4 Transoceánica Building, + Architects. Santiago de Chile (2010). Photograph: + arquitectos

Transoceánica Building, + Architects (Fig. 4): includes is a solution that combines static and dynamic solutions juxtaposed to the way this project proposes, that is: a roll-up curtain system that is driven by direct solar radiation, detected by a mini meteorological station located on the roof of the building. The fixed sun protection is a wooden grid that complements the work of the curtain. The system was installed and is maintained by an external company that is responsible for its operation.

ITAU building, designed by Estudio Leyton Architects, (Fig. 5) is the first LEED-certified corporate building built in Chile and has an automated external curtain that is part of a centralized system of environmental management of the building. The curtains are also activated by the presence of sun radiation.

These cases are important innovations in Chile and show that there is a need to develop solutions that consider the use of mobile systems driven by climatic factors. However, in these cases movement patterns focus exclusively on blocking radiation in binary form; they only have two positions: open or closed, without intermediate adjustments. Moreover, in both the lighting depends on the weft of the fabric of the curtains, and the lighting in the back of the room plan is not resolved, and the illuminance or the contrast on the front (close to the façade) is also not assured. In the Chilean market for sun protection systems, the existing available solutions are exterior roller shades, of the kind applied in the previous cases, awnings and various mobile louvered blinds solutions. Automation is an added value that depends on the project and its application is not associated with an optimized or juxtaposed movement pattern. These solutions could be further improved by considering sun radiation and lighting as problems that must be addressed independently and coordinated for optimal system performance of the façade.



FIG. 5 ITAU Bank Building, Estudio Leyton, Architects. Santiago de Chile (2009). Photograph: Google Streetview

In this technological and commercial context, the contribution of this project will be the introduction of juxtaposed movement patterns able to coordinate sun lighting and solar (radiation) gains in buildings, an unexplored field in which there are no technological solutions in Chile or abroad meeting Chilean construction standards and market conditions. The solution to this problem should then focus on simple innovative, using simple movement patterns typical of the solutions now applied in Chile, yet juxtaposition patterns will add attributes that should make the solution be considered as a variable form solution. The use of simple movement patterns will ensure that major components and system parts, such as motors and mechanical parts, are packable and readily available in the market following an analysis of specific requirements. At the level of technological development are two fundamental challenges: the measurement, processing and transmission of the information to the actuators, which will require an especially developed computer system; and the design of movement patterns, on which the current scientific research is focused.

5 VARIABLE FAÇADE

Evidence both in the available literature and our own experimental experience (figs. 2 and 3) shows that mobile sun protections are capable of improving the energy performance relative to static systems. The possible options for change include: no protection, the use of fixed shadings and the use of a mechanically adjusted sun protection system based on patterns associated with variations in sun radiation and sun light. The latter is the center of innovation of this project. Internationally, existing mobile facades solutions can be divided into two groups:

- Variable Form Systems: consist of solutions where sun protections are deformed and then return to the original shape, either by the action of a mechanical folding mechanism, by deformation of a flexible material or by the use of pneumatic structures. They characteristically need to solve complex mechanics, with an emphasis on a form responding to the deformation itself, and not to an external pattern. They are complex in their design and difficult to apply as standardized solutions.
- Variable Position Systems: consist of solutions where sun protection is not deformed but is shifted maintaining its form. According to the movement, they can be of stepper movement, rotate around an axis, or overlap layers. Such solutions are characterized by the simplicity and regularity of its mechanical systems and are found more often in architecture solutions.

This discussion, as well as the literature review show that adjustment through motion improves the performance of a sun protection. However, it is still unclear under what conditions their use is feasible in relation to a static solution. Thus, it is necessary to undertake a process of experimental research to answer the following questions:

- Under what conditions does the movement of a sun protection acquire comparative advantages over the same static solution?
- What movement patterns are suitable for independently optimizing day lighting and radiation gains performance of a mobile lattice?
- What relationship can be established between the daylighting pattern and the radiation gains pattern and what limitations on the performance of each would the juxtaposition of both impose?
- What materials are suitable for sunlight protection and radiation gains protection for the climate and environmental context of the city of Santiago?

Answering these questions will allow us to develop the concept of Variable Façade, which means the adaptation of findings made at the scientific level to the reality of a façade technology in a specific market segment with little development.

6 SUN SHADING LAB – LAPSO (LABORATORIO DE PROTECCIONES SOLARES)

In order to address these questions, a method has been organized based on computer models and scaled prototypes. Computer models are used to define solutions by defining relevant parameters, iterating the models and selecting the optimum solutions by means of a multiple-variable selection method. Scaled prototypes are used to test under real conditions the solutions previously selected; these allow for an easier construction of the samples (as opposed to full-scaled mockups) and do not compromise the results of illuminance and sun radiation measurements; however, they do not deliver relevant results in temperature or energy consumption, and are thus limited to calibration of computer models in specific, relevant results.

The process is divided into three stages: (1) Definition and construction of sun protection prototypes, which consists of searching for optimized solutions for the three types of solar protection (screen, horizontal louvers and vertical louvers), types of performance (radiation and illuminance) and variation (fixed and mobile); (2) Experimental measurements, which consists of measuring the performance of sun protections in the laboratory; (3) Extrapolation of results, which consists of the calibration of a model that allows extrapolating the experimental results to their energy performance. This article reports the first stage, which is highlighted in a box, as it represents the sustained progress at the current stage, and it is shown in the chart (fig. 6).



FIG. 6 Work method divided into three stages: (1) Definition and construction of sun protection prototypes; (2) Experimental measurements; and (3) Extrapolation of results

Phase (1) consists of the definition and construction of prototype and the obtained results are differentiated from the type of sun protection and are described in the following table (Table 1).

HORIZONTAL LOUVER														
GEOMETRIC PARAMETERS				PERFORMANCE ANALYSIS				MECHANICAL ANALYSIS			VISIBILITY ANALYSIS		BENCHMARKING	
NOMENCLATURE		WIDTH (m)	INCLINATION ANGLE	SPACING (m)	CURVATURE RADIO (m)	ANNUAL UDI (%)	ANNUAL THERMAL COMFORT (%)	ANNUAL ENERGY (kWh/m2)	SOLAR GAINS (kWh/m2)	TOTAL WEIGHT (kg)	SIGMA	INERTIA	VISIBILITY (%)	SCORE
FIXED	C_HOR_FU_41	0.3000	42,5000	0.2700	0.8900	71,5000	80,1000	58,7000	748,3000	0,0000	2308,2000	0,0040	39,6000	1,0000
MOBILE BY RADIATION	C_HOR_MRAD_21	0.2500	-	0.2650	0.7810	80,7000	89,4000	58,4000	957,2000	0,3000	2918,0000	0,0026	44,0000	1,0000
MOBILE BY ILLUMINANCE	C_HOR_MLUX_24	0.2250	-	0.2250	0.7000	80,7000	88,8000	54,2000	724,1244	0,3000	3242,2000	0,0021	0,5400	0,9800

VERTICAL LOUVER													
GEOMETRIC PARAMETERS				PERFORMANCE ANALYSIS				MECHANICAL ANALYSIS			VISIBILITY ANALYSIS		BENCHMARKING
NOMENCLATURE		WIDTH (m)	INCLINATION ANGLE	SPACING (m)	ANNUAL UDI (%)	ANNUAL THERMAL COMFORT (%)	ANNUAL ENERGY (kWh/m2)	SOLAR GAINS (kWh/m2)	TOTAL WEIGHT (kg)	SIGMA	INERTIA	VISIBILITY (%)	SCORE
FIXED	C_VER_FU_42	0.1880	-42,5000	0.1410	65,7000	92,7000	75,1000	1901,1000	0,5000	94,1000	0,0005	36,2000	1,0000
MOBILE BY RADIATION	C_VER_MRAD_30	0.2120	-	0.1350	75,5000	90,3000	63,2000	1226,6000	0,5000	94,1000	0,0008	47,4000	1,0000
MOBILE BY ILLUMINANCE	C_VER_MLUX_79	0.4750	-	0.2370	80,2000	89,2000	57,9000	897,5000	1,3000	94,1000	0,0089	0,6500	1,0000

SCREEN													
GEOMETRIC PARAMETERS		PERFORMANCE ANALYSIS				MECHANICAL ANALYSIS			VISIBILITY ANALYSIS		BENCHMARKING		
NOMENCLATURE		TRANSPARENCIA (%)		ANNUAL UDI (%)	ANNUAL THERMAL COMFORT (%)	ANNUAL ENERGY (kWh/m2)	SOLAR GAINS (kWh/m2)	HIGHER RIGIDITY	HIGHER LKGF/WEDGE	LOWER AERODYNA MICLOAD	VISIBILITY (%)	SCORE	
FIXED	C_PAN_FU_07	25%		70,7500	92,0667	71,1889	1620,6795	4,0000	6,0000	6,0000	25,0000	1,0000	
MOBILE BY RADIATION	C_PAN_MRAD_08	42%-42%		76,7500	90,4737	63,3532	1246,9322	1,0000	47,0000	51,0000	27,3512	1,0000	
MOBILE BY ILLUMINANCE	C_PAN_MLUX_02	8%-40%		67,7500	89,5738	60,3772	1041,0370	1,0000	1,0000	17,0000	27,0000	1,0000	

TABLE 1 Definition of prototypes differentiating the type of sun protection

In order to test the concept of Variable Façade, four test chambers were built in a scale of 1:5 to collect the sun radiation and light performance data of three parallel façade system prototypes plus a control chamber, which make up the main component of the research laboratory. Because of the scale, these chambers have the restriction of not representing the phenomena of heat transfer, however they do have the ability to represent the solar and light gains that this project requires. The boxes are built with 50mm thick walls made of metal faces and high density polyurethane infill, and are shown in the drawings below (Fig. 8).

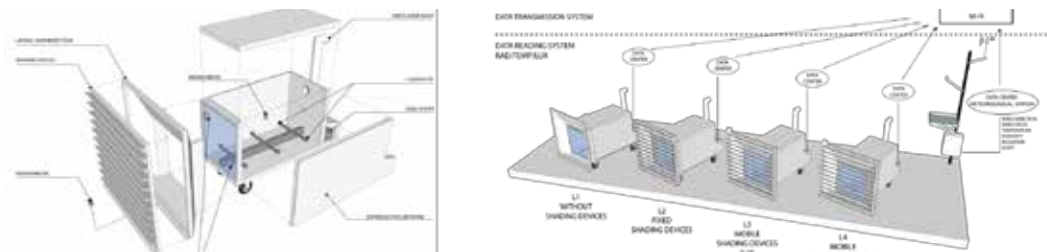

FIG. 7 Diagram showing the parts of the test chambers (top left) and layout of four chamber, three for testing sun protections plus one control chamber on the test platform (top right) and image of the built chambers (bottom)

The chambers are opaque in five faces and the sixth is a window that occupies the entire front, representing a fully glazed façade system. Parallel to the transparent face, a substructure is placed that allows to install prototypes of exterior sun protections. The upper cover of the chambers can be opened to allow access to the main space where the internal measurements are made and to install the sensors that will make the readings of the parameters to be registered. Each chamber also has a compartment in its back to install the electronic system collecting and sending data. In addition, the chambers are equipped with air extractors to control temperature excess that might affect the instruments in the interior and are wheeled to facilitate their transport and exact location. The measurements conducted in the chambers are the following:

- Sun radiation: the pyranometers are located both directly on the interior face of the façade to measure the transmitted solar energy, and on the outside, to measure the solar gain index. For this calculation surface thermometers are also used that allow to evaluate the energy re-irradiated by the glass. Measurements are made every minute so that a detailed radiation curve is obtained.
- Illuminance: three luxometers are arranged in line to evaluate the light gradient generated by the sun protection. In addition, a luxometer is placed on the outside to calculate the rate of light transmission, both at the front and at the back of the box. Also, at the rear of the box a camera slot is available that allows to make HDR images that are then taken to a false color analysis to evaluate the luminance levels of the sun protection. Measurements are also performed minute by minute.

The results obtained are used to generate a database that allows the construction of the energy extrapolation model and the quality of the interior environment, which will then allow to calibrate the results of the models and optimize the performance of the sun protections.

7 CONCLUSION

The objective of this article is to introduce the early stages of the development of the concept of Variable Façade, which should be understood as the adaptation of the different concepts associated with the reactivity of the façade systems in a particular social and economic context such as the Chilean one. LAPSO, Laboratory of Solar Façade Protections is introduced: a measurement facility that will allow the development of this concept based on a methodology that combines 1:5 scale prototyping with modeling to obtain projected data for the complete year cycle. Preliminary results show that, at the typological level, the best sun protection solution is not the same if the goal is to optimize solar performance, light or both at the same time. LAPSO will allow the comparison of these three options aiming to characterize the de-coupled behavior of the illumination and the solar radiation and then manipulate them in a juxtaposed way to obtain the best combination of solar, energetic and luminous performance.

Acknowledgements

This research has been conducted with funding from the National Council of Scientific and Technological Research of Chile (CONICYT) through FONDEF IDEA ID15110425 "FACHADA VARIABLE: Solución de fachada dinámica en base a patrones de movimiento coordinados para el control solar y lumínico aplicable en Santiago de Chile".

References

- Aste, Niccolò, Rajendra Singh Adhikari, and Claudio Del Pero. "An Algorithm for Designing Dynamic Solar Shading System." *Solar Energy* 30 (2012): 1079–89.
- Bastien, D., and A. K. Athienitis. 'Control Strategy for Thermal Screens in Greenhouses: An Algorithm Based on Heat Balance'. In *International Symposium on Advanced Technologies and Management Towards Sustainable Greenhouse Ecosystems: Greensys2011* 952, 501–7, 2011.

- Favoino, Fabio, Qian Jin, and Mauro Overend. 'Towards an Ideal Adaptive Glazed Façade for Office Buildings'. *Energy Procedia* 62 (2014): 289–98.
- Favoino, Fabio, Francesco Goia, Marco Perino, and Valentina Serra. 'Experimental Analysis of the Energy Performance of an ACTIVE, RESponsive and Solar (ACTRESS) Faccade Module'. *Solar Energy* 133 (August 2016): 226–248.
- Goia, Francesco, and Ylenia Cascone. 'The Impact of an Ideal Dynamic Building Envelope on the Energy Performance of Low Energy Office Buildings'. *Energy Procedia* 58 (2014): 185–92.
- Knaack, Ulrich, Tillmann Klein, Marcel Bilow, and Thomas Auer. *Façades: Principles of Construction*. 1st ed. Birkhäuser Basel, 2007.
- Loonen, R. C. G. M., M. Trčka, D. Cóstola, and J. L. M. Hensen. 'Climate Adaptive Building Shells: State-of-the-Art and Future Challenges'. *Renewable and Sustainable Energy Reviews* 25 (September 2013): 483–93.
- Mettanant, Vichuda, and Pipat Chaiwiwatworakul. "Automated Vertical Blinds for Daylighting in Tropical Region." *Energy Procedia* 52 (2014): 278–86.
- Vásquez, Claudio, Felipe Encinas, and Renato D'Alençon. 'Edificios de Oficinas En Santiago: ¿Qué Estamos Haciendo Desde El Punto de Vista Del Consumo Energético?' *ARQ* (Santiago), no. 89 (April 2015): 50–61.
- Wigginton, Michael, and Jude Harris. *Intelligent Skins*. Oxford [u.a.]: Butterworth-Heinemann, 2002.
- Xu, Xu, and Steven Van Dessel. "Evaluation of a prototype Active Building Envelope Window-System." *Energy and Buildings* 40, no. 2 (2008): 168–74.

Integration of technology components in cladding systems

Philipp Molter¹, Tina Wolf², Michael Reifer³, Thomas Auer⁴

- 1 Philipp Lionel Molter, Technische Universität München, Department of Architecture, Associate Professorship of Architectural Design and Building Envelope, Arcisstraße 21, 80333 München, Tel: + 49 89 289 28462, philipp.molter@tum.de
- 2 Tina Wolf, Technische Universität München, Department of Architecture, Associate Professorship of Architectural Design and Building Envelope, Arcisstraße 21, 80333 München, Tel: + 49 89 289 28699, tina.wolf@tum.de
- 3 Michael Reifer, Frener und Reifer, Via Alfred Ammon Straße 31, 39042 Bressanone, Tel. +39 0472 270158, m.reifer@frener-reifer.com
- 4 Thomas Auer, Technische Universität München, Chair of Building Technology and Climate Responsive Design, Arcisstraße 21, 80333 München, T: +49 89 289-23815, F: +49 89 289-2385, klima@lrz.tum.de

Abstract

This paper presents an evaluation of unitized façade systems integrating energy harvesting devices and their synergetic potential to improve internal thermal as well as visual comfort. Today's cladding systems for contemporary office buildings are divided in two different design approaches: For the premium market segment, mostly bespoke solutions are designed to meet the architects design intent. But for more than 90 per cent of Europe's building market, performance needs to match a certain price range (Construction Perspectives and Oxford Economics 2011). In the last years, several ready designed 'façade products' have been offered by façade companies integrating energy harvesting components, natural as well as decentralized mechanical ventilation components and sun shading devices. The integration of energy harvesting devices as well as technical devices to improve internal comfort conditions have a major impact on thermal and visual performances of a façade design. Most devices to improve internal comfort are opaque and reduce solar gains but also the level of natural light in the internal spaces. This opacity also obstructs direct views of users. Some devices are translucent and can act as sun shading device or even regulate daylight by redirecting direct radiation towards internal spaces. Key aspect of this work is the dichotomy of diverse requirements of a modern building envelope in a tangible integration of technical components in a unitized cladding system. This paper focuses on an exemplary integration of an energy harvesting element using solar thermal components in a fully glazed office façade investigating to what extent active solar façade components can be synergistic to provide visual and thermal user comfort. Interior illumination levels and the potential of the energy harvesting façade as a sun shading device are evaluated in an in situ test cell at the Technical University of Munich and are majorly taken from a PhD thesis "Integration of technology in open cladding systems: Design and development of a multifunctional façade module focusing on the evaluation of a case study in a holistic context."

Keywords

façade, technology integration, energy harvesting, design strategy for office facades, daylight in office buildings, solar thermal facades energy harvesting building envelope,

1 INTRODUCTION

Today's office buildings are aiming for ambitious reduction of energy consumption. However, a comparison of the typically consumption of primary energy ratings for office buildings shows the impact of this building typology in regards to its use of energy. The following numbers reveal electricity consumption for building services systems as well as lighting and energy for heating (Pfafferott, J., & Kalz, D. 2007):

- air-conditioned buildings (existing building): 654 kWh/m²
- average office building (air-conditioned and non air-conditioned, existing building): 424 kWh/m²
- new office buildings and (standard segment): 200 kWh/m²
- optimized office buildings 100 kWh/m²

The predominant cause for the above mentioned energy consumption is the provision of comfort of interior spaces. However, the building envelope serves as an interface between the inside and outside and filters or absorbs physical Energy flows towards the interior of a building. The 'comfort' depends on personal perceptions and also on temporarily changing feelings of an individual user. It mainly consists of four comfort parameters:

- visual comfort
- thermal comfort
- acoustic comfort
- supply of fresh air

Those four comfort parameters are essential for human well-being and human performance. The regulation of those parameters define also the Energy performance of a building.

Visual comfort: The visual comfort defines the conditions of the human environment in terms of lighting levels, glare, light distribution and light color. For the users the main aspects of visual comfort are:

- the comfort of human beings that provides the feeling of well-being
- the performance which enables working people to manage visual tasks even under difficult circumstances over a long time period.

However, adequate supply of daylight is a very important component for human health and therefore the building envelope needs to provide precise regulation of glare, illuminance, brightness, luminous flux. This can basically be achieved by a kinetic change of a translucent or opaque material, blocking or redirecting daylight into the building. In building envelopes, this means glare control textiles, light shelves, (venetian) blinds. (Cremers, J. 2015)

Thermal comfort: Thermal comfort is very much related to the air temperature as well surface temperature of our human body. It is further depending on physical activity, age, gender, surface temperatures, humidity, air speed and insulation between human body and surrounding space. Most of these parameters are significantly driven by the performance of the building envelope by Sun shading devices, thermal insulation materials, radiation reflecting or absorbing materials. (ASHRAE Standard 1981)

Acoustic comfort: just as the regulation of the above mentioned parameters, acoustic comfort ensures performance and well-being of our internal spaces. "Acoustic comfort" is achieved when the workplace provides appropriate acoustical support for interaction, confidentiality, and concentrative work by regulating noise levels, sound absorption, sound attenuation, sound insulation and reverberation time. The building envelope provides mostly high sound insulation from exterior to the interior of a building by using sound absorbing surface towards interior spaces.

Fresh air supply: besides human emissions of CO₂ and humidity, gases, odours, biological impurities that transmit diseases, aerosols and dust require sufficient amount of approximately one volume exchange per hour of an internal space. This is one of the most important Energy consuming parts of a building. And since recent buildings tend to become more and more airtight, an autonomous decentralized ventilation system providing fresh air supply is the focus of various researchers working on adaptive building envelopes.

However, the regulation of the above mentioned comfort parameters has been managed in centralized systems over the last decades. Therefore, office buildings have been equipped with huge Heating, Ventilation and Air Conditioning (HVAC) systems consuming significant amount of electrical power in order to ensure static comfort to changing exterior climate conditions. 50% of energy consumption in buildings is caused by HVAC systems which represents one fifth of the total national energy use of European countries. And a massive growth in energy consumption in the EU, is predicted. (Lombarda, L. Ortiz, J. Pout, C. 2008)

But besides energy consumption the demand of additional space in cores, suspended ceilings, basements and rooftops, this conventional building system requires significant space for ducts and machinery within the building volume. Thus, modern building envelopes tend to regulate the four comfort parameters within the façade units by integrating decentralized devices in order to avoid additional space and installation. In the last years, several ready designed 'façade products' have been offered by façade companies integrating energy harvesting components, natural as well as decentralized mechanical ventilation components and sun shading devices within unitized façade systems. The systems Schueco E2, Wicona TEmotion, as well as the mppf developed by the University of Graz, show the state of the art. The main design strategy of the integration of technical devices for internal comfort and energy harvesting into façade products is a modular unitized system. To respond to the dynamic needs of the outside climatic conditions, those façade products address changing weather conditions by regulating façade properties using adaptable devices. Its individual components (modules) are interchangeable and can react differently and specifically to the dynamics of specific contexts.

The diverse requirements on indoor comfort as mentioned above require defined layers within the facade regulating changing external climate conditions. Those layers can interfere as well have synergetic effects with energy harvesting elements integrated in the building envelope. This paper focuses on an exemplary integration of an energy harvesting element using solar thermal components in a fully glazed office façade investigating to what extent active solar façade components can be synergistic to provide visual and thermal user comfort. The façade panel was created as part of the BMU-funded project "Development of solar thermal façade panels with vacuum tubes in office buildings (FKZ 0325956A)". It consists of two connected parts: fully glazed façade panel featuring a triple glazing unit (0,5 W/(m²K) for the unit) of the Wicona Wictec series. A second layer is composed of a layer showing vacuum tubes and a perforated mirror aligned to the sun, which on the one hand effectively draws the radiation onto the absorber layer of the tube, and on the other ensures transparency in the façade. In addition to this selective transparency and the optimized utilization of solar radiation, it provides a sun protection function, which prevents glazed office buildings from overheating.

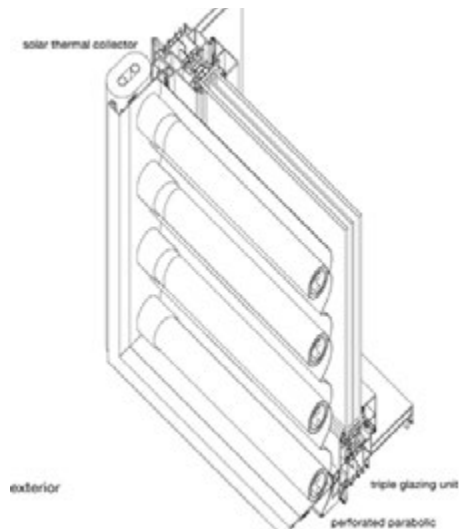

FIG. 1 façade module integrating solar thermal energy harvesting unit.



FIG. 2 photo of the same unit

2 METHODOLOGY

The above mentioned façade unit is tested in regards to its thermal and visual comfort performance. Therefore, interior illumination levels and the potential of the energy harvesting façade as a sun shading device are evaluated in an in situ test cell at the Technical University of Munich. This in situ test cell installed on the roof of the main TU building at a height of about 28 m above ground allows the assessment of the thermal performance of facade elements in one to one scale under natural climate conditions. The cell is south oriented with a 23° rotation towards west. All relevant temperatures as surface temperatures of the adjacent walls ceilings and facades as well as heat fluxes and the weather data are recorded continuously. The cubicle features high insulated exterior walls (U-Value 0,24 W/m²K)



FIG. 3 Test cell and sun path diagram left part fully glazed unit right part semi-transparent collector wall.

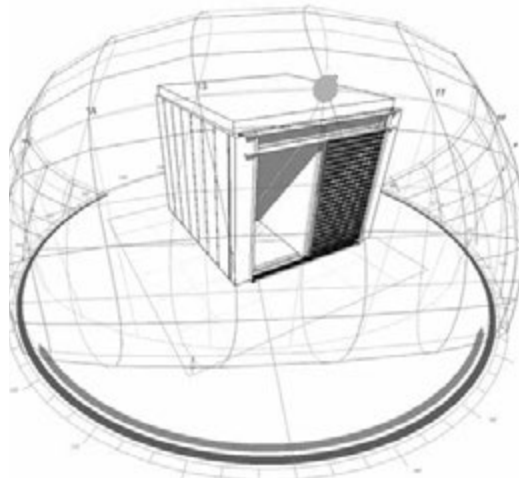

FIG. 4 In situ test unit at the TU München.

The testing series are divided in two series of measurements:

- thermal measurements are set up as comparative measurements to conventional façade systems. They allow architects a concrete and descriptive evaluation that can be compared to a habitual reference. Thus, in addition to an absolute measured value an understanding for non experts can be ensured. The so called “sun shading potential” represents the portion of radiant energy (heat) of a building that can be reduced by an external sun protection.
- measurements in regards to the visual comfort focus on glare, light distribution, external visual reference, Daylight Factor, level of illuminance.

3 THE EXPERIMENT

In order to evaluate the proposed design, a series of measurements aiming on the above mentioned thermal and visual comfort were undertaken. The focuses of the research question are: To what extent can active solar façade components be synergistic to provide visual and thermal user comfort? Can the overlaying functions of a semi transparent façade integrated solar thermal collector serve as a sun shading device and ensure at the same time a sufficient level of daylight besides acting as a energy harvesting exterior envelope?

In a first stage, the test cell was divided in two similar test cells, both of them had opaque high insulated walls (U-Value 0,24 W/m²K). The south facing wall of each test cell was clad with a test subject as shown in fig.3/4.

Between 10.00h and 14.00h, the respective angles of the solar radiation are 10.00h: 57.3 °, 12.00h: 60.5 °, 14.00h: 47.4 °. In the case of a cloudless sky, the temperature in measuring room A (without shading device, without collector field) rose by 7.90K from 24.30 ° C to 32.23 ° C. Compared to this, a temperature increase of 5.2K from 22.80 ° C. to 28.05 ° C. resulted in a temperature rise of 4 hours around the solar level.

From 12.00h the global radiation decreased continuously and reduced to 100 W / m² in a slightly cloudy sky. Nevertheless, the temperature range rose from 14.00h (47,4°) to 16.00h (28,4°) in room A from 32.23 ° C to 38.82 ° C, while the room air in room B of 28,05 ° C to 31.46 ° C by 3.46K. (The values in brackets describe the angle of solar irradiation)

In the following two hours, global radiation fell significantly (to 522 W / m²). Thus, the temperature of the measuring chamber A also fell, since it was at a high temperature level at 38.82 ° C. at 16.00 h. The temperature of the measuring chamber B rose slightly further from 31.46 ° C to 31.54 ° C. This is due to the absorbed heat of the floor, which is now dissipated, since the air temperature was significantly lower than that of the test room A. The temperature difference relative to the volume of the room generated by different solar entries of the south-facing façades reached a maximum of 7.34 K. On a completely cloudless day, the temperature difference could certainly have turned out to be even more pronounced, since very high differences were observed in direct sunlight. The measured difference of 7.34 K at 16.00h between 38.82 ° C in test room A and 31.46 ° C in test room B is considered as a reference point of a sun protection potential against an unshaded façade and is related to the test room, the angle of solar radiation and The climatic conditions of the day.

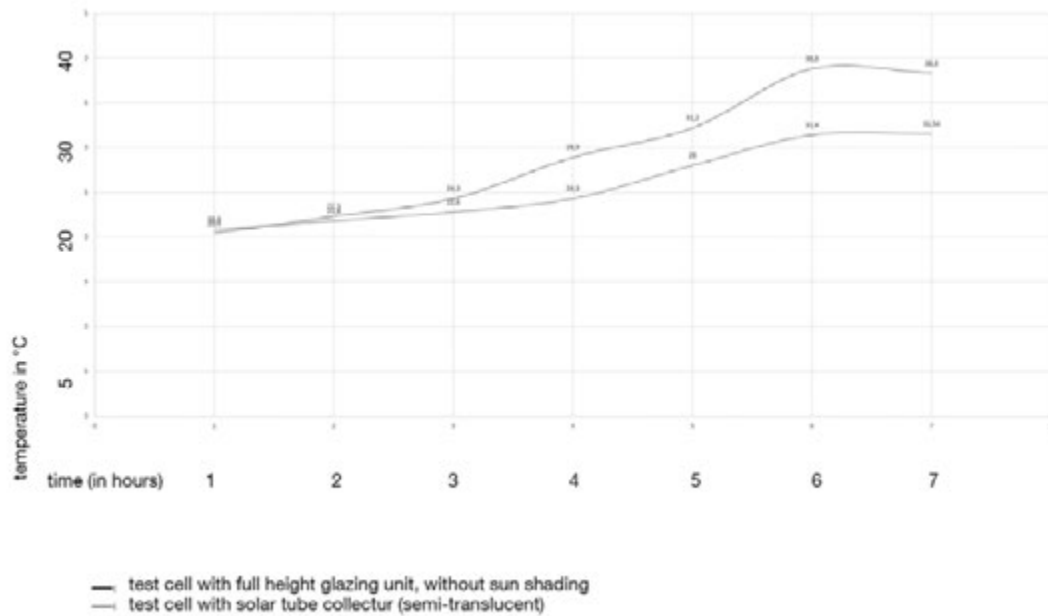

FIG. 5 thermal behavior of two test cells on a summer day. (21.07.2010)

In a second stage, several measurements were undertaken. Therefore, a comparative assessment process had been set up in an in situ test cell unit. The unit was divided in two similar test cells, both of them had opaque high insulated walls. The south facing wall of each test cell was clad with a test subject as shown in fig.3/4. One part was equipped with a functional module integrating solar thermal collector unit, the other part was equipped with a base module without functional module. Both cells were compared in regards to their temperature behavior of the inner space of the test cells at a summer day. The solar radiation would heat up both cells. The unshaded test cell shows a higher temperature level than the test cell which was clad with the semi transparent collector unit. Thus, the test cell showing the lower temperature level was heat up using a heat fan. The supplied electricity to align both temperature levels of both test cells represents the above mentioned "sun shading potential" of the semi transparent solar thermal façade collector. It is depending on the sun angles azimuth and altitude, global and direct radiation, exterior temperature as well as eventual clouds and meteorological interferences in order to be comparable to other in situ measurements. Several series of measurements of the different components were investigated, exemplarily, this paper focuses on the following results.

4 RESULTS

At a summer day (July, 22nd 2010) with high level of radiation, the following sun shading potential was calculated: 638,96 W for the test cell, which represents a relative sun shading potential of 156,03 W/m² (test cycle 2h, sun angles: 41,32°-21,49°, 815 W/m² Global radiation). The second measurements undertaken were in regards to the visual comfort. The façade unit integrating the solar thermal collector unit was evaluated in regards to the following aspects.

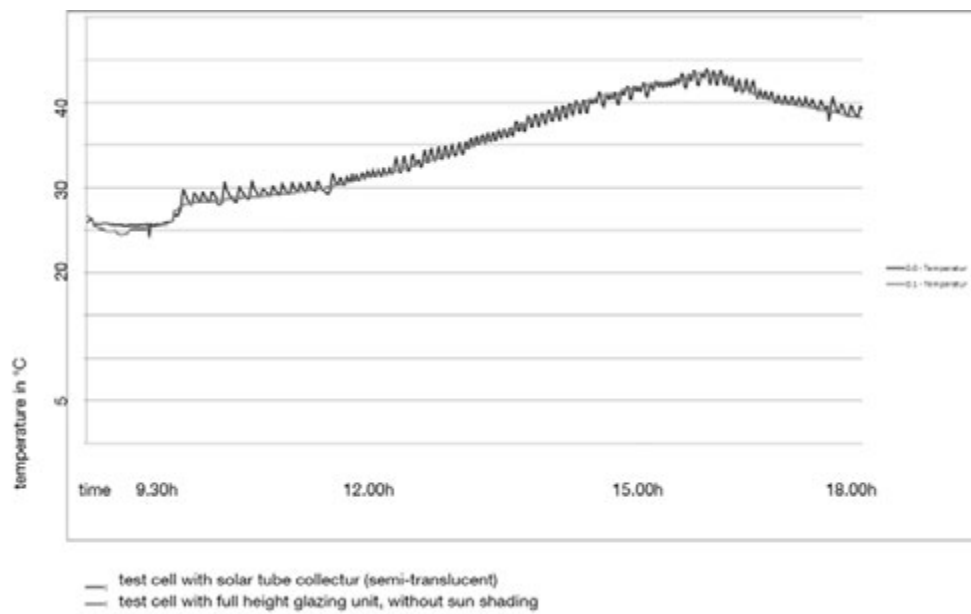

FIG. 6 Temperaturebehaviour of the test cells: Curves of both test units on a summer day. (22.07.2010)



FIG. 7 measurements to the visual comfort: levels of illuminance

The opaque parts of the façade collector create shaded parts in the adjacent internal spaces. Behind the semitransparent solar thermal collector façade module a desk was installed. (fig. 7) On the desktop surface the lighting levels were measured. The investigations of the façade on the interior focused mainly on differences in luminance differences between shaded and non shaded parts of the desktop. The measurements were undertaken on days with high global and direct radiation proportions. On a cloudless day, direct sunlight penetrated directly through the semitransparent collector. The sensors were alternately exposed to direct sun light. Simultaneously other parts of the desktop were shaded by the opaque absorber surfaces of the tubes. The measured intensities of illumination levels showed more than 16,000 lux in the parts receiving direct solar radiation, while at the same time the shaded parts received less than 500 lux.

The solar thermal collector provided partly shadow for the internal spaces behind. However, the opaque parts of the absorbers alter with transparent parts, which creates differences in levels of luminance, which causes glare to human eyes. In the direct field of view a ratio of 5,543 : 1 was measured, due to a pattern that occurred on a working desk surface by the differences between shaded and non shaded parts behind the semi transparent wall. For the extended field of view, a ratio of 11,666 : 1 was measured due to an extraction of light/radiation from the solar tubes which were exposed to direct sun light. According to DIN, a the ratio of levels of luminance which lead to glare, must not exceed 3:1 for the direct field of view and 10:1 for the extended field of view. For the same façade module (Semi transparent façade unit integrating a solar thermal collectors) a daylight factor of 1,25 had been measured.)

5 CONCLUSION

Especially in situations with lower sun angles, in the morning and the evening hours during the summer months, significant amount of solar gains were measured. In these cases, the increase of temperature behind the facade collector is very high. The static sun protection effect is evaluated with an Fc value of 0.45 on the basis of the measurements. This means that an additional sun protection is necessary.

The investigations on visual comfort show the complexity of the dialectic between energy production and the daylight properties of a façade: the energy-winning elements impair the transparency and thus the continuation of the light supply into the interior. Moreover, the energy harvesting façade components and can not adapt to the changing external daylight intensities. The measured lighting levels above 16,000 lux require additional glare protection.

References

- ASHRAE Standard (1981) Thermal comfort conditions for human occupancy. Atlanta: American Society of Heating Refrigerating and Air Conditioning Engineers.
- Beranek L. Balanced (1989) Noise-Criterion (NCB) curves. Journal of the Acoustical Society of America.
- Borisuit, A. Scartezzini, J.L. Thanachareonkit A. (2010) Visual discomfort and glare rating assessment of integrated daylighting and electric lighting systems using HDR imaging techniques Archit Sci Rev, 53
- ISO Standard 7730 (1983). Moderate thermal environments. International Organization for Standardisation.
- Construction Perspectives and Oxford Economics (2011): Global Construction 2020, London
- Cremers, J. (2015) Atlas Gebäudeöffnungen, München, Detail.
- Coulouris, G., Dollimore, J., Kindberg, T. (2005): Distributed systems: concepts and design. Harlow: Addison-Wesley
- Day, J.K. Gunderson, D.E. (2015) Understanding high performance buildings: The link between occupant knowledge of passive design systems, corresponding behaviors, occupant comfort and environmental satisfaction
- Pfafferott, J., & Kalz, D. (2007) Zielwerte für primaereenergetisch optimierte Buerogebaeude im EnOB-Forschungsbereich »Energieoptimierter Neubau« (EnBau). Bine Informationsdienst Themeninfo I/2007. p. 5
- Pérez-Lombarda, L. Ortiz, J. Pout, C. (2008) A review on buildings energy consumption information, Energy and Buildings
- Pérez-Lombard, L. Adnot, J. Ortiz, J.A. Rivière, P. (2004) HVAC systems energy comparisons for an office building Proceedings of the Climamed, Lisbon

Multi-active façade for Swedish multi-family homes renovation: Evaluating the potentials of passive design measures*

Susanne Gosztonyi^{1/2}, Magdalena Stefanowicz¹, Ricardo Bernardo¹, Åke Blomsterberg¹

¹ Energy and Building Design, Architecture and Built Environment, LTH, Lund University

² Façade Research Group, Design of Construction, Architectural Engineering and Technology, TU Delft, Julianalaan 134, 2628 Delft, The Netherlands, e-mail: Contact: s.gosztonyi@tudelft.nl, susanne.gosztonyi@bionicfacades.net

Abstract

In order to meet the Swedish energy efficiency objectives for the built environment until 2050, a particular building stock has to be addressed: the houses of the Million Homes Programme, an ambitious housing programme of the 1960s and 70s that resulted in a large number of standardized multi-family houses all over Sweden. These are in need of upgrading the energy and comfort quality to current standards, which provides an excellent opportunity to investigate the potentials of 'prefabricated multi-active' façades for refurbishments on large scale. While 'prefabrication' is linked to cost-effectiveness and high replicability, 'multi-active' addresses the potential of embedded active and passive measures for improved energy efficiency and energy regulation out of the façade. Integrated building services technologies, solar technologies or moveable components, such as shading systems, are considered active measures. Passive measures include physical and constructive measures, such as e.g. thermal insulation or selective coatings of glazing's, and provide a "passive" energy flow control to improve the thermal quality of the building envelope. Many of these strategies are well-known, traditional solutions. Although they do not provide an energy-generating or -supplying function, they dynamically interact with environmental changes; preheating of supply air through the air cavity of a façade construction or adaptive thermal buffer zones are just few of many examples. The question is how traditional passive strategies can be used to contribute most effectively to the demanded energy efficiency. The paper presents first results from an assessment dealing with this question: Two traditional 'passive' façade strategies, a curtain wall system and closed balconies, have been analysed in regards to their impact on energy balance and their thermal behaviour in a defined renovation scenario. The assessment aims to support the development of a multi-active facade concept suitable for large-scale refurbishments of the multi-family houses in Sweden, which is part of the initial phase in the pre-study "Multi-active façade". The pre-study considers architectural, technological and constructive aspects, energy performance and indoor comfort optimization, but also economic feasibility and constraints to get replicable on large scale. So-called added values that concern the upgrade to modern living standards and expectations by inhabitants and the market value of the building are also touched. The paper discusses, based on a technology screening to identify suitable key measures, the energy saving potential and impact on thermal indoor comfort of two passive renovation strategies for facades.

Keywords

multifunctional façade, multi-active façade, energy renovation, multi-family buildings, passive measures, Sweden

* Full paper published in JFDE / Journal of Façade Design and Engineering, Volume 5, Number 1, 2017.

DOI 10.7480/jfde.2017.1.1425

Light-transmitting energy-harvesting systems – Review of selected case-studies

Marcin Brzezicki¹

¹ Faculty of Architecture, Wrocław University of Technology, Prusa 53/55, Wrocław, marcin.brzezicki@pwr.edu.pl

Abstract

Energy-harvesting systems installed on facades are becoming more and more common. Technologies at different stages of development are currently used. Apparent energy-harvesting devices (e.g. older-generation freestanding solar collectors or solar panels) are gradually being replaced by technologies that integrate those systems with the building's envelope through miniaturization, lamination and surface mounting (e.g. integrated PV). At present, the integration of energy-harvesting elements with the building shell involves the use of elements such as opaque façade cladding but also, most recently, the development of virtually "invisible" light-transmitting and transparent systems. This paper presents case studies of both systems and takes into consideration their influence on façade appearance. The influence of energy-harvesting system on the architectural form could also be regarded as the opportunity to increase social awareness of the need to reduce fossil fuel consumption and turn to alternative sources of energy.

Keywords

PV, BIPV, energy-harvesting, transparency

1 INTRODUCTION

The introduction of energy-harvesting systems affected both the architectural form and its perception. Apparent energy-harvesting devices elements (e.g. older-generation freestanding solar collectors, classic PV cells, collector tubes) have influenced architecture to an extent that many architects consider unacceptable. The growing disapproval of clients combined with pressure from architects led to the formation of an important technological and formal trend toward system integration (integration seen as a strive for visual resemblance or at least the lack of visual oddity). Their efforts resulted in the integration of energy-harvesting systems with the building's envelope through the application of miniaturization, lamination and surface mounting (e.g. Building Integrated Photovoltaics – BIPV). Most of the recently developed light-transmitting systems offer the benefits of energy-harvesting while reducing their negative influence on the architectural form. With the introduction of transparent systems, energy-harvesting might go almost unnoticed. This is still not true for the current state-of-the-art technology but the development of the most advanced system, can be followed by analyzing the case-studies presented below which illustrate both the recent trends and the practical applications of certain technologies.

2 TYPOLOGY

Just like windows, energy-harvesting systems benefit from the Sun. As a result, a peculiar competition in the access to daylight is created. On a classic window façade the energy-harvesting system typically replaced or covered the non-visual parts of the façade (usually the cladding), without interrupting the penetration of daylight. In the case of contemporary fully-glazed facades this is considered problematic as classic energy-harvesting systems (e.g. PV and tube collectors) are opaque. Their elements block the light, obstruct the view and – with a few exceptions – are generally considered a disturbance of the architectural form. The ideal solution would be to combine an unobstructed view with maximum energy efficiency. Recent studies show that this could be achieved by developing light-transmitting systems in which only a portion of energy is transmitted while the remaining part is harvested in the form of heat or electrical energy. Depending on the technology, today's light transmitting systems include:

- binary systems – when only a portion of light transmission is blocked by opaque energy-harvesting elements that are randomly or evenly scattered on the pane's surface. The term binary is used because the opaque portion has a transmittance of 0%, whereas the light-transmitting part has a transparency of a glass pane (presumably greater than 0%) and the change in the system's optical parameters is immediate. As a result a binary interruption is created where the system affects the interior or the façade of a building by casting shadows that correspond to the arrangement of opaque energy-harvesting elements,
- homogenous systems – when a bona-fide transparent system is used causing a homogenous decrease in light intensity – homogenous interruption occurs. Light intensity is homogeneously weakened across the whole surface of the pane/system element (e.g. in light-transmitting PV cells).

3 METHODOLOGY

The appraisal of the architectural/esthetic value of a building is based on observation and the viewer's impression rather than on measurement. Field observation is an essential component of the proposed scientific method and plays an important role in collecting data and formulating insights. The presented brief review is based on in-situ research and case studies – photographic documentation of existing buildings and available prototypes. The field study was recorded with digital photography. The selection of case study buildings was preceded by an analysis of written resources, available databases (PV Database) and architecture criticism relating to the specific use of energy-harvesting systems (Parida et al, 2014). All selected case-studies meet the following five formal criteria for proper energy-harvesting systems integration formulated by Henk Kaan and Tjerk Reijenga (Kaan and Reijenga, 2004, p. 398):

- Natural integration of the system,
- System is architecturally pleasing, within the context of the building,
- Good composition of colors and materials,
- The dimensions of the system should match the dimensions of the building,
- The system matches the context of the building.

Furthermore, the selected case studies are assessed and classified based on Reijenga classification (Kaan & Reijenga, 2011), according to which energy-harvesting system are analyzed from the architectural/formal perspective.

4 OPAQUE SYSTEMS (NON LIGHT-TRANSMITTING)

Opaque systems are characterized by light absorption of 100%, which – in architectural terms – means that the system functions as a shading element and blocks the view completely. This is the main reason why solar collectors and PV polycrystalline and monocrystalline cells are usually integrated into opaque cladding elements: spandrels, pillars, non-visual sections of the façade, roof tiles. Some manufacturers of PV systems specialize in custom-made cladding systems tailored to the cladding of a particular building, such as the GVZ-Halle L in Ingolstadt (Case-study no 1 – see Fig. 1A), so that the system remains almost unnoticeable and is very well integrated with the building. A good example is the building of the Brussels Environment Company (Case-study no 2 – see Fig. 1B).

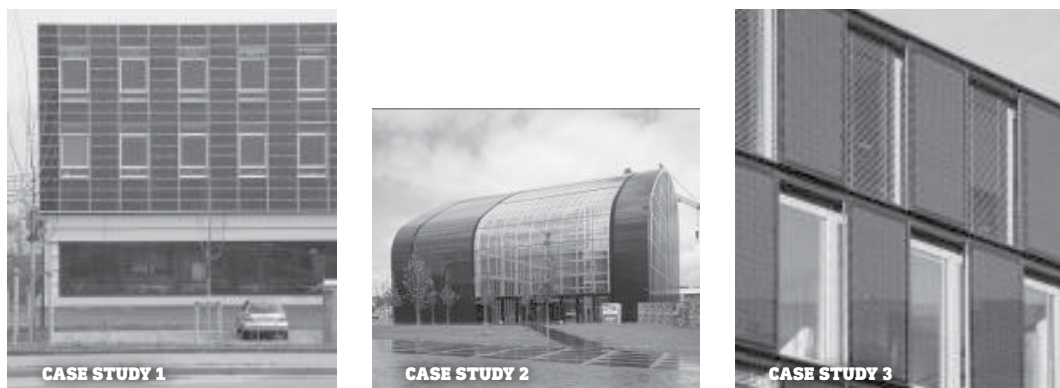

FIG. 1 Different levels of PV integration with the building's shell: From left to right: A. GVZ-Halle L (arch. pbb Firmengruppe, 2003). B. Brussels Environment Company (arch. architectenbureau cepezed, 2014). C. Bonneshof Office Center in Düsseldorf (arch. RKW, 2014). Photographs by the author.

Since the transmission of light is completely blocked, mono- and polycrystalline cells produce the optical phenomenon of iridescence when reflecting light. This phenomenon results from the structure of the silicon crystals and the very thin layers of coatings that are deposited in the manufacturing process. Iridescence is highly angle-dependent and thus its influence is conditioned by both: the observer and the position of the light source. In terms of architectural form, iridescence could be considered both an advantage and disadvantage, especially since some architects consider PV cells gaudy and flashy (even if there are few colors of PV cells available that could match the building's color). This feature is absent in the most recent buildings, such as the Bonnehof Office Center in Düsseldorf with the PV system developed by the Schueco company (Fassade mit Mehrwert, 2014). The black-colored PV elements are very well integrated into the façade and represent very high formal quality. The energy-harvesting and standard cladding elements are almost indistinguishable when viewed at a certain distance and the difference can be captured only by a telephoto lens (Case-study no 3 – see Fig. 1C).

5 LIGHT-TRANSMITTING SYSTEMS

The recently developed light-transmitting systems and their prototypes provide the next level of energy-harvesting integration and are an answer to the need of less visible and less formally prominent elements. The attempts to eliminate the negative influence of such systems on the architectural form are rooted in well-established architectural theories of transparency, honesty and openness and their influence on the building form.

5.1 BINARY SYSTEMS

Binary systems are composed of light-transmitting regions and adjacent opaque energy-harvesting elements, all of which are in one plane. The binary system is created by a scattered arrangement of individual energy-harvesting elements on the pane and its transmissive properties depend on their exact location and size. The elements (such as PC cells, solar tubes) can be positioned in different patterns and densities. The light-transmittance of the system is referred to as the ratio of the area that is clear to the area that is obstructed.

When a binary system is applied to the visual section of the façade results the view becomes obstructed. This problem can be solved through an irregular positioning of individual energy-harvesting elements, which are grouped above or under the "window" so as not to obstruct the view. Examples of such arrangements can be observed in the Solarthermie in the Fassade façade prototype (see Case-study no 4 – Fig. 2A), or in the completed Lyon housing Hikari building (see Case-study no 5 – Fig. 2B). The density (position and size) of the energy-harvesting elements regulates the passage of daylight through the façade and might be also used for shading "in order to avoid overheating in summer" (Reijenga, 2003, p. 1009).

The densities depend on the size and shape of PV cells and on the distances between them. As shown in the case-studies below (Case-study no 6 – Fig. 3A and case-study no 7 – Fig. 3B) not only different patterns and angles are possible, but also different decorative shapes can be created, e.g. maple leaves.



FIG. 2 The positioning of opaque energy-harvesting elements is usually designed not to obstruct the view: From left to right: A. Façade prototype: "Solarthermie in the Fassade". The Institute for Building Construction and Design III (2008, exhibited at Glasstec 2008). B. Lyon housing Hikari (arch. Kengo Kuma, 2015). Photographs by the author.

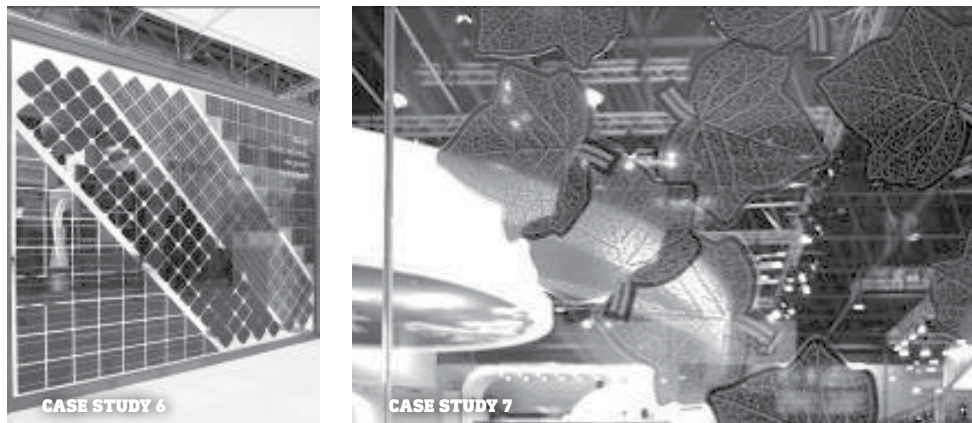

FIG. 3 Different types of binary systems. From left to right: A. Collage of mono- and polycrystalline cells, Ertex Solar GMBH (2008, exhibited at Glasstec 2008). B. Semi-transparent leaf-shaped organic PV cells by Belectric OPV GMBH. (2008, exhibited at Glasstec 2012) Photographs by the author.

The transmissive properties of the binary system depend on the properties of the transparent system base. PV cells are usually laminated between two panes of transparent glass and therefore the choice of the glazing layers determines the visual performance of the system. Because glass is a very smooth material, one must not forget that a glazed panel viewed at an angle greater than 45 deg. produces distinct reflections which gradually become more evident than the transmitted image. This also applies to homogenous systems that use uncoated glass (see Chapter 5.2). Another consequence of using the binary system is an uneven shadow that is cast by energy-harvesting elements depending on their arrangement between the glass panes. The benefit of installing a binary system on a surface is that transparent panes are better recognized by human cognitive systems. Individual PV cells function as markings on the glass. An additional key factor that influences the appearance is the size of opaque elements. A technology is currently available that splits and decreases opaque PV cells. A binary system of evenly scattered miniature opaque PV cells on a glass pane can be perceived as homogenous. This is due to the spatial acuity of the human eye ("limited resolution") which makes the micro-scale patterns appear as if they homogeneously decreased the transparency.

5.2 HOMOGENOUS (TRANSPARENT) SYSTEMS

In terms of optical properties a homogenous system partially absorbs and partially transmits light – it is transparent. Because heat-collecting systems whose absorbers are mainly a compound made of metal) and classic mono- or polycrystalline technologies are opaque, the design of homogeneously transparent systems is usually based on photovoltaic principles in combination with recently developed coating technologies.

Transparent energy-harvesting systems are paradoxical in that light is supposed to be transformed into electrical or heat energy, rather than transmitted. The designers of transparent energy-harvesting systems eliminate this ambiguity by using different modes of operation. Despite this, the performance of prototype transparent systems is lower, ranging from 2% to 4% in comparison with opaque systems, which achieve up to 18,2% of efficiency (e.g. Polysolar's PS-MC-SE Series panels). Transparent layers used in homogenous systems require higher manufacturing standards, advanced technologies of coating deposition, dye screen print, organic compounds (e.g. polyphenylene vinylene) or thin film (see Case study no 8 – Fig. 4A and case-study no 9 – Fig. 4B).

Many technologies of transparent PV cell production are currently available. Some products are marketed as "photovoltaic transparent glass" despite the fact that their transparency values range only from 10% to 30%. Onyx uses a-SI and CIS/CIGS to achieve this level of transparency. Polysolar offers new Cadmium Telluride based PS-CT panels with transparency reaching 50% (Polysolar, 2015). Colorless panels are rare on the market, the usual tint being brownish. Polysolar manufactures a-SI based panels with a distinguishable amber tint. The new Swiss-Tech Convention Center in Lausanne in Switzerland (arch. Richter Dahl Rocha & Associés, 2014) features an electricity-producing glass façade made of dye-sensitized solar cells. "Apart from being translucent, the angle of incidence of light makes no difference to the cells, which can be vertically deployed without any loss in performance. In addition to generating electricity from renewable sources, they protect the building from direct sunlight and thus reduce the necessity for using cooling energy." (Richter Dahl Rocha..., 2014) The formal result is more than pleasing as transparent PV cells are adjacent to each other to resemble "stained glass" thus producing an interesting visual effect of backlighting as well as casting colorful shadows on the building floor (Case-study no 10 – see Fig. 5A.)

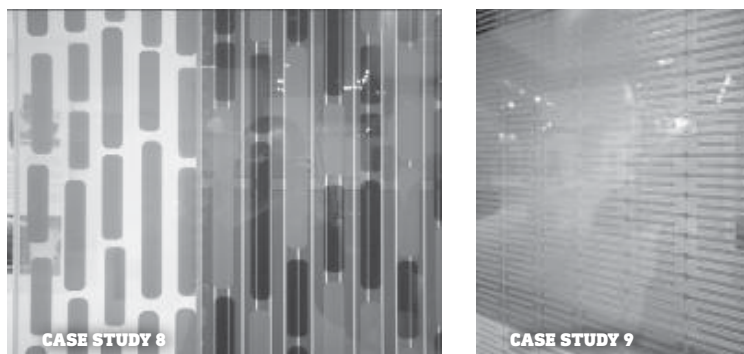

FIG. 4 Homogenous systems PV cells: From left to right: A. Transparent organic PV glass element by Bischoff Glass AG and Konarka Technologies GMBH (exhibited at Glasstec 2012), B. Dye solar cell module by Fraunhofer Institute für Solare Energiesysteme (exhibited at Glasstec 2012). Photographs by the author.

Almost completely transparent PV cells (55÷70% of transparency) can be manufactured by means of two technologies, which are currently in the prototype stage and which employ spectrally-selective filters and layers. The first one develops a PV cell that transmits the visible spectrum, while ultraviolet and infrared waves are used to generate electricity. The result is outstanding as the PV cell looks virtually like a clear pane of glass. Two similar technologies were developed: (i) a technology based on “small-molecule compounds” at MIT in 2011 (Lunt, Bulovic, 2011), and (ii) an analogous polymer solar cell with almost 4% of power conversion at UCLA in 2013 (Lunt, 2012).

The second technology is based on luminescent powders and luminophores incorporated into an optical epoxy layer which can be induced to re-emit a certain percentage of the absorbed photons. Those re-emitted UV and IR photons travel inside the pane of glass utilizing the fiber optic phenomenon of multiplied reflections (Case-study no 11 – see schematic diagram Fig. 5B). This portion of photons is used to generate electricity in the PV cells that are mounted along the edges of the glass pane. This area is relatively small but with the application of special heat-mirrored coatings the fiber optics phenomenon can be reinforced, and – as the efficiency of PV cells increases– they can generate satisfactory gains. Recent research has produced the “remarkable result of routing in excess of 20% of the total radiation energy reflected off its back coating towards the PV modules”, which resulted in PV efficiency of 3,8% (Alghamedi et al, 2014) with transparency reaching 55%.

Very innovative transparent energy-harvesting systems were developed as prototypes at IBA Hamburg in 2013 in the BIQ housing building (called also Algae House). The system features a thin glazed tank called “bioreactor” which creates a bio-habitat for algae (Case-stud no. 12, see Fig. 6A and B). “They enable the house to supply its own energy. The only thing that the algae have to do is simply to grow. They are continuously supplied with liquid nutrients and carbon dioxide via a separate water circuit running through the façade. With the aid of sunlight, the algae can photosynthesize and grow.” (BiQ, 2013)

What is even more important in the context of this paper is that bioreactors “can also control light and provide shade” (BiQ, 2013) as the greenish tint of the water inside the tank changes according to the phase of the algae’s grow. From the architectural perspective the unique feature of the bioreactor façade is its variability as the bubbles circulating in the tank constantly change the façade’s optical properties.

The mentioned case-studies are listed in the following table below and classified according to the Reijenga Classification system: “1 – applied invisibly; 2 – added to the design; 3 - adding to the architectural image; 4 – determining architectural image, 5 – leading to new architectural concepts” (Kaan, Reijenga, 2011). See Tab. 1.

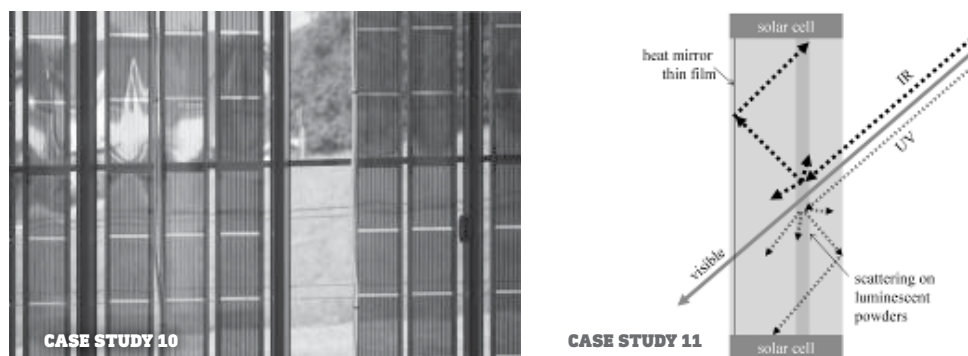

FIG. 5 A. Swiss-Tech Convention Center in Lausanne (arch. Richter Dahl Rocha & Associés, 2014) – the use of dye-sensitized solar cells. B. The operating principle of a transparent cell with the use of a luminescent scattering layer and luminophores (based on Alghamedi et al, 2014). Photographs by the author.

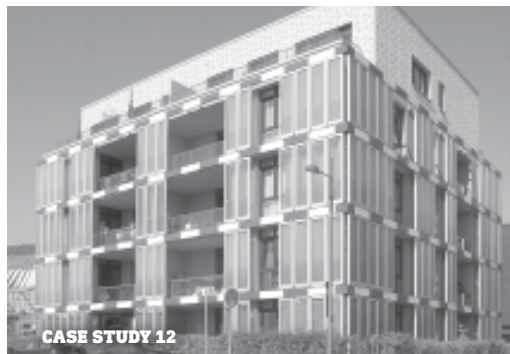

FIG. 6 BIQ housing building, IBA Hamburg (arch. Splitterwerk, 2013), B the detail of the system in operation. Photographs by author.

NO.	NAME:	ARCHITECT/DESIGNER/INVENTOR:	YEAR:	REIJENGA CLASSIFICATION
1	GVZ-Halle L	pbb Firmengrup	2003	2
2	Brussels Environment Company	architectenbureau cepezed	2014	1
3	Bonneshof Office Center	RKW	2014	1
4	Solarthermie in the Fassade	Institute for Building Construction and Design III, Stuttgart	2008	3
5	Lyon housing Hikari	Kengo Kuma	2015	4
6	Collage of mono- and polycrystalline cells	Ertex Solar GMBH	2008	3
7	Semi-transparent leaf-shaped organic PV cells	Belectric OPV GMBH	2008	4
8	Transparent organic PV glass element	Bischoff Glass AG and Konarka Technologies GMBH	2012	2
9	Dye solar cell module	Fraunhofer Institute fur Solare Energiesysteme	2012	2
10	Swiss-Tech Convention Center in Lausanne	Richter Dahl Rocha & Associés	2014	4
11	Luminescent scattering layer	Alghamedi et al	2014	1
12	BIQ housing building, IBA Hamburg	Splitterwerk	2013	5

TABLE 1 Reijenga Classification of the case-studies and prototypes featured in the paper

6 CONCLUSIONS

The presented brief case-study shows a rapid development of opaque systems whose PV/collector elements are frequently being integrated into the building cladding. The most recent systems that have been integrated with the building's cladding are almost unnoticeable for the viewer. What takes integration of energy-harvesting technology one step further are light-transmitting systems. Binary systems provide both the unobstructed view and the possibility to harvest energy, while being relatively neutral for the architectural form. If skillfully applied, they might even create positive esthetical impressions e.g. by causing individual energy-harvesting elements to be perceived as patterns or decoration. Homogenous systems still can not be compared to a pane of clear building glass but with transparency reaching levels of 55-70% they are a good alternative to opaque or light-transmitting binary PV cells. This also lowers their impact on the architectural form, as they partially transmit light. In some cases light-transmitting binary technologies might be regarded as beneficial for the building's overall energy balance due to their shading properties.

The light-transmitting properties of energy-harvesting systems also influence the reflective properties of the material. The older-generation opaque mono- and poly-crystalline systems are easily recognizable because of the characteristic iridescence of the reflected light, whereas recent technologies, as stated above, remain almost indistinguishable from the cladding. Homogenous systems, being mainly glass-based, have similar properties to panes of glass and their transparency also depends on the viewing angle. Compared to standard building glass the decreased passage of light might strengthen the reflections that are visible on the pane.

Since energy-harvesting systems are desirable from the energy saving perspective (in some cases they are also required by law) they might also serve as the basis for further study of contemporary architectural forms, and for the formulation of perspectives for future applications. The installation of energy-harvesting systems could also be regarded as an opportunity to increase public awareness of the need to reduce fossil fuel consumption and to turn to alternative sources of energy.

Acknowledgements

This paper was funded by the Polish National Science Centre grant entitled: "New trends in architecture of transparent facades – formal experiments, technological innovations ", ref. no. 2014/15/B/ST8/00191.

References

- PV Database, Urban-Scale Photovoltaic Systems (2008) For more information see: <http://www.pvdatabase.org/projects.php>
- Parida, B., Iniyar, S., Goic R. (2010) A review of solar photovoltaic technologies, *Renewable and Sustainable Energy Reviews*, Vol 15, 3, 2011, pp. 1625-1636.
- Kaan, H., Reijenga, T. (2004) Photovoltaics in an Architectural Context, *Progress In Photovoltaics: Research and Applications*, 12, pp. 395-408
- Fassade mit Mehrwert (2014) *db deutsche bauzeitung*, 11, For more information see: <http://www.db-bauzeitung.de/db-empfehlprodukte/fassade-mit-mehrwert/>
- Reijenga, T. (2003) PV in Architecture, *Handbook of Photovoltaic Science and Engineering*. Ed by A. Luque and S. Hegedus, pp. 1005-1042.
- Polysolar (2015) Thin-film Photovoltaic Glazing for BIPV solutions, For more information see: <http://www.polysolar.co.uk/Technology/thin-film>
- Richter Dahl Rocha Develops Innovative Façade for SwissTech Convention Center (2014) For more information see: <http://www.archdaily.com/491135/richter-dahl-rocha-develop-innovative-facade-for-swisstech-convention-center>
- Lunt, R. R.; Bulovic, V. (2011) Transparent, near-infrared organic photovoltaic solar cells for window and energy-scavenging applications. *Applied Physics Letters*. 98 (11).
- Lunt, R. R. (2012) Theoretical limits for visibly transparent photovoltaics. *Applied Physics Letters*. 101 (4).
- Alghamedi, R, Vasiliev, M., Nur-E-Alam, M., Alameh, K. (2014) Spectrally-selective all-inorganic scattering luminophores for solar energy-harvesting clear glass windows, *Scientific Reports* 4, Article number: 6632 (2014), For more information see: <http://www.nature.com/articles/srep06632>
- BIQ (2013) For more information see: <http://www.iba-hamburg.de/en/themes-projects/the-building-exhibition-within-the-building-exhibition/smart-material-houses/biq/projekt/biq.html>
- Kaan, H., Reijenga, T. (2011) PV in Architecture, in *Handbook of Photovoltaic Science and Engineering*, (eds A. Luque and S. Hegedus), John Wiley & Sons Ltd, Chichester.

Silicones enabling crystal clear connections

Valérie Hayez¹, Dominique Culot², Markus Plettau³

1 Dow Corning Europe S.A., Parc Industriel Zone C, B-7180 Seneffe, Belgium, +32 64 888 263, valerie.hayez@dowcorning.com

2 Dow Corning Europe S.A., Parc Industriel Zone C, B-7180 Seneffe, Belgium, +32 64 888 444, d.culot@dowcorning.com

3 Dow Corning GmbH, Rheingaustrasse 34, D-65201 Wiesbaden, Germany, 49 611 237 498, markus.plettau@dowcorning.com

Abstract

A façade is quite literally, the face of a building, the signature of its owner or the architect, with much consideration dedicated to its conception. Major advances in glazing and façade technology over the past 30 years have enabled fully glazed sustainable designs providing the demanded aesthetic, whilst respecting occupant benefits such as natural daylight and integration of energy efficiency systems. This explains the significant and growing interest for increased glass in facades in commercial buildings. The use of bulky frames limiting the transparency of a façade can be minimized through point fixation or structural glazed fixation systems. Yet even these have their limitations since the adhesive being used are not necessarily both transparent and durable. This paper discusses the design possibilities offered by established silicone technologies as well as a new generation of optically clear structural silicones, as a film or a hot-melt.

Already well-established for façade exteriors, a high strength and optically clear elastic silicone film adhesive is designed for point structural bonding of glass in a variety of shapes. A similar high strength clear film laminate for interior is also available for point and area lamination connecting glass to glass. Its durability, high strength and elastic properties provide significant advantages, targeting applications like structural bonding of glass stair cases, glass beams and other interior decorative glass connections. A very recent breakthrough technology is an optically clear hot-melt silicone for linear structural bonding and sealing which can be done on site. Application examples are: total vision glass sealing, structural glazing, glass bonding of closed cavity facades, shadow boxes, partition walls and even for specific insulating glazing designs this new technology has generated interest. Strength and durability combined with its unique aesthetics and transparency open up a new dimension in architectural design freedom.

Keywords

optically clear silicone, transparent design, high strength, silicone film, point fixation, linear bonding

1 INTRODUCTION

Structural Glazing is a well-known technology enabling glazed façades for over 40-years. Structural glazing has been used to enable architectural design through the reduction – and in some instance the elimination - of exposed metal, by reducing sightlines and smoothing the surface texture and tautness of the exterior glass façade. In response to the continued architectural quest to maximize facade transparency and break the visual barrier between the interior and exterior environments, optically clear silicone bonding technologies enhance and enable the aesthetics of a façade.

Already well-established for façade exteriors, the clear silicone film (transparent structural silicone adhesive or TSSA) provides higher permanent design strength when compared to conventional structural glazing silicones. It is designed for point structural bonding of glass in a variety of shapes (round, rectangular, triangular, etc). Similarly, a clear film for interiors (transparent structural silicone laminate or TSSL) is also available for point and small area lamination. Its durability, high strength and elastic properties show significant advantages, especially in interior applications like structural bonding of stair cases, glass beams or other interior decorative glass connections.

The latest developed clear technology is an optically clear silicone for structural glazing of glass facades, weather sealing and other glass bonding applications, where clear aesthetics is required. Examples are: glass bonding in closed cavity façade designs with invisibly fixed exterior glass, total vision glass, weather sealing, partition walls, etc. This technology maximizes transparency and opens up a new dimension in architectural design freedom.

A review of the technical attributes and applications of these different clear silicones will highlight how they can be utilized to enable the architectural quest for filigree facade structures with high degrees of transparency.

2 TRANSPARENT STRUCTURAL SILICONE FILM ADHESIVE AND LAMINATE

2.1 PERFORMANCE

Transparent Structural Silicone Adhesive (TSSA) is an optically clear and high strength structural silicone adhesive film designed to be applied between glass and metal supporting components at 1mm thickness to provide flush and smooth options in comparison to those strategies that require drilling and mechanical fastening of glass. By eliminating the traditional need to drill through the glass for placement of retaining bolts and the use of gaskets to retain air tightness at the point of fixation, it ensures superior durability and longevity, as the gas-filled insulating glass cavity remains untouched. Therefore, it contributes to a more thermally sustainable insulation of the façade. Physical properties of this material and engineering applications have been established and published (Sitte, 2011). Based upon extensive testing of durability according to ETAG002 requirements (EOTA 2005), TSSA is approved for exterior glass façade applications with dynamic design stress of 1.3 MPa and static design stress of 0.6 MPa (IFT, 2011). These design values are about 50 times higher than those allowed for conventional structural silicone sealants (Dow Corning, 2016). The higher engineering Young's modulus of 9.3 MPa along with its 1 mm thickness limit the need for compensation of thermally induced movements (Santarsiero, 2016). The silicone film adhesive is supplied in sheets or in a pre-cut shape ready to use on the point fixation system.

Transparent Structural Silicone Laminate (TSSL) is specifically validated for interior applications only. The TSSL shows strong advantages in strength and flexibility which allow accommodating much more movements and vibrations occurring on glass stairs and railing glass beams for instance. The TSSL is supplied on a roll only. The dynamic design stress is 1 MPa and the static design stress is 0.6 MPa (IFT, 2011).

2.2 EXAMPLES OF APPLICATIONS

The single glazed facade of the new office building of Press Glass in Croatia was secured using SADEV architectural glass components for the point-fixing (Sadev, 2016). Over 2000 points were bonded by Press Glass to the tempered or laminated glass panes also manufactured in their factories, with TSSA film, as an alternative to using the traditional method of drilling into the glass for insertion of bolt fixings. A sleek aesthetic and improved transparency is obtained as the glass panes are not breached, thus retaining the integrity of the glass. It also allowed the glass thickness to be reduced from 25.4 mm to 17.52 mm permitting the weight and cost of the glass to be reduced. TSSA was also used for bonding the point-fixing bolts on the glass balustrades (Figure 1). The use of TSSL in a glazed staircase is illustrated in Figure 2. A stainless steel L profile has been laminated to the glass stair stringer using TSSL clear thin high strength silicone film. The assembly of the glass stair to the glass stringer on site was done with a conventional, manually applied black silicone. This can be now replaced by a clear structural bonding (see paragraph 3).



FIG. 1 Left: Example of TSSA application (PressGlass office, Croatia). Right: detail showing the optical clarity of the silicone film



FIG. 2 Example of Interior glass-metal bonding using TSSL (picture from Glas Trösch: Swisstep Bond)

3 TRANSPARENT STRUCTURAL SILICONE SEALANT

For more than 15 years, development of an optically clear hot-melt silicone adhesive has evolved and yielded different generations of the adhesives to be commercialized, each targeting various applications within the residential fenestration and light commercial sectors (e.g. bonding of windows and doors). The primary advantage of this technology is provided by the high initial tack (also known as green strength) enabling quicker movement of the bonded units resulting in increased productivity – in comparison with other technology platforms used in this market sector (Hautekeer, 2005).

The earlier generations of generic hot-melt technology are typically limited in creep resistance, making them unsuitable for structural glazing applications. Recent developments address the creep observed in the incumbent technology and give rise to a broader, and more stable, strength application.

3.1 PERFORMANCE

3.1.1 Optical clarity

In order to quantify the clarity of the sealant, the transparency (ASTM, 2013) (ISO, 2001) was measured after 4 weeks of cure (fresh) and no ageing using a spectrometer (Figure 3). The measured sample is build up with 2 mm sealant sandwiched between two glass plates of each 4 mm thickness. No distortion nor color change is observed between the glass and silicone. This measurement was repeated after ageing of the sample at different conditions. No significant difference was recorded after exposure to dry heat (1000 hours at 100 °C), high temperature and humidity (85 °C and 85 % RH) or thermal shock testing (exposure for 30 min at -40 °C or +125 °C with 10 sec switching time between temperatures). Between 450 and 800 nm, differences of 2-7 % were observed. No yellowing was observed after 10000 hours exposure to UVA-340 lamp as illustrated in the figure 4 (ASTM, 2012).

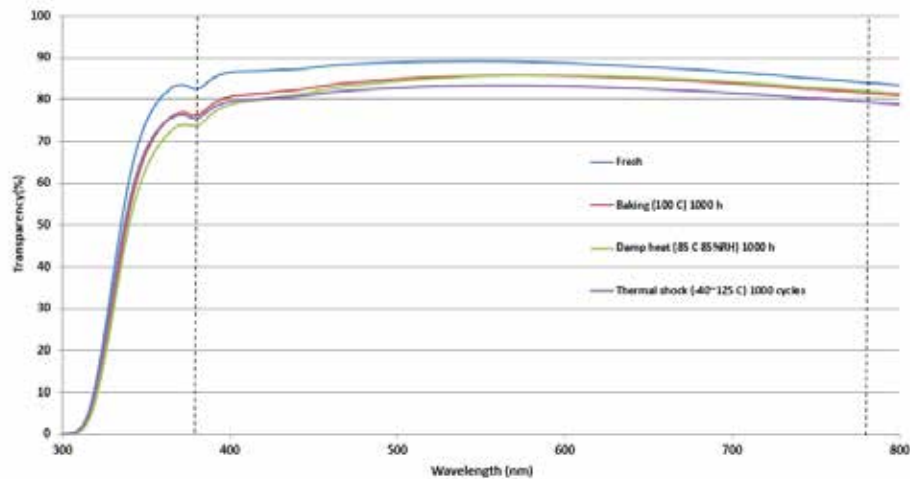

FIG. 3 Measurement of transparency after several ageing tests. Dashed lines indicate the range of visible light for the human eye (380-780nm).



FIG. 4 Transparent Structural Sealant after 10000 hours UVA exposure

3.1.2 Cure behavior and initial tack

The clear silicone 2400 is a 100 % silicone neutral-cure mono-component adhesive. The cure is obtained by reacting with moisture in the atmosphere. Figure 5 shows faster cure rates with increasing temperature and relative humidity, as is typical with mono-components. However, thanks to the use of a polysilicate resin in the formulation, adhesion starts with instant initial tack which is much higher than standard structural sealants. The initial tack is determined by measuring glass-glass H-piece adhesion strength at 6 mm/min (Figure 6). Whereas only 300 Pa initial tack is measured at the time of application for mono-component structural glazing sealant (Dow Corning, 2016 b), more than 10.000 Pa is developed by the 2400 sealant. With its >30 times higher initial tack, it provides a significant advantage in handling safety. After 24 hours, both technologies reach about 0.2 - 0.4 MPa. This strength is in theory enough to handle and ship glued units. However, moving a unit glued with a mono-component structural glazing sealant before its full cure can lead to macroscopic distortions and separations between the cured and uncured phases. The polymer network would not be able to develop in an optimal way and the final properties of the cured sealant will be much less than in normal curing conditions without movement. On the other hand, the polysilicate resin significantly increases the cohesive strength of the hot melt formulation such that the sealant bead maintains its mechanical integrity during transport, which ensures optimal final strength properties. Thanks to this effect, units glued with 2400 sealant can be shipped after 24 hours and productivity improvements can be obtained. At 4 weeks room temperature (RT) cure, a maximum engineering stress of 1.8MPa is reached.

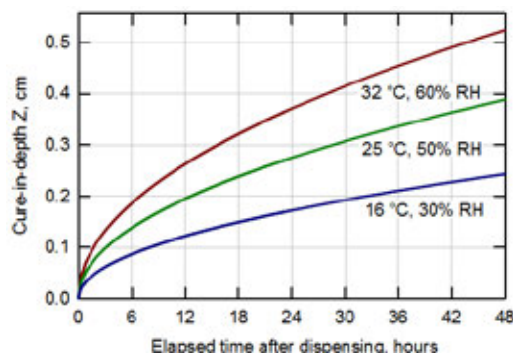

FIG. 5 Cure in depth (cm) of 2400 sealant with varying temperature and relative humidity conditions

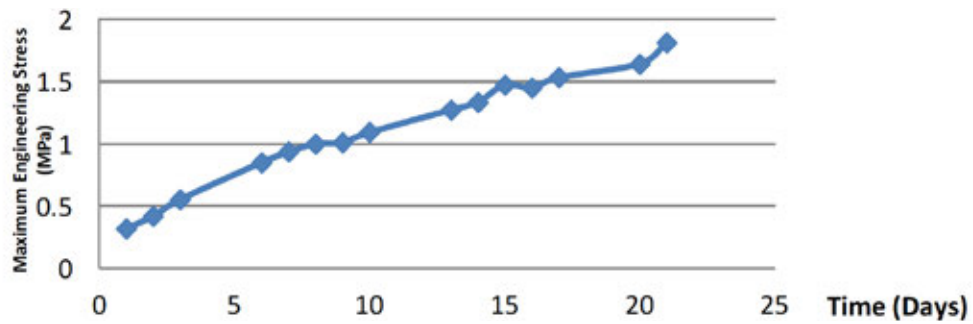

FIG. 6 Adhesion build up (maximum engineering stress in MPa) in tension of 2400 glass-glass H-pieces (12 x 3 x 50 mm³). Pulling speed 6mm/min

3.1.3 Dynamic load behavior

The stress-strain values for the 2400 were measured on 12 * 12 * 50 mm H-pieces and dynamic load (6mm/min). After 4 weeks at room temperature RT, a maximum tensile strength of 1 MPa was measured. In the case of dynamic short duration loading such as normal wind load stress, a safety factor of 6 is typically used in Structural Glazing (EOTA, 2005). This results for 2400 in about 0.16 MPa dynamic design load. However, since the measured forces are in the same order of magnitude as structural sealants, the same design dynamic strength of 0.14 MPa was selected. This design load corresponds with a slightly higher safety factor (7 instead of 6) than for structural glazing sealants.

3.1.4 Static load behavior

In order to evaluate the static load resistance of the 2400, lap shear samples of 15x30x2mm³ were realized and cured 4 weeks at RT. The samples were subsequently exposed to high temperature 60°C and humidity conditions (85%) under permanent static stress. A maximum stress of 0.033MPa has been applied since more than 3months without movement.

A safety factor of 4 was chosen to determine the static design strength of 0.008MPa.



FIG. 7 Evaluation of static load resistance of 2400: lap shear samples (15x30x2mm³) exposed to high temperature (60°C) and high RH (85%) under permanent stress

3.1.5 Durability

Durability tests following ETAG002 procedure were performed on 4 weeks cured 2400 H-pieces. Exposure to UV for 10.000 hours did not result in loss of dynamic strength (0.99MPa instead of 1MPa). Immersion for 6 weeks in 45°C hot water increased the tensile strength to 1.15MPa, whilst the immersion for 3 weeks in 55°C water led to a tensile strength of 1.13MPa. Immersion in hot water can lead to further post-cure of the silicone, which is typically not observed when curing at room temperature. With one part curing silicone diffusion of moisture is the rate limiting factor. When exposed to high temperature and humidity a more in depth crosslinking can occur and improve mechanical properties of the material.

The extreme dynamic load resistance of the 2400 sealant was evaluated by performing cyclic testing representative of hurricane exposure. Therefore monolithic laminated glass was bonded in a 1.2 by 1.8 m aluminum frame using 12.7 mm 2400 joint. The unit was subjected to cyclic static pressure differential loading based upon ASTM E1886 (ASTM, 2013). The test could not be passed when using previous versions of the hot-melt technology, due to bad elastic recovery. However, units bonded with 0.51 mm bondline of the latest developed 2400 sealant passed 9000 cycles at ± 3800 Pa. Deflections from center of glazing of 8 mm or 6.4 mm were measured during positive respectively negative cycling.

3.1.6 Additional features and benefits

The hardness reaches 60 on the A scale. The sealant is comparatively elastic, reaching an ultimate elongation of more than 100 % according to ASTM D412 (ASTM, 2015) and has an allowed movement capability of +/-50 % according to ASTM C719 (ASTM, 2014). Due to this doubled movement capability and elasticity in comparison with structural sealants (25%), thermal elongations between different materials (e.g. glass and aluminium) can be allowed with half the silicone thickness normally required. Whereas structural glazing requires a minimum joint of 12 by 6 mm², a silicone 2400 joint of 10 by 3 mm² may be recommended to resist the loads typically occurring in structural glazing applications. However a case by case evaluation might prove to be necessary and a correct filling of the joint will need to be verified. Independently of the thickness of the joint, mechanical properties will remain the same. The clear silicone 2400 sealant develops primerless adhesion to glass and anodized aluminum as well as a variety of other substrates (e.g. stainless steel, PVC etc).

3.2 APPLICATIONS

3.2.1 Crystal clear structural glass connections

Although additional testing is needed, the above presented results have indicated the potential capacity of the clear 2400 technology to fulfill the role of a traditional structural glazing sealant. The combination of strength and transparency in conjunction with high movement capacity might be especially attractive for glass beams, decorative glass bonding, double skin façades or glassfin applications.

Glassfins are typically bonded to the face glass along the height (long dimension) with a black structural sealant whilst the top and bottom of the glassfin is mechanically fixed in a U channel profile. Therefore in this kind of application the joint is only subjected to dynamic wind loading and no deadload making it an ideal application where 2400 sealant could bring a clear aesthetic advantage. Glassfin dimensions of 30 mm thickness are typical. In order to respect the ratio between width and thickness of the joint, a thickness of 10 mm would typically be applied. The full width of 30 mm will not always be filled with black silicone, but the use of a middle backerrod could be further to the detriment of the aesthetics. Switching to clear 2400 means the thickness could be significantly reduced without using a backerrod. Aesthetic effects as illustrated in the figure 8 can be achieved.



FIG. 8 Aesthetics in glassfin fixation using transparent structural silicone adhesive

3.2.2 Crystal clear secondary seal

Architectural trends tend towards larger glasspanes increasing transparency and light of the façade. However, the use of a black primary and secondary sealant in the insulating glass unit (IGU) edges prevents obtaining completely transparent units. The use of 2400 technology could improve this situation partially.

On top of the mechanical properties before and after ageing, the water vapor transmission rate (WVTR) is one of the essential parameters to ensure the durability of an IGU.

The water vapor transmission rate of the clear 2400 adhesive was measured according to EN 1279-4 (EN, 2002). An average permeability of 14.9 gr/24h.m² was measured on 2 mm thick membranes (INISMA, 2016). This represents an improvement of up to 30 % in comparison with a non clear structural mono-component sealant used in IGU applications (IFT, 2007) and 15 % improvement in comparison with a non-clear structural bi-component sealant (INISMA, 2013).

To further enable and harness the technical and architectural advantages of the 2400 adhesive, its use on a façade can be combined with other optically clear materials to provide backing or act as a spacer, whilst still being transparent. First trials of manufacturing transparent spacers and gaskets have been made with clear, optical grade moldable silicones. These silicones have specifically been formulated for the lighting industry where they are, for example, being injection molded in 3D shapes such as lenses or led luminaires. Their specific formulation ensures high temperature, UV and weathering resistance without yellowing and guarantee perfectly clear views. Furthermore their scratch resistance is excellent, making it easy materials to handle in a factory (De Buyl, 2014).

First trials (figure 9) have been performed whereby a clear spacer and the clear silicone 2400 were used on the verticals of the insulating glass units where the clarity of both materials allows pure transparency. On the horizontal top and bottom a traditional insulating glass design is used, with a metallic spacer containing desiccant, butyl and a silicone secondary sealant. The risk of condensation and glass corrosion needs to be addressed by calculating the maximum moisture loading for the desiccant allowable over a certain period. However to get to a long-term durable solution, more research and development needs to be done to get an almost gas-tight primary sealant. So far crystal clear designs in IG are limited to certain niche applications for exterior and interior clear glass designs.

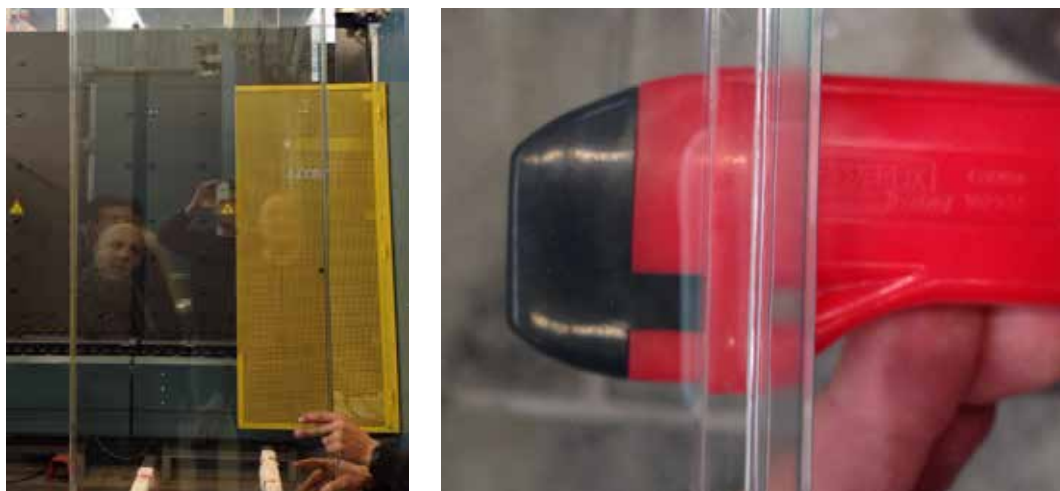

FIG. 9 First prototype of insulating glass unit using the clear 2400 on the verticals

3.2.3 Crystal clear weatherseals

Using the 2400 as a weatherseal to increase the transparency of a curtain wall seems to be an obvious application. Butt joints sealing 2 monolithic glasses provide a unique transparency. As the silicone is suitable for interior and exterior applications with a good UV-, temperature and weather-resistance, it opens many opportunities to connect glass to glass or glass to metal. Good examples are double skin facades or closed cavity facades, where a floating and clear aesthetics can be achieved combining structural properties and weather sealing function.

3.3 CONCLUSION

As silicone-based structural glazing solutions have gained an ubiquitous role in the modern commercial architectural realm, we can see that the technology and its application have evolved to address the challenges brought forth by more sleek and transparent facade designs. Designs that, in many instances, can only be realized with clear silicone bonding solutions. The unique combination of solutions comprises higher design load capacity, a high movement capability to accommodate joint movement paired with the higher instant strength enhancing handling and productivity. It opens new design options and fabricator benefits all to produce a more visually understated transparency on behalf of well stated architectural design intents.

References

- Sitte, S., & Brasseur, M. (2011). Preliminary Evaluation of the Mechanical Properties and Durability of Transparent Structural Silicone Adhesive (TSSA) for Point Fixing in Glazing. *Journal of ASTM International*, Vol. 8, No. 10, 2011, pp. 1-27.
- EOTA (2005). Guideline for European Technical Approval for Structural sealant glazing kits, Part 1: supported and un-supported systems
- IFT (2011). Test report n 11-000515-PR01
- Sadev (2016). Sadev website for more information see www.sadev.com
- Dow Corning (2016). Silicone Structural Glazing Manual. Retrieved from Dow Corning website. For more information see: <http://www.dowcorning.com>
- Santarsiero, M., Louter, C. & Nussbaumer, A.: The mechanical behaviour of SentryGlas® ionomer and TSSA silicon bulk materials at different temperatures and strain rates under uniaxial tensile stress state. *Glass Structures & Engineering* (2016) Vol. 1, issue 2, pp 395-415. doi:10.1007/s40940-016-0018-1
- Hautekeer, J-P., & Plettau, M. (2005). New Bonding Technologies for Window Glazing and Assembly Bring Benefits Throughout the Entire Industry Value Chain. *Proceedings of Glass Processing Days 2005*, pp. 219-225
- ASTM (2013). ASTM E1866, Standard Test Method for Performance of Exterior Windows, Curtain Walls, Doors, and Impact Protective Systems Impacted by Missile(s) and Exposed to Cyclic Pressure Differentials
- ISO (2001). ISO 15368:2001 Optics and optical instruments -- Measurement of reflectance of plane surfaces and transmittance of plane parallel elements
- ASTM (2012). ASTM C1648-12, Standard Guide for Choosing a Method for Determining the Index of Refraction and Dispersion of Glass
- Dow Corning (2016b). Dow Corning® 895 structural glazing sealant. Retrieved from Dow Corning website. For more information see: <http://www.dowcorning.com>
- Burr, A. & Cheatham, J. (1995). *Mechanical Design and Analysis*, 2nd Ed. New York: Prentice-Hall.
- ASTM (2015). ASTM D412, Standard Test Methods for Vulcanized Rubber and Thermoplastic Elastomers-Tension
- ASTM (2014) ASTM C719, Standard Test Method for Adhesion and Cohesion of Elastomeric Joint Sealants Under Cyclic Movement (Hockman Cycle)
- EN (2002). EN 1279-4, Glass in building. Insulating glass units. Methods of test for the physical attributes of edge seals
- INISMA (2016). Test report n 2016B MAS 26887
- IFT (2007). Test report n 655-32769/1e
- INISMA (2013). Test report n 2013B VEC 17502-3a
- De Buyl, F., & Al, J. (2014). Dow Corning® Moldable Silicone Leading Innovations in LED Light Fixtures. *The Society of Silicon Chemistry Japan*, 2014, pp. 23-38.

GFRP Reinforcement and Anchorage Concepts for filigree Energy-Efficient Façades made of UHPC

Milan Schultz-Cornelius¹, Matthias Pahn²

- 1 TU Kaiserslautern, Institute of concrete structures and structural engineering, Paul-Ehrlich-Straße Building 14 Room 545, 67633 Kaiserslautern, Germany, tel. no. +49 631 205-5496, fax. no. +49 631 205- 3555, milan.schultz-cornelius@bauing.uni-kl.de
- 2 TU Kaiserslautern, Institute of concrete structures and structural engineering, Paul-Ehrlich-Straße Building 14 Room 557, 67633 Kaiserslautern, Germany, tel. no. +49 631 205-3083, fax. no. +49 631 205- 3555, matthias.pahn@bauing.uni-kl.de

Abstract

Large-size façade elements are mainly produced as non-load bearing precast concrete elements, which emerged together with the frame construction in the 1920s. Since 1960, such elements are also used as facing panel for sandwich walls, either with or without a subsequent layer of in-situ concrete. Both types of façade systems can be produced with a large size. A thickness of 7 to 10 cm is necessary to protect the steel reinforcement against corrosion. Innovative developments in the field of construction materials enable the realisation of energy-efficient architectural façades with a thickness of a few centimeters. Consequently, CO₂, transport costs and base area can be saved. The applied ultra-high performance concrete possesses a compressive strength of more than 150 N/mm² as well as a flexural tensile strength of up to 20 N/mm². As reinforcement and anchoring elements glass fibre reinforced polymers are used. These allows a permanent mounting at the support structure without thermal bridges. The design of the façades takes place on the basis of experimental results of tests with single components. This has to be questioned especially with regard to filigree façade systems. The testing of single components does not take into account the multi-axial load-bearing behaviour, the real component dimensions or the stiffness of the substructure. In order to integrally test different façade elements, a special test stand has been developed at TU Kaiserslautern. The test stand enables the simulation of a temperature and a wind load. With the aid of an optical 3D-deformation analysis system, the deformation can be measured with a precision of up to 20 µm/m. The brittle fracture can be recorded with a high-speed camera. This paper particularly presents four different façade systems as well as the façade test stand and experimental results.

Keywords

Keywords: UHPC, GFRP, energy-efficient façade, façade test set-up



1 INTRODUCTION

1.1 GENERAL

A façade defines the external appearance of a building. It is the outer shell of a building separating the interior space from the outside and protecting against the weather without a static function. Depending upon the usage, it is distinguished between the following construction options during the planning of façade elements. The dimensions of these concrete façade systems vary according to their application. They are used as thick curtain-wall facings with surfaces up to 30 m² or as sandwich wall panels with a minimum thickness of 7 cm. This minimum thickness results from the concrete cover required to protect the steel reinforcement against corrosion. Façades usually do not have any static requirements. Nevertheless, a minimum reinforcement is demanded in order to ensure a ductile structural performance. Another field of application is as unreinforced cast-stone façades with a minimum thickness of 3 cm. The surface area of these cast-stone façades is mostly less than one square meter owing to their low flexural tensile strength that has to be considered for structural verification purposes. These Facades do not feature a ductile behaviour or a residual strength after cracking. The necessary level of safety is regulated with safety factors and permissible material parameters. The different types mentioned are shown in Fig. 1.

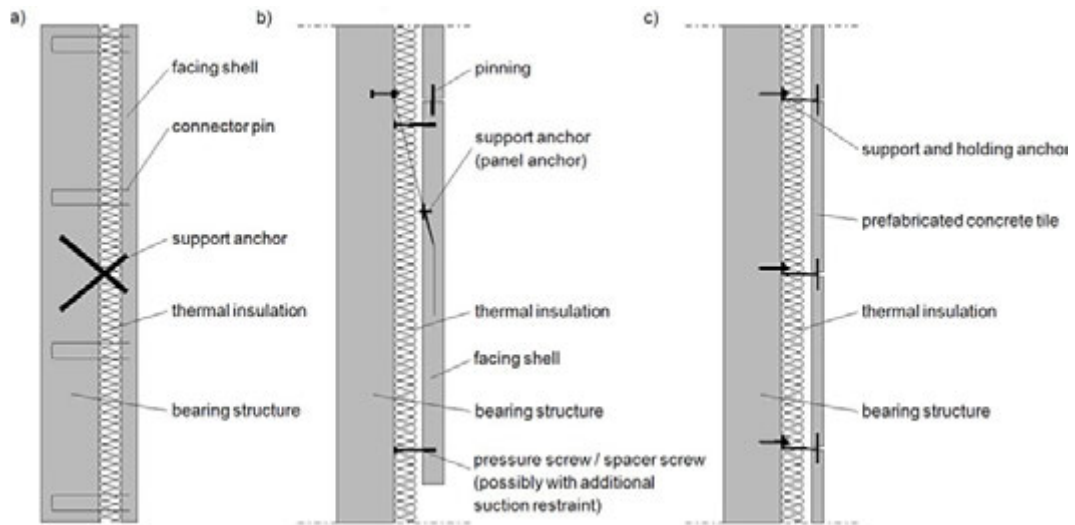

FIG. 1 left: sandwich wall; middle: curtain-wall facing; right: cast-stone façade

1.2 AIM OF THE INVESTIGATIONS

Many architects develop ambitious design ideas and are desperately looking for a combination of the advantages of the existing systems, meaning a system that would provide an architectural concrete façade composed of large, slender panels. However, such combined sandwich wall systems would incur high costs as well as many joints and would be subjected to limitations imposed by currently applicable codes and standards. A new system would provide the following advantages:

- reduction in CO₂ emissions due to less material and thus cement savings
- larger usable base area within the building
- less demanding specifications for fasteners, thus reducing their number and potential thermal bridges
- reduction in transport costs and usage of smaller lifting equipment

New materials like ultra-high performance concrete and non-corrosive reinforcement allow to reduce the thickness of façades without scaling down the size of the elements. As a result, they can be used as curtain-wall facings or as facing for sandwich walls. The system will be realized as a punctually supported slab, like most of the façades, in order to take advantage of the multiaxial load bearing behaviour. Therefore, a ultra-high performance concrete is used as well as bar-shaped anchoring elements consisting of glass fibre reinforced polymers, which are distributed all over the façade area (Fig. 2). They enable the connection to the load bearing structure without causing thermal bridges.

Because of the anisotropic material properties of the glass fibre reinforced polymers, tension and compression loads resulting from wind or temperature can be carried with low deformations. On the other hand there is low resistance against deformation restraint within the plate plane caused by temperature deformation, which minimizes the cracking of the façade. Various materials can be used as reinforcement, such as short fibres, textile or bar-shaped reinforcement. While all types of reinforcement possess individual advantages and disadvantages, they share one important design basis: architecturally high-quality, non-load bearing concrete façades are supposed to be free from cracks. The presented investigations concentrate on the bar-shaped reinforcement commonly used in precast factories as well as in unreinforced concrete façades.

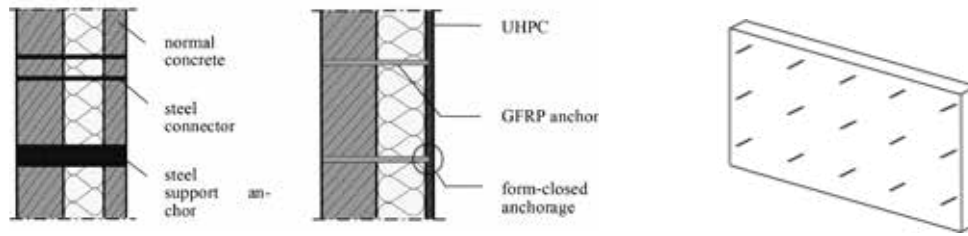

FIG. 2 left: normal sandwich wall; middle: UHPC sandwich wall; right: anchoring concept for UHPC sandwich wall

2 MATERIALS

2.1 ULTRA-HIGH PERFORMANCE CONCRETE

Ultra-high performance concrete consists of many fine-grained components such as silica fume, which is difficult to be stocked up and to be managed in practice. Furthermore, special high performance mixers and long mixing times are necessary. For this reason the façade is produced with the binder premix Dyckerhoff NANODUR® Compound 5941. This premix consists of 59 % cement NANODUR® CEM II/B-S 52,5 R and 41 % quartz powder. It is homogenized at the cement factory and consequently it can be mixed with conventional methods. Additionally, it contains less portland cement, which improves its CO₂ balance (Deuse, T., Hornung, D., Möllmann, M., 2009). The aggregates are dried sand 0/2 mm and basalt 2/5 mm. The precise composition is displayed in Table 1.

The fresh concrete properties of the self-compacting concrete are tested according to DIN EN 12350-6 (2011), DIN EN 12350-7 (2009) and DIN EN 12350-8 (2010). The results are shown in the following Table 2.

MATERIAL	RAW DENSITY OF THE MATERIAL	WEIGHT
NANODUR® Compound 5941	2.860 kg/m ³	1.066,5 kg
Sand 0/2 mm	2.650 kg/m ³	436,7 kg
Basalt 2/5 mm	3.060 kg/m ³	893,8 kg
Plasticizer Glenium ACE 430	1.060 kg/m ³	14,1 kg
Water	1.000 kg/m ³	156,8 kg

TABLE 1 Concrete composition for 1 m³

PROPERTY	UNIT	VALUE
Slump flow measure after 30 seconds	cm	55 / 55
Slump flow measure after 60 seconds	cm	62 / 64
Air void content	%	1,20
Fresh concrete temperature	°C	23,50
Room temperature	°C	22,40
Raw density	kg/dm ³	2,43

TABLE 2 Fresh concrete properties

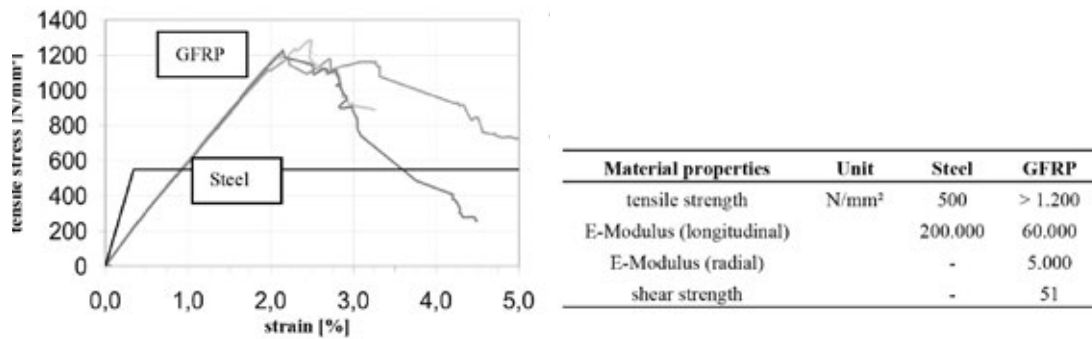

FIG. 3 left: stress-strain diagram; right: material properties of GFRP and steel

2.2 GLASS FIBRE REINFORCED POLYMERS

As anchoring elements and as reinforcement established products made of glass fibre reinforced polymers are used. The bar-shaped anchor element Schöck Thermoanker® TA-H and the reinforcement Schöck ComBAR® are applied, both consisting of the same material. The stress-strain-diagram shown in Fig. 3 illustrates the linearelastic material behaviour up to failure.

While the glass fibre reinforced polymer possesses a high tensile strength, the modulus of elasticity is low compared to steel (Fig. 3). Another important material property is the corrosion resistance. Based on this, the concrete cover can be reduced to the minimum, which is necessary to bear the bond loads.

3 EXPERIMENTAL INVESTIGATIONS

3.1 GENERAL

The experimental program aims to investigate the influence of different reinforcing concept. It is distinguished between the two borderline cases of an unreinforced façade and the usage of the minimum reinforcement. Beside both of them two further reinforcing concepts are investigated. The following questions have to be answered:

- Which reinforcing concepts achieve a ductile structural performance?
- To what extent the load-bearing capacity of the façade can be increased?
- Does the reinforcement influence the crack initiation?

3.2 SPECIMEN

Generally, the specimens consist of the façade layer, a hollow space that corresponds to the layer of thermal insulation and the load bearing layer. It is important to exclude the thermal insulation, because a free space is needed, where negative pressure can be generated. The connection between load-bearing layer and UHPC-façade is realized by GFRP fasteners. Altogether four specimens are produced. The specimens, which are shown in Fig. 4, feature a size of 1.3 m x 1.3 m.

The UHPC-façade has a thickness of three centimetres and is connected with nine fasteners with a nominal diameter of 12 mm. One of the specimens is unreinforced while the others possess a bending reinforcement with Schöck ComBAR® ø8mm. Each specimen has a gap for the thermal insulation of 20 cm. That represents the usual maximum thermal insulation thickness. In Table 3 the mechanical and geometric properties of all specimen are shown as well as the different reinforcing concepts. Specimen V1 is unreinforced, specimen V2 is produced with the minimum reinforcement corresponding to Eurocode 2 (DIN EN 1992-1-1, 2011). This minimum reinforcement is successively reduced within V3 and V4. Specimen V3 possesses a stripe formed reinforcement in the area of the supports and specimen V4 has locally added reinforcement at the anchors.

The bending tensile strength R_f , which is shown in the table, is tested on prisms according to DIN EN 196-1, (2005) and is calculated by the average of three values.

POSITION	REINFORCING CONCEPTS	GEOMETRIC PARAMETERS [MM]							MECHANICAL PROPERTIES [N/MM ²]		
		ϕ	dx/dv	a/b	dvs	d_b	d_{TS}	a_1/b	$f_{cm,cube}$	E_{cm}	R_f
V1 Unreinforced		8	9,5/18,5	500	30	200	150	150	155,9	54000	14,1
V2 Minimum reinforcement		8	9,5/18	500	30	200	150	150	157,2	54000	14,4
V3 Stripe formed support reinforcement		8	9,5	500	30	200	150	150	149,9	54000	14,8
V4 Reinforcement at the anchors		8	9,5/18	500	30	200	150	150	148,9	54000	13,9

TABLE 3 Mechanical and geometric properties of the specimen

3.3 EXPERIMENTAL SETUP

In order to build up negative pressure an airtight hollow space has to be produced. Therefore the specimen is surrounded by a steel frame at all edges. The airtight case has openings to connect a vacuum pump, measure the air pressure and for cables of conventional measurement equipment. For the load application a high-performance vacuum pump is used to build up negative pressure, which represents a wind load. With a control unit the valves can be regulated. To generate a temperature load infrared heating units with a power of 3000 W are applied. Within this test series the specimens are only loaded with equally distributed loads up to the failure.

During the experiment the internal and external atmospheric pressure is measured permanently with calibrated manometers. Behind a safety glass the optical measurement system is placed. The system consists of a high-speed camera to analyse the failure mechanism and two cameras for optical 3D deformation measurement. The full experimental set-up is shown in Fig. 5. The 3D measurement is used with a resolution of 2448 x 2050 pixels and works with stereo correlation technique with a measuring speed of 1 fps. To analyse the failure mechanism of the façade a high-speed camera is used. The camera features a resolution of 1024 x 1024 pixels and a measuring speed of 5.000 fps.

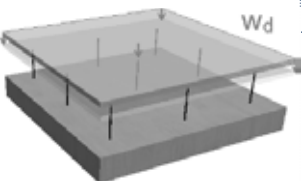
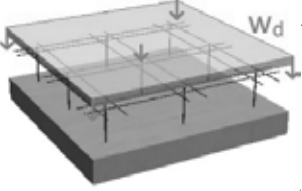
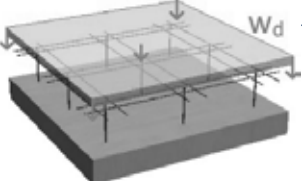
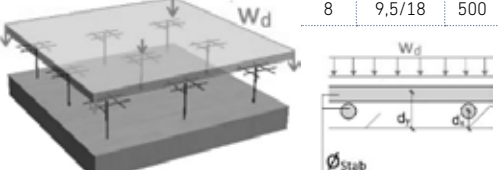
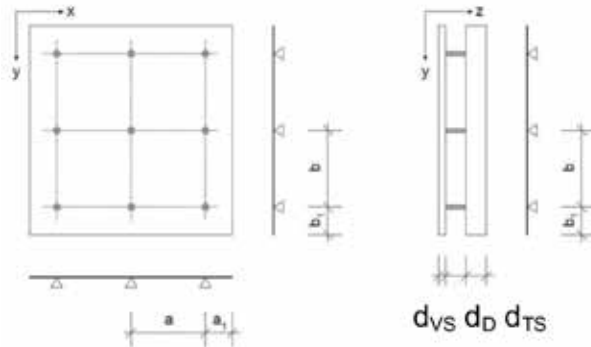

FIG. 4 Dimensions and static system of the specimens

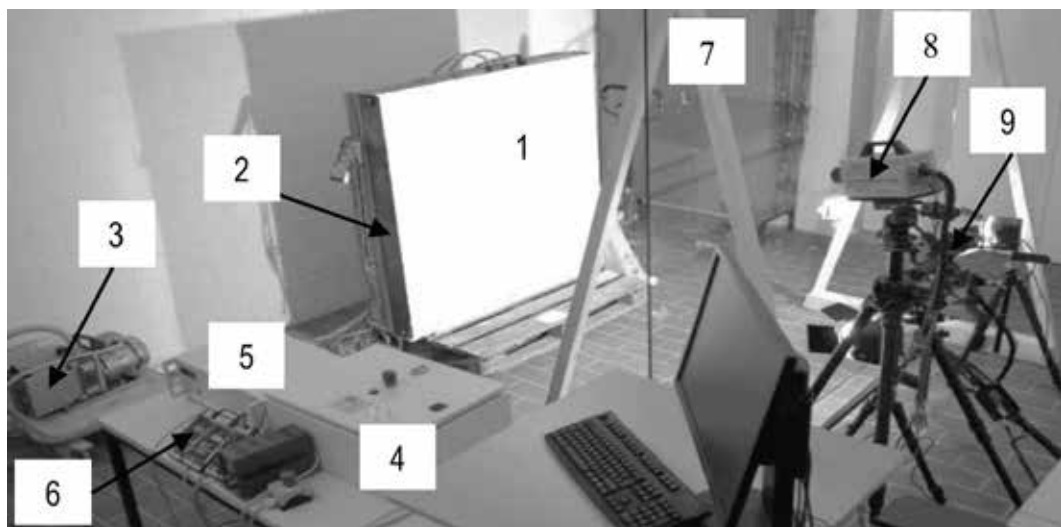

FIG. 5 Experimental setup: 1 specimen, 2 steel frame, 3 vacuum pump, 4 control unit, 5 measurement amp., 6 manometer, 7 safety glass, 8 high-speed camera, 9 3D measurement sys.

4 RESULTS

4.1 LOAD-DEFORMATION-DIAGRAM

The load-deformation-diagram shown in Fig. 6 illustrates the deformation at the centre of the span uz in dependence of the distributed load p during the vacuum experiment. All tests show a linear increase of the curve at the beginning. At a load level of circa 70 kN/m^2 a bending crack occurs at the unreinforced UHPC façade of the specimen V1, which initiates the failure of the façade. Afterwards an increasing deformation can be measured while the load stays at the same level. This plateau results from cohesion and crack keying and lasts to the failure of the specimen. At Specimen V2 the first crack occurs at a load level of circa 35 kN/m^2 . Subsequently, the crack formation continues up to the completed crack pattern. Then the deformations increases with the load-deformation-curve proceeding almost parallel to the x-axis. The specimen fails at a load level of 64 kN/m^2 . The specimen with a stripe formed support reinforcement V3 also shows a linear increase of the curve at the beginning until the first crack appears at 67 kN/m^2 . Afterwards a further load and deformation increase can be measured until a similar plateau to the one of specimen V2 occurs and the specimen fails at 84 kN/m^2 .

In comparison to the other reinforcing concepts, the structure performance of specimen V4 is slightly stiffer before the first crack occurs at 51 kN/m^2 . According to that the load-deformation-curve runs almost parallel to the one of specimen V3 and another increase of the load and the deformation can be seen until the failure load of 71 kN/m^2 is reached. In summary all specimens with reinforcement show lower initial crack loads. Especially with the minimum reinforcement a reduction of circa 50 % and a lower failure load can be observed. Compared to specimen V1, the failure load can only be increased with the help of a stripe formed support reinforcement. While specimen V2 shows a ductile structure performance the specimens V3 and V4 fail with a low deformation of less than 1 mm.

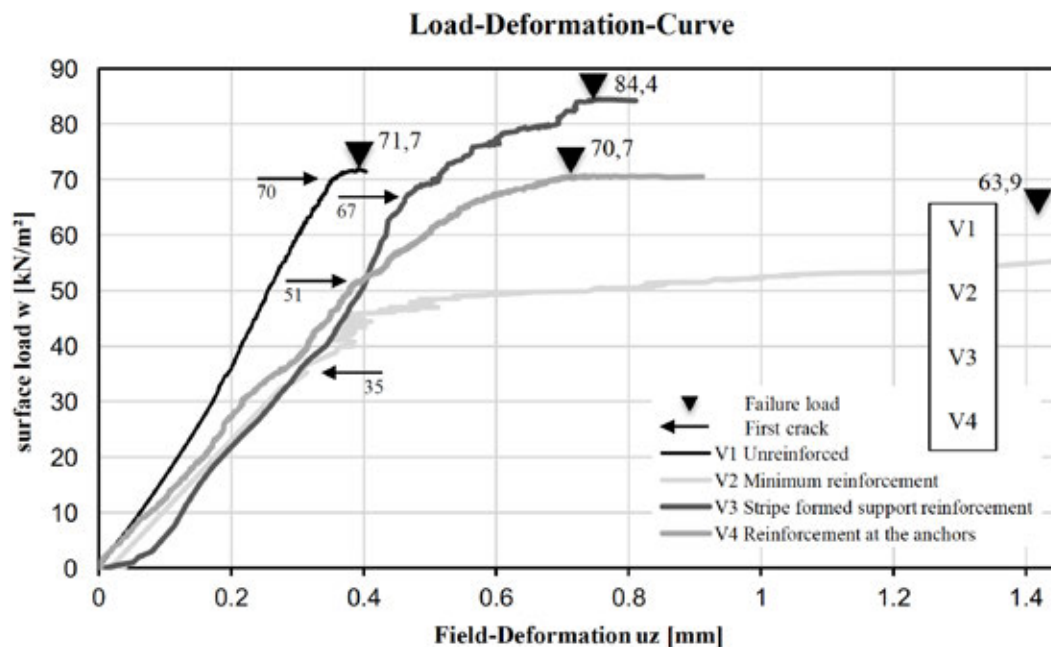

FIG. 6 Load-deformation-diagram

4.2 FRACTURE PATTERN AND FAILURE MECHANISM

The following Table 4 displays footage of the high-speed camera, the 3D deformation measurement system and the fracture pattern. Both the high-speed camera footage and the one of the photogrammetry show the moment of the failure of the façade. The fracture pattern demonstrates the specimen after its failure. With the help of the photogrammetry the main deformation can be visualized. The specimens V1, V3 and V4 feature a similar crack pattern. Bending cracks arise at the supports on the edges and a star-shaped crack pattern in the centre of the façade occurs. These cracks grow and partially connect until the specimen fails. Specimen V2 shows consistent horizontal and vertical cracks instead.

With the help of the corresponding footage of the high-speed camera the failure mechanism can be identified. The failure of specimen V1 is caused by an end-to-end horizontal bending crack. It starts at the edge positioned anchors and passes the centre anchor. At specimens V3 and V4 the anchors punch through the façade. The images show concrete cones over the centre supports.

The fracture patterns of the single specimens are different. At specimen V1 several single fragments occur. They are wedged and held by the steel frame. At specimen V2 the minimum reinforcement prevents the façade from falling apart. All of the anchors punched through the façade and hold it. The façade of specimen V3 is almost completely destroyed. The fracture pattern of specimen V4 is a mixture of the ones of V1 and V3







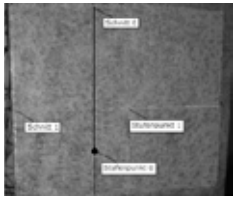

SPECIMEN / FAILURE MECHANISM	PHOTOGRAMMETRY	HIGH-SPEED CAMERA	FRACTURE PATTERN
V1 Bending crack			
V2 Bending cracks and punching anchors		NOT RECORDED	
V3 Bending cracks and punching anchors			
V4 Bending cracks and punching anchors			

TABLE 4 Results of cracks, Failure mechanism and fracture pattern

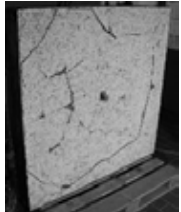
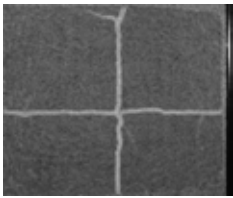
5 CONCLUSION

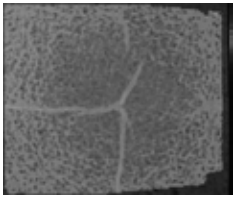
The experimental investigations show that a ductile structure performance can only be achieved by the minimum reinforcement according to Eurocode 2 (DIN EN 1992-1-1, 2011). All other specimens fail at a deformation level of less than 1 mm. It is specifically interesting that the deformations of the specimens V3 and V4 hardly differ from the unreinforced façade. All of the specimens fail at a high load level. While the initial crack load of the unreinforced façade almost conforms to its failure load, it is different with the reinforced specimens. The fully reinforced façade possesses the lowest load-bearing capacity but a high ductility. Also the crack initiation occurs earlier, which is an important factor for exposed concrete façades. This can be reasoned by the interrupted concrete tensile zone. The reinforcement acts like an imperfection within the concrete and reduces the concrete cross section causing its early failure. The same reason finally leads to the anchors punching through the façade at a lower load level compared to the specimens V3 and V4.

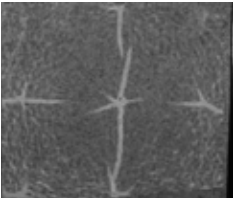
Specimen V3 reaches a significantly higher failure load of 84 kN/m^2 , which is 18 % higher than the one of the unreinforced specimen V1, effected by the stripe formed support reinforcement. The initial crack load has the same amount as the one of specimen V1. Thus the stress is diverted from the concrete to the reinforcement. At the same time, the reinforcement operates as a dowel and connects both of the crack edges.

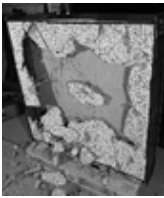
The stripe formed support reinforcement leads to a medial initial crack load and failure mode compared to the specimens V2 and V4. This contradicts the theory that the extent of reinforcement in this test series significantly influences the value of the initial crack load and the failure load. But it was also noticed that the reinforcement could not be positioned the way it was planned. It shifted during casting of concrete and might have touched the anchors, leading to a locally reduced concrete cross section (Fig. 7). This reinforcing concept seems to be inappropriate because of the difficulties in practicability, even though better results might have been achieved.

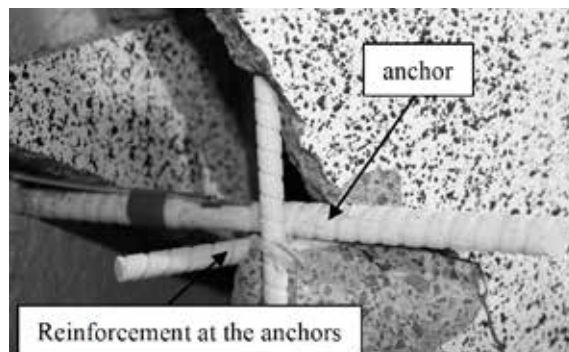

FIG. 7 Support detail of specimen V4

Further investigations concentrate on large-size unreinforced façade elements, because the initial crack load, which is significant for the calculation, could not be increased by any of the reinforcing concepts. Additionally, a ductile structure performance could only be achieved by a fully reinforced façade, also causing the lowest load-bearing capacity within the test series. The unreinforced façade reaches the highest initial crack load, approximately conforming to the failure load, and also shows advantages at the production, the recycling and the cost efficiency. Additional investigations focus on the development of a calculation approach, because currently no economical and realistic failure load can be calculated (Pahn, M., Schultz-Cornelius, M., 2014). Besides, another important factor is the exact determination of the material parameters, also taking into account effects such as size effect (Schultz-Cornelius, M., Pahn, M., 2016) and aging due to temperature, moisture and freeze - thaw cycling, which are currently investigated.

Acknowledgements

The work at TU Kaiserslautern is thankfully supported by Zentrales Innovationsprogramm Mittelstand (ZIM) of Bundesministeriums für Wirtschaft und Energie as well as by different companies of the construction sector.

References

- Deuse, T., Hornung, D., Möllmann, M. (2009). From Mikrodur to Nanodur technology. Sonderdruck BFT Internati International 05/2009, Bau Verlag
- DIN EN 12350-6 (2011). Deutsches Institut für Normung: Prüfung von Frischbeton – Teil 6: Frischbetonrohddichte. Berlin: Beuth Verlag.
- DIN EN 12350-7 (2009). Deutsches Institut für Normung: Prüfung von Frischbeton – Teil 7: Luftgehalt – Druckverfahren. Berlin: Beuth Verlag.
- DIN EN 12350-8 (2010). Deutsches Institut für Normung: Prüfung von Frischbeton – Teil 8: Selbstverdichtender Beton – Setzfließversuch. Berlin: Beuth Verlag.
- DIN EN 1992-1-1 (2011). Deutsches Institut für Normung: Bemessung und Konstruktion von Stahlbeton- und Spannbetontragwerken – Teil 1-1: Allgemeine Bemessungsregeln und Regeln für den Hochbau. Berlin: Beuth Verlag.
- DIN EN 196-1 (2005). Deutsches Institut für Normung: Prüfverfahren für Zement – Teil 1: Bestimmung der Festigkeit. Berlin: Beuth Verlag.
- Pahn, M., Schultz-Cornelius, M., (2014). Filigree Facades of (U)HPC. Proceedings of the 8th International Conference on Analytical Models and New Concepts in Concrete and Masonry Structures 16th -18th June 2014, Book of Abstracts, Full Paper on CD, Paper ID 30
- Schultz-Cornelius, M., Pahn, M. (2016). Investigations on the size effect of thin structural elements made of UHPC. Proceedings of the 4th International Symposium on Ultra-High Performance Concrete and High Performance Construction Materials 9th-11th March 2016, Book of Abstracts, Full Paper digital.

Thermal optimization of curtain wall façade by application of aerogel technology*

David Appelfeld¹

¹ Dow Corning Europe SA, Parc Industriel Zone C, rue Jules Bordet, B-7180 Seneffe, Belgium, tel. +32 499 049 500
David.Appelfeld@dowcorning.com,

Abstract

The paper illustrates the use of aerogel technology in façades to reduce thermal bridging and limit condensation. Additionally by mitigating local thermal bridges the indoor climate, especially draught and molds creation, can be eliminated as the surface temperature increases and prevents these negative factors. Curtain walls, in comparison to opaque wall, are often not designed in an energy efficient way and can be large contributors to heat loss of buildings. This is common for curtain walls in Asia and North America, where the energy requirements are not as demanding as in Europe. Building envelopes have many details which can easily introduce thermal bridge due to limited space of insulation or incorrectly solved construction detail. The heat flow through a poor thermally-performing detail, e.g. exposed concrete slab, could account for over 40% of the heat loss of the façade. The contribution of a well-insulated slab could be less than 10%. Unfortunately, traditional insulation techniques are often not suitable due to limited installation space. This paper discusses several case studies whereby the performance of a reference case is compared to a case with a thermally optimized façade implementing Building Insulation Blanket (BIB), which uses silica based aerogel technology. The thermal conductivity of BIB can be as low as 0.015W/mK, and together with its high flexibility and fire resistance enables new design possibilities. The use of BIB in the case studies, contributed to the reduction of overall curtain wall thermal transmittance up to 30%. Additionally condensation risk was significantly reduced.

Keywords

Aerogel, Building Insulation Blanket, Façade Thermal Breaks, High Performance Façade, Energy Efficiency, Curtain Wall Thermal Optimization

* Full paper published in JFDE / Journal of Façade Design and Engineering, Volume 5, Number 1, 2017.
DOI 10.7480/jfde.2017.1.1430

Fixed sunshade device for overhead glazing

Daniel Kleineher¹

¹ Dipl.-Ing. Architekt, M.Eng. Fenster und Fassade, kleineher+partner, Unterer Geisberg 12, 66121 Saarbrücken, Germany

Abstract

Gist of the lecture is a fixed solar protection system for overhead glazing consisting of intersecting Lamellae that form a grid structure. The structure is optimized to the geographical location and the installation situation. The maintenance-free system provides efficient sun protection combined with glare-free daylighting and free view outwards.

After a short introduction to the problem and a small insight into the history, the efficient operation of the sun protection grid is explained. The various applications in the macro, midi, micro and nano-range are shown. The micro region is most extensively explored at this time. This involves the use of optimized grid structure in the pane interspace (SZR) of insulating glass. The form-finding and the necessary parameters are explained. A selection of different grid structures is researched. Experimental measurements on prototypes include radiation-physical characteristics as well as the g-value measurements in a calorimeter. The results of these studies will be analyzed and transferred to simplified calculation methods. The analysis provides a broad image of the operation of the different geometries and the potential of this sun protection system.

The work shows that the fixed sunscreen grid system represents a sustainable solution in the field of glass roofs. The presented system is trademark protected in Germany and patent pending. The author seeks to develop the solar shading system further to market.

Keywords

Glass roof, fixed sunshade, grid of Lamellae, parametric design, solar characteristics, experimental research

1 SUNSHADE DEVICES FOR GLASS ROOFS

Summer heat insulation in recent years has become increasingly important and it is an integral planning task in energy-efficient buildings. The largest application for solar protection devices is located on vertical facades. Much of the available products are designed and optimized for this installation situation. Compared to vertical facades glass roofs are much more intensely exposed to the sun. The sun shines all day long on the roof surface from very different directions. The gross exposure to solar radiation during a year is therefore much higher than on facades.

Conventional solar protection systems are not sufficiently suitable for glass roofs. The sun protection systems available on the market are generally variations of the vertical application. There are, for example, mechanical systems, which are usually driven by a motor. The shading is ensured by movable fins or flat blinds. Because the path of the sun in the summer in central Europe describes an azimuth angle of 240 ° and more, the major mechanical systems must be completely closed or with fins regularly adjusted. Often, a clear view is considerably limited, the view to the outside is limited. Basically external systems offer a very good, internal systems offer a moderate sun protection (g-value). The mechanical-motor systems must be regularly serviced and maintained. Textile hangings have a strong tendency to become soiled and are quickly unsightly. The life of the textiles is limited. In case of stronger wind, these screens have to be retracted, a protection against unwanted energy gains and glare is no longer available.

Other options offer coatings and imprints of glasses. Using these methods, the g-value can be greatly reduced. Advantage of these systems is the freedom from maintenance and their use independent of wind. However, a direct radiation with corresponding cast shadow and contrast is present, which can lead to glare.

2 THE OPTIMIZED SUN PROTECTION GRID

2.1 ORIGIN AND DEVELOPMENT

The sun and glare protection system for glass roofs presented below, was first developed by the author as object-oriented solution to the problem described above with the following characteristics: effective sun protection, no direct solar radiation, high glare protection, no motor, no mechanics, no maintenance, high durability, weather-independent operation, nearly free view outward.

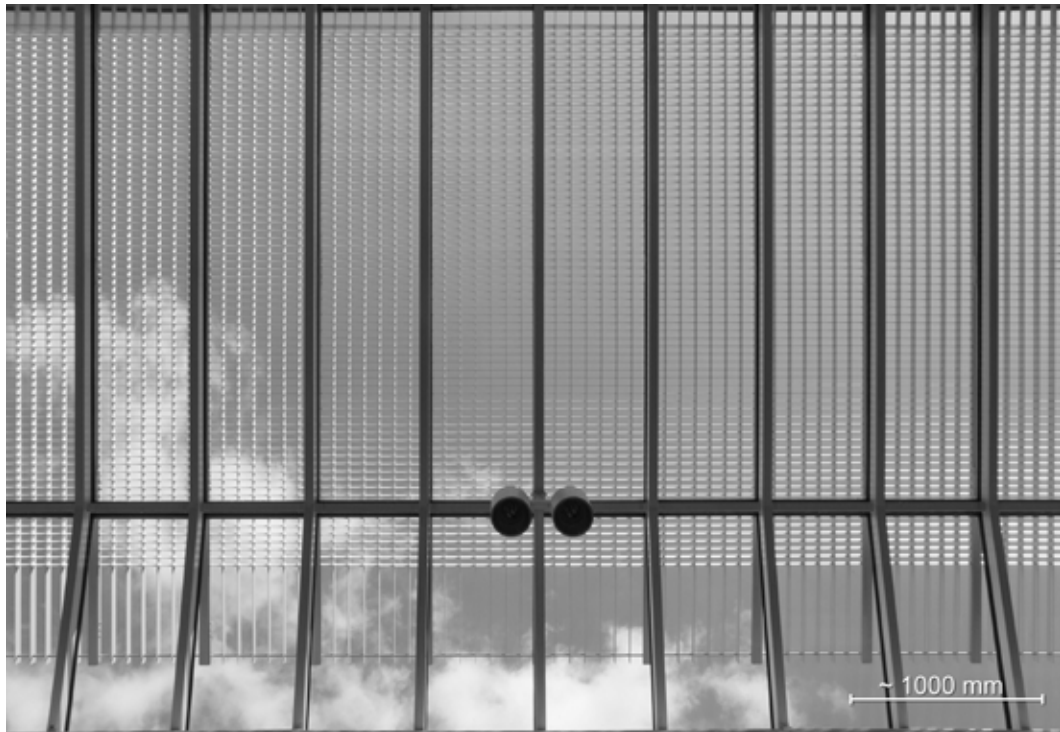

FIG. 1 Orthogonal grid geometry above a skylight, Dom- und Diözesanmuseum Trier 2008

The first application of the Dom- und Diözesanmuseum in Trier (Fig. 01) consists of orthogonal, intersecting Lamellae. Top and bottom of the grating are parallel and flat (Fig. 02). The grid consists of natural-anodized standard flat aluminum profiles which are taken in a retractable frame. The Frame is on the outside of the glazing and serves as a maintenance walkway for the glass roof. For cleaning purposes, the grids can be folded away. Typologically, this application belongs to the Midi-Structures.

The proportions of the grid cells are tuned in such a way that only during the apex of the sun at noon (June 21) around 10% of direct solar radiation pass into the interior. This creates a guaranteed highly efficient solar and glare protection. Combined with a double glazing without sunscreen coating a gtotal value of about 0,08 is achieved. With a triple glazing with solar control coating the gtotal value can be reduced even further. An open view to the sky is possible with complete effectiveness of the system (Fig. 01). The simple, efficient solar shading system displays its enormous potential.

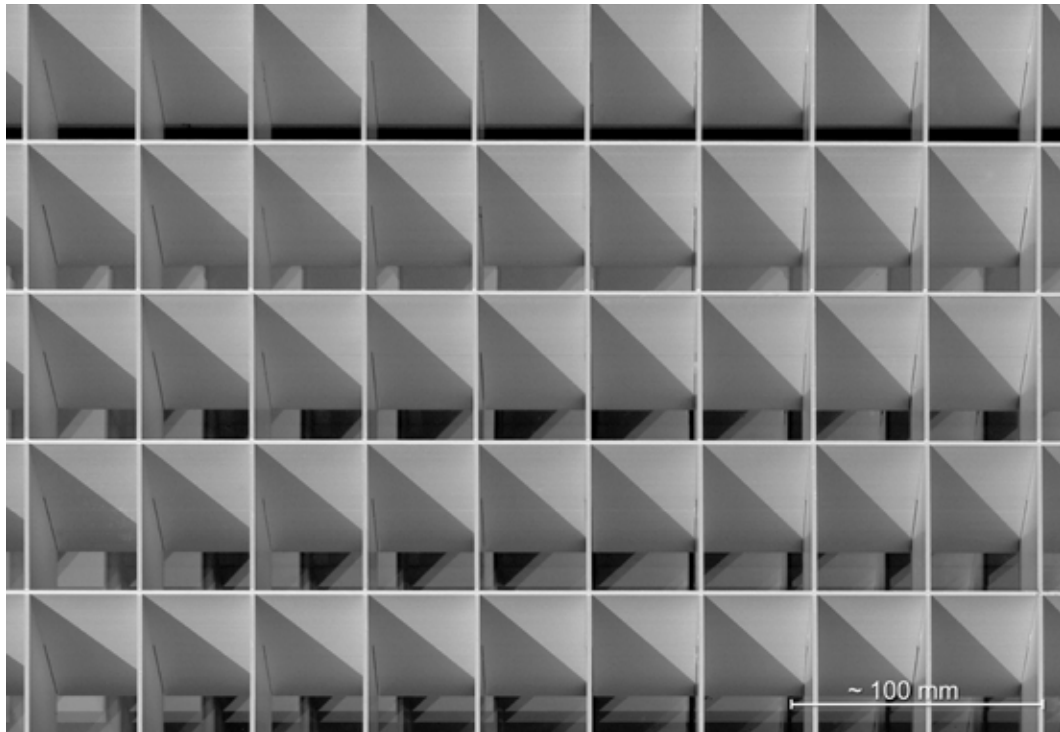

FIG. 2 Orthogonal grid geometry above a skylight usable as walkway, Dom- und Diözesanmuseum Trier 2008

Further development focuses primarily on integration of the grid structure in the pane interspace (SZR) of insulating glass units (Fig. 5). This offers significant advantages over an external grid structure. The material thickness of the Lamellae can be reduced to a minimum, because the lamella lying on a pane of glass, is not self-supporting and only need to be dimensionally stable. The cross bracing of the grid is achieved by the edge seal of the insulating glass pane. The relatively complex substructure with pivots, bearings and frames can be omitted. The accessibility of the outer sheets and cleaning are, without grid, no problem. The deadweight of the sunshade can be considerably reduced, even with a triple glazing. There is no need for the lamella material to be permanently resistant to corrosion or weatherproof, other materials can be used. Soiling of the lamella and deposits on the gratings, such as leaves are no longer possible. The cost of materials and thus the "gray energy" for the sun protection are considerably reduced, the assembly and deconstruction times are reduced noticeably, the external system is maintenance-free to 99%, the structure in the pane interspace to 100%.

However, a challenge is the production of filigreed grid structures. Because the number of the lamellae and the crossing points per square meter increases with increasing miniaturization, very high demands are placed on the precision of the lamellae and any addition of lamellae. An additional development objective therefore is to reduce the number of lamellae. This is achieved by tilting the transverse lamellae or the transverse and longitudinal Lamellae. Also a northward orientation of the individual lamellae (Fig. 03) can reduce the number of lamellae. Depending on production technology, trigonal geometries or hexagonal structures can also be applied.

The in-depth development and analysis of the system is also part of the Master's thesis of the author's degree in windows and facade of the University of Rosenheim, first examiner Prof. Dr. Franz Feldmeier, in cooperation with the Institute for Window Technology (ift) Rosenheim (Kleineher, 2013). There, different structures and materials studied in experimental measurements and compared by solar characteristics. The results of this master thesis are the basis of this contribution.

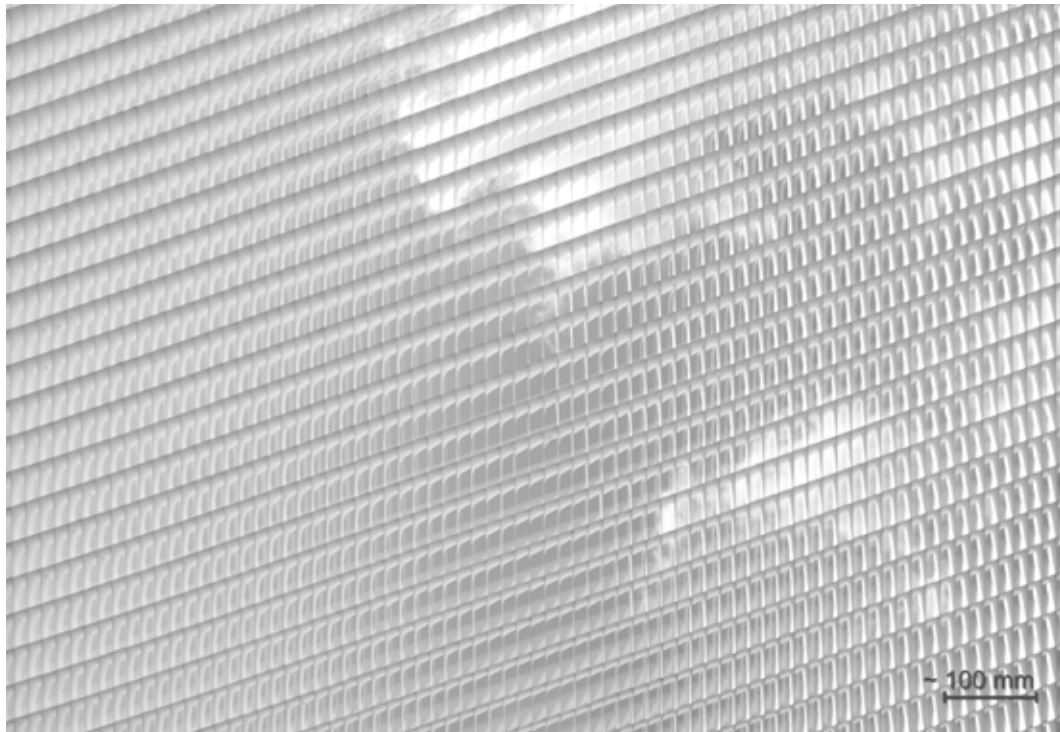

FIG. 3 parallel-shifted grid geometry (nord oriented Lamellae) in the upper pane interspace of a triple glazing, workshop building k+p, Saarbrücken 2014

2.2 MODE OF OPERATION

Hits sunlight onto a solar protection device, it will be reflected (radiated back), absorbed (taken up and converted into heat) or transmitted (allowed to pass). The grid geometries introduced here are designed to prevent direct solar radiation, i.e. direct transmission, throughout the whole year. On sunny days, this means that cast shadows in the interior are prevented and glare is greatly reduced. Light enters the interior only via multiple reflections of the Lamellae. The result is a very balanced light scattering. Thus, the incoming solar radiation is reflected and absorbed. Materials which are not completely opaque, e.g. Cardboard, also allow transmission through the Lamellae. Bright, non-metallic materials or surface coatings achieve high transmission values. The heat output of the grid due to absorption must be considered in the design.

On overcast days, diffused light can pass through the lamellae without obstruction. The amount of light is only slightly reduced, depending on the grid geometry. On sunny days, light transmission, direction of view and unobstructed view are also dependent on grid geometry.

The shading effect of the grid geometries can be well illustrated and verified with reference to ecliptic charts (Fig. 4). The lengthwise lamellae of type RB-01 N (Fig. 6) have a northward orientation, which allows for an optimal adaptation of the grid geometry to the solar cycle. The grid can also be designed to allow direct solar radiation to pass to a small degree at the time of the summer solstice around June 21. This has very little impact on the g-value, but improves the light transmittance on the whole, especially during the winter months. The ecliptic diagram shows very well the percentage and the period of direct radiation by way of an overlap of the shading graph and the ecliptic.

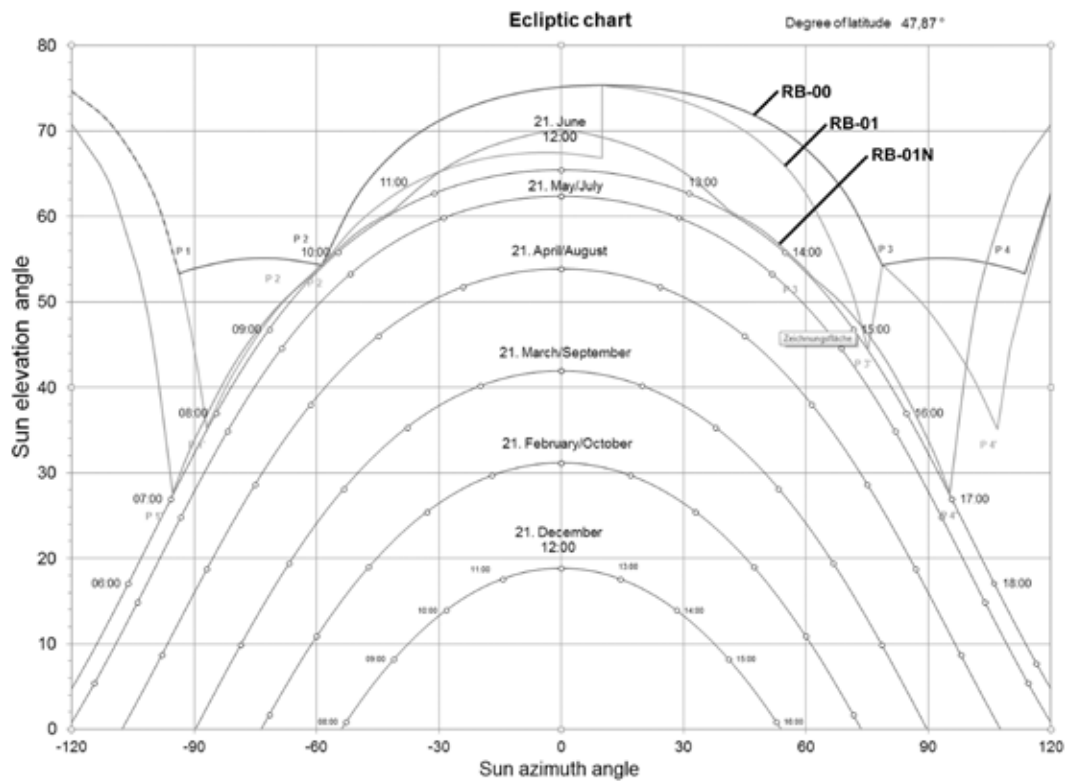

FIG. 4 Display of the shading effect of type RB-00, RB-01 and RB-01 N based on ecliptic charts (Kleineher, 2013)

Basically, the operating principle can be usefully applied to any location on the earth outside the tropics. Once the optimal basic proportions of a grid cell for any particular geographical location and installation situation is determined, the grid is endlessly scalable.

2.3 APPLICATIONS

In the applications, the author distinguishes between macro midi, micro and nano areas. The macro-area includes grid structures that can act as load-bearing structures simultaneously. Here, main and secondary beams are the lamellae. Where necessary, the structure's proportions adapt to curved surfaces. All common building materials can be used. If the supporting framework is placed outside the thermal envelope, the sun protection effect is very efficient. If it is placed inside, the heat absorbed by the grid can be used energetically, using the warm air at the Lamellae through suction. Grids in the Midi section are self-supporting structures (Fig. 01 and 02). When located above the glazing, the grids can be used as maintenance and service walkways for glass cleaning. In this case, the grid elements can be folded away. If the grid is located below the glazing, heat loads occur on the grid due to absorption, which must be dissipated by ventilation.

The micro-area includes all non-self-supporting sun protection grids. These are arranged, for example, in the pane interspace (SZR) of a multiple insulating glass pane (Fig. 05). Implementing the grid in the outer SZR of a triple insulating glass pane is an advantage. The internal SZR has a positive effect on the heat transfer coefficient (U-value) and the total energy transmittance (g-value). Because the glass pane supports the grid structure, very thin and lightweight materials for the lamellae can be used. It is important to select materials, which in the long run have a perfect UV resistance and are chemically compatibility with the coatings and boundary connections of the insulated glass.

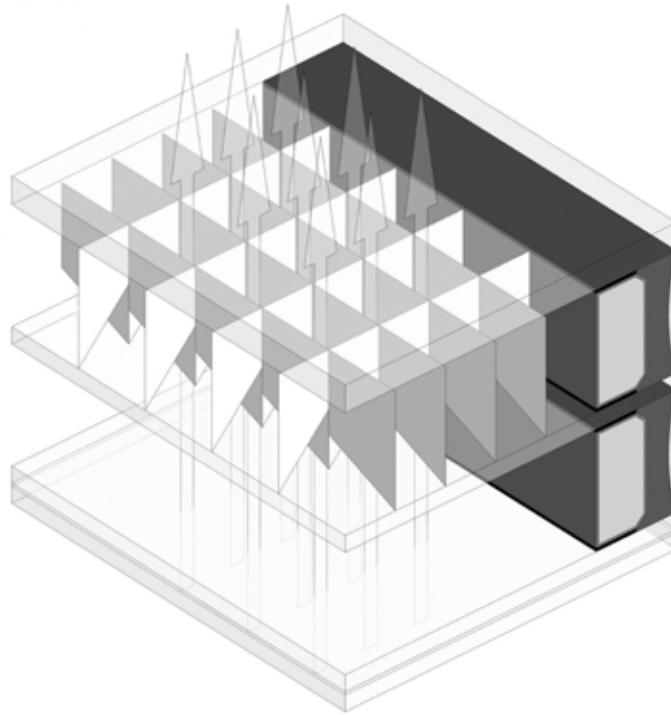

FIG. 5 Possible arrangement of a micro sun protection grid in the pane interspace of a triple insulating glass

Another way to apply the idea of the optimized sun protection grid structure is the production of nano structures. For this purpose, special manufacturing techniques are required, for example interference lithography. However, for very small structures light-diffraction effects must be considered. Applications within plastic layers in composite glasses, between two panes of glass are conceivable. These nano-structures are very subtle and not visible for the human eye (de Boer et al., 2008).

2.4 FORM FINDING FOR THE PANE INTERSPACE

For the application in the pane interspace (SZR), we need to start from a flat, non-curved grid surface. Then, each sun protection grid consists of a sequence of identical grid cells. The basic proportions of a grid cell depend on the northward orientation and tilt of the glass roof. Height of grid, latitude and the geographical location obviously must be considered. These parameters form the basis of the object-specific form finding. Other optional parameters like the light transmission and the required g_{total} value can be included in the form finding. The change of only one of the above parameters results in an altered grid structure. A glass roof in Hamburg has a different structure than in Munich and an eastward tilt of the sun protection grid has a different appearance than a northward grid. For a curved glass roof, each glass pane needs the design of its own grid structure. By individual adjustment of the grid structures, the number of lamellae is reduced to the necessary minimum. An unobstructed view is maximized accordingly and the radiation-physical properties can be defined object-related. This can be realized in real time with today's methods of computer-aided parametric design.

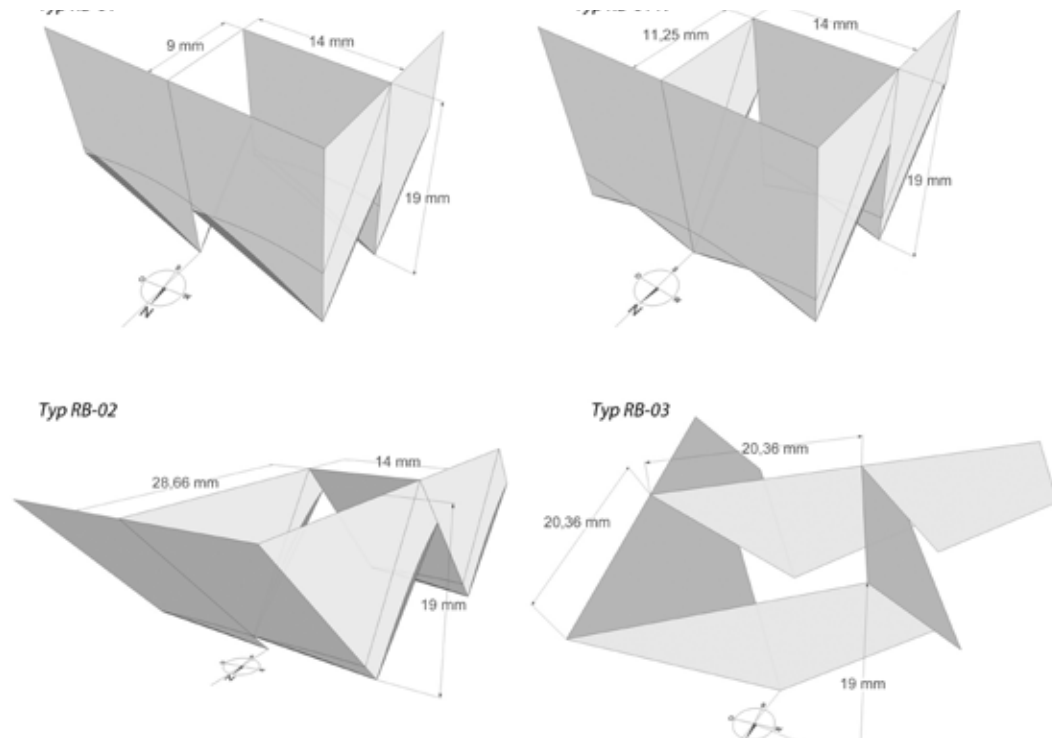

FIG. 6 Different grid geometries with the same shading performance (Kleineher, 2013)

The basic form of a sunscreen grid consists of orthogonally crossing lamellae that form a grid with flat top and bottom surfaces (Fig. 02). To improve the unobstructed sight through the grid, lamella faces which do not contribute to the shadowing can be removed. The result is, depending on the northward orientation of the roof, a sawtooth formation of longitudinal and transverse lamellae. Figure 06 shows different grid structures with a slight twist of the north axis in the installed position. The basic parameters such as the geographical location, the slope of the roof area and the northern orientation are the same for all these structures. In order to simplify the geometry the cut edges are straight. A more precise cutting of the edges without remaining areas (dark gray) is also possible. Basically, the teething can be formed facing downwards or mirrored facing upwards. This is of no consequence for the sun protection effect. For installation in the SZR, a smooth grid base is suitable. If the grid needs to be accessible, a smooth upper surface is required. Depending on the production technology, trigonal geometries or hexagonal structures can be applied.

Using parametric 3-D drawing programs, for example, Rhino with Grasshopper plugin, appropriate programming of the various structural geometries can be easily generated and changed in a very short time, as well as be assessed and adapted to any structural-physical requirements. Implemented sun lanes and parameters mentioned above are the foundation for the utility patent protected (Kleineher, 2014) form finding. Other design parameters are the inclination or rotation of individual lamellae, the total number of lamellae or the maximum degree of shading. CAM interfaces with manufacturing techniques can be shown. Thus, a loss and error-free transmission of data from design to computer-aided manufacturing is possible.

The lower the height of the grid, the more fins and joining points are needed. Therefore, as already mentioned, one focus in the development of the sun protection grid is the reduction of the number of segments. If the lengthwise lamellae are aligned northward (Type RB-01 N), the number of transverse lamellae is reduced. If the transverse lamellae (Type RB-02) are tilted in addition, the number of lamellae can be reduced even further. Tilting both, lengthwise and transverse Lamellae (Type RB-03), the smallest number of lamellae are needed, about 50% less compared to type RB-01 (Fig. 06). Tilting

the Lamellae has as a consequence the reduction of an unobstructed view to the outside and the reduction in light transmission. However, the sun protection effect (g_{total} value) increases. The classic conflict of goals in the field of sun protection is apparent: Less light corresponds to a higher sun protection. Therefore, depending on the individual requirements of the sun protection, the application and the manufacturing technology, the optimal structure for the application must be ascertained. For this purpose this system offers many possibilities and creative freedom.

2.5 PRODUCTION FOR THE PANE INTERSPACE

For dimensions and proportions of a sunscreen grid in the glass clearance (SZR) the glass composition or the thickness of the SZR is significant. It defines a parameter. For experimental tests, prototypes for SZR at 20 mm thickness, e.g., are produced. Since the grid doesn't need to withstand greater stresses, a thin Cardboard can be used for lamella material. The carton is lignin free and very UV stable. The current production approach allows for an addition of single transverse and longitudinal lamellae via plug connections. From the grid geometries generated in a 3-D-program, 2 D sectional vectors for the lamellae are produced, which can be used a CO_2 -laser to cut the individual lamellae out of cardboard sheets. Guiding racks and other tools facilitate connecting the grid. The finished sun protection grid is integrated into the pane interspace at the insulating glass manufacturer's plant where the insulating glass unit is completed. Optionally, the SZR of the grid is filled with inert gas.

Since March 2014, nine pieces of triple insulated glasses (a total of about 13 m^2) with three different grid structures, made of cardboard, in SZR are successfully tested (Fig. 03). The glass composition is :12 | 27 # | 6: | 16 | 13.5, the grid therefore is in the outer SZR and 27 mm high. The g_{total} value is depending on the grid structure approximately from 0.10 to 0.12. A second low-E coating in the outer SZR was initially omitted ($U_g = 0.9$), because it is an unheated workshop.

2.6 SOLAR CHARACTERISTICS

For experimental tests, several prototypes are created. To be comparable, all prototypes fulfill the identical basic parameters (location, installation position, height of the grid) and offer year-round full shading. They only differ in the materials and the number and orientation of the Lamellae. For the experimental measurements of transmission and reflection of the different grid geometries (Fig. 8) on an integrating sphere seven test bodies with various materials, structures and geometries are produced. In each test body, 38 measurements for reflection and transmission are made from different beam directions that simulate the path of the sun over the entire year. A total of around 800 measurement data are obtained, permitting precise analysis of the different grid geometries. As shown in Table 02, the four grid structures showing highly differentiated characteristics. The differences between RB-01 and RB-01N, with north-facing lengthwise lamellae, are still relatively low. The tilt of the lamellae in RB-02 and RB-03 leads to a reduction in the transmission, while simultaneously increasing the reflectance. Figure 07 illustrates the different characters of the grid structures. The results of measurements of reflection, transmission and absorption are each shown in a diagram. The structures RB-01 and RB-01N have relatively flat, uniform graphs. Transmission and reflection are relatively evenly over the day. The structures RB-02 and RB-03 have, in contrast, strongly sloping transmission values on to the high sun. This can be explained by the stronger reflection of the tilted Lamellae.

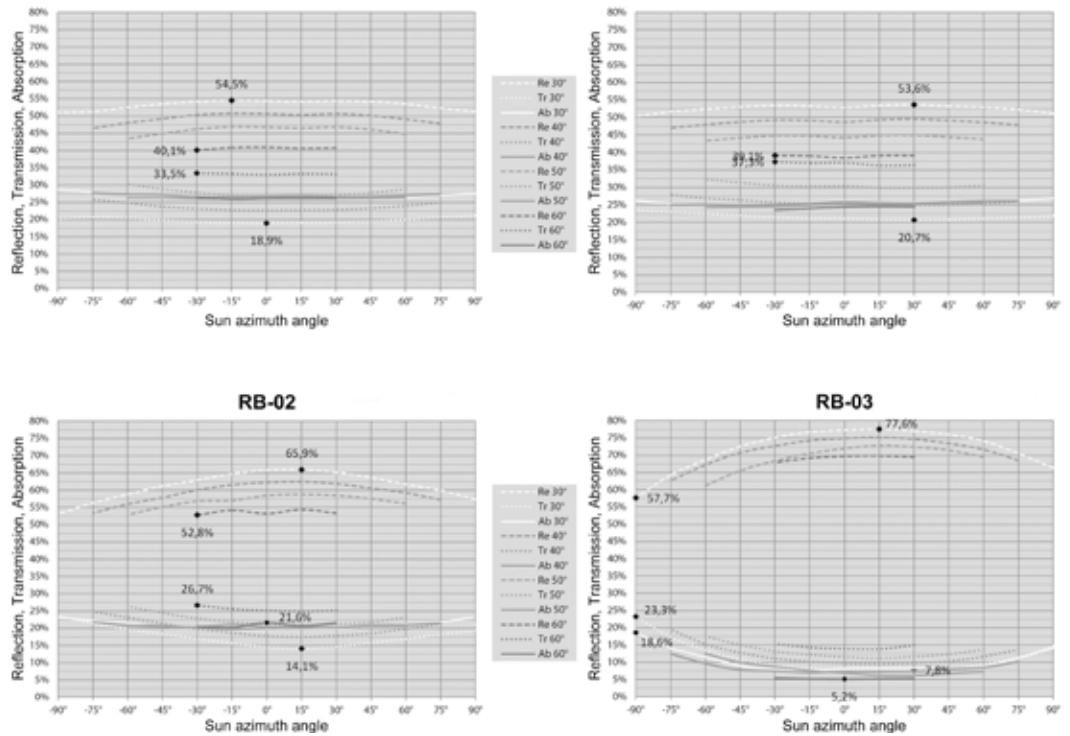

FIG. 7 Solar characteristics to type of grid and position of the sun (Kleineher, 2013)

On two prototypes with triple glazing, dimensions approximately 1000 x 1000 mm, gtotal values are measured in a test stand with liquid calorimeter at ift Rosenheim. The measured values serve as reference values for later calculations. The audited gtotal value for a sun elevation angle of 40 ° and an azimuth angle of 10 ° is 0,19. This doesn't seem impressive at first sight. However, the triple glazing of the test body only has a low-E coating at position 5 to test the sun protection effect of the grids in the pane interspace without major distortions through the glass assembly. Therefore, the Ug value of the glazing is only 0.9 W/(m²K), the g-value 0,56. Recalculations of the measured values gtotal according to DIN EN 13363-1, including the measurements of the integrating sphere get results with only very small deviations, allowing for more gtotal value calculations; this method according to DIN can be considered to be sufficiently accurate. The final calculations show that with improved glass values the g values turn also positive. The results for four exemplary structures (Fig. 07) are summarized in Table 01. In a calculation with spatially averaged transmission factors of an outdoor-test, better results are expected. In Table 02, the traditional conflict in sun protection is clearly visible again: the better the solar shading (g-value), the smaller the light output or transmission.

G _{TOTAL} VALUE ACCORDING TO DIN EN 13363-1	TYPE RB-01	TYPE RB-01 N	TYPE RB-02	TYPE RB-03
Glazing 01: U = 0,9 W/m²K; g = 0,56	0,19	0,20	0,16	0,12
Glazing 02: U = 0,5 W/m²K; g = 0,40	0,12	0,13	0,10	0,07

TABLE 1 Calculation of gtotal values according to DIN EN 13363-1 for different structures at 40 ° sun elevation angle and 10 ° azimuth angle

MEASUREMENT ACCORDING TO DIN 5036	TYPE RB-01	TYPE RB-01N	TYPE RB-02	TYPE RB-03
Reflexion	0,50	0,49	0,63	0,75
Transmission	0,23	0,25	0,18	0,10
Absorption	0,27	0,26	0,19	0,15

TABLE 2 Measurement of reflection, transmission and absorption for different structures at 40 ° sun elevation angle and 15 ° azimuth angle

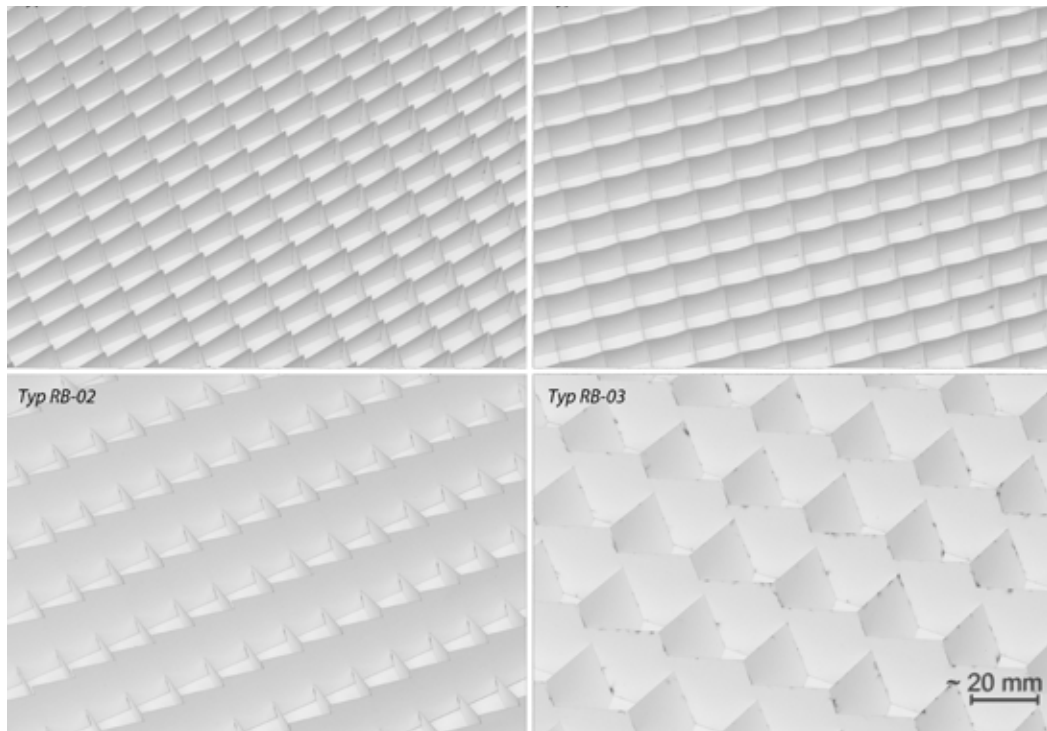

FIG. 8 Different grid geometries for the experimental measurements on the integrating sphere (Kleineher, 2013)

3 CONCLUSIONS AND OUTLOOK

The experimental measurements and subsequent calculations confirm the subjective impression of the high efficiency of this fixed sun protection system. Opposite movable, mechanically driven systems, it has significant advantages. The terms maintenance-free, wind stability and largely unobstructed view with a high sun protection with a g-value of up to 0,07 speak for themselves. Next to the thermal criteria, the visual properties, such as the homogeneous light distribution and nonexistent glare, are remarkable. The Cardboard used for the lamellae without further coatings also reflects a very neutral light spectrum and is easily separable and recyclable.

In the development, aluminum has been studied as a possible lamella material. Due to the comparatively expensive basic price and the very high energy requirements for CO₂-lasers as well the high light absorption of the material, its use in the micro-area will not be pursued.

At present, the presented system is successfully installed on two objects: since May 2009, it is used as an accessible grid in midi-area above a Skylight (Figure 01 and 02). Since March 2014, the long-term stability is observed in nine skylights on different micro-grid structures in the pane interspace (Fig. 02).

Further development in the micro-area allows for a production in 3-D printing. Currently, the addition of Cardboard Lamellae is complex and will be omitted and replaced by direct printing of the grid structure. New, non-linear structures can be printed. Also, different cell sizes and subdivisions within a grid are possible. More design options, as in a targeted light-shadow-play or graphical structures, are therefore realizable. Eco-friendly, low-cost materials already exist in the Fused Deposition Modeling technique (FDM) and the printing technique is sufficiently precise and filigree. Large-scale production for insulated glasses, the thermally induced distortions during cooling and the relatively

long printing times currently present problems still. Through the rapid development in 3-D printing, these problems will be a thing of the past in the near future. It is intended to create a prototype of a micro-grid structure in FDM-printing technique and to determine the solar characteristics as well to test the long-term behavior.

The presented system is trademark protected (Kleineher, 2013) and patent pending (Kleineher, 2014) in Germany. The author seeks to develop the solar shading system further to market.

References

- Kleineher, D. (2013). Feststehendes Sonnenschutzsystem für Überkopfverglasungen. unveröffentlichte Master-Thesis, Hochschule Rosenheim
- de Boer, J. et al. (2008) Sonnenschutz. Schutz vor Überwärmung und Blendung. Stuttgart: Fraunhofer IRB Verlag
- Kleineher, D. (2013). Sonnenschutzvorrichtung mit einer Lamellenstruktur. Deutsches Patent- und Markenamt. Gebrauchsmuster-Nr.: 20 2013 101 586.5. Anmeldedatum 15.04.2013
- Kleineher, D. (2014). Sonnenschutzvorrichtung mit einer Lamellenstruktur. Deutsches Patent- und Markenamt. Patentanmeldung-Nr.: DE 10 2014 105 304 Anmeldedatum 14.04.2014
- DIN 5036-3 (1979). Strahlungsphysikalische und lichttechnische Eigenschaften von Materialien – Messverfahren für lichttechnische und spektrale strahlungsphysikalische Kennzahlen
- DIN EN 13363-1 (2003). Sonnenschutzvorrichtungen in Kombination mit Verglasungen – Berechnung der Solarstrahlung und des Lichttransmissionsgrades – Teil 1: Vereinfachtes Verfahren
- VDI 6011, Blatt 1 (2002). Optimierung von Tageslichtnutzung und künstlicher Beleuchtung - Grundlagen. Düsseldorf
- VDI 6011, Blatt 2 (2006). Optimierung von Tageslichtnutzung und künstlicher Beleuchtung - Dachoberlichter. Düsseldorf
- Pistohl, W. (1998). Handbuch der Gebäudetechnik. Heizung/Lüftung/Energiesparen. Düsseldorf: Werner Verlag
- Köster, H. (2004). Tageslichtdynamische Architektur. Grundlagen, Systeme, Projekte. Basel: Birkhäuser
- Eisele, J.; Staniek, B. (Hrsg.). (2005). Bürobau Atlas. München: Callway
- Brandi, U. et al. (2005). Tageslicht, Kunstlicht. Grundlagen, Ausführung, Beispiele. München: Institut für internationale Architektur-Dokumentation GmbH & Co. KG
- Petzet, M.; Heilmeyer, F. (2012): Reduce, Reuse, Recycle. Ressource Architektur. Ostfildern
- Herzog, T.; Krüppner, R.; Lang, W. (2016). Fassaden Atlas. München: Institut für internationale Architektur-Dokumentation GmbH & Co. KG

Subdivided switchable sun protection glazing*

Marzena Husser¹, Walter Haase¹, Werner Sobek^{1/2}

¹ Institute for Lightweight Structures and Conceptual Design (ILEK), University of Stuttgart, Germany

² Werner Sobek Group GmbH, Germany

Abstract

The façade, as an interface between the interior and the exterior environment, performs multiple tasks. It has to ensure the highest possible comfort for building occupants on one hand, on the other hand it should contribute to minimizing the energy demand of the building. In detail, the requirements on a façade depend on its orientation, climatic conditions and the building use. Since the surrounding conditions vary, an invariant system cannot react to this variability to the full extent. In order to overcome this limitation, the authors are developing a switchable glazing unit with adjustable light and energy transmission properties. Its functionality is based on the use of liquid crystal materials. The main component of the switchable glazing is a thin switchable cell which is embedded in an insulating glazing unit. Like in liquid crystal displays, it is possible to subdivide the glazing area in small, individually switchable pixels. The transparency of each pixel can be controlled independently, so that an effective daylight and shading control can be provided within one glazing unit. This subdivision opens new possibilities of functional integration within glass façades and paves the way for new architectural qualities. Currently, a prototype glazing is investigated under outdoor conditions. Prototypic cells are arranged in nine rows in order to cover a floor-to-ceiling glazing. Though, other dimensions of insulating glazing units are possible as well. In order to enhance the effectiveness of the system, the authors are developing different control strategies. The switchable glazing system and its simulation-based performance analysis will be presented within the paper.

Keywords

Switchable glazing, adaptive glazing, liquid crystals, control strategies, building simulation

* Full paper published in GS&E / Glass structures & Engineering, 2017.

FAÇADE ENGINEERING

A zero-energy refurbishment solution for residential apartment buildings by applying an integrated, prefabricated façade module

Thaleia Konstantinou¹, Olivia Guerra-Santin², Juan Azcarate-Aguerre¹, Tillmann Klein¹, Sacha Silvester²

- 1 Department of Architectural Engineering and Technology / Faculty of Architecture and the Built Environment / Delft University of Technology, Julianalaan 134, 2628 BL, Delft, the Netherlands, Email: t.konstantinou@tudelft.nl*, J.F.AzcarateAguerre@tudelft.nl, t.klein@tudelft.nl
- 2 Department of Industrial Design / Faculty of Industrial Design Engineering / Delft University of Technology, Landbergstraat 15, 2628 CE Delft, the Netherlands, Email: O.GuerraSantin@tudelft.nl, S.Silvester@tudelft.nl

Abstract

The ambition to renovate the post-war building stock to an energy-neutral quality is getting a lot of attention in social housing association and other institutional owners, financial institutions and users. The Energy Agreement for Sustainable Growth indicates that 300.000 dwellings have to be renovated in the Netherlands annually. An effective renovation plan has to be long-term, target the deep transformation of the existing building stock, and to significantly improve its actual energy performance towards nearly zero energy levels. This level of energy saving typically requires a holistic approach, viewing the renovation as a package of measures working together.

Even though the need for refurbishment is urgent, the rate of renovation and the resulting energy savings are relatively low. Main barriers identified are related to the available investment funds, awareness, advice and skills and the separation of expenditure and benefit.

To address these issues, the paper presents a prefabricated and integrated façade module that gives the possibility to improve the current energy performance up to zero energy, while ensuring minimum disturbance for the occupants, during and after the renovation. Given that the design and installation take this constrain into consideration, it is possible to reach zero energy by adding more efficient installations and energy generation, as well as taking possible behavioural changes into account. Moreover, the paper evaluates such a zero-energy refurbishment in terms of financial feasibility. The proposed approach results in a feasible solution, which achieves high energy savings and addresses the complex issue of integrated refurbishment.

Keywords

refurbishment, residential building, zero-energy, prefabrication, façade module

1 INTRODUCTION

The ambition to renovate the post-war building stock to an energy-neutral quality is getting a lot of attention of social housing corporations and other institutional owners, financial institutions and users. Studies have reported huge potential for energy savings, improved health and comfort of the occupants, elimination of fuel poverty and job creation lay in the upgrade of existing buildings. The Energy Agreement for Sustainable Growth (SER, 2013) (in accordance with the Energy Performance of Buildings Directive adopted by the European Union (DIRECTIVE, 2010/31/EU) to improve the Dutch building stock to energy neutral) indicates that 300.000 dwellings have to be renovated in the Netherlands annually.

The post-war building stock, which represents 33% of residential buildings (CBS, 2015), is particularly relevant for refurbishment. Despite its varied mix of construction types, from traditional to modern, from low rise to high-rise, it has as a common characteristic that the buildings were generally poorly insulated at the time of construction and that there is a need for renovation (Itard & Meijer, 2008). Due to the circumstances of its development, the post-war housing stock has specific characteristics in terms of neighbourhood design, construction and problems. Moreover, being 50 years old, the building envelope has reached end of life while structure is in general sound (Andeweg et al., 2007). A number of façade solutions have been developed in recent years to solve the problem of large-scale renovation of housing (Sijpheer et al., 2016). In the Netherlands, front-running housing associations have the ambition to achieve an energy-neutral renovation approach, and so, some façade solutions aim at energy neutrality, such as the Stroomversnelling (2013). However, few address the complexity of multi-family rental dwellings and more importantly, the complexity of user behaviour in the actual performance of the buildings. To reach the ambition of the Dutch government for energy savings, it is necessary to develop products and processes for renovating the multi-family apartment blocks within the existing housing stock. Previous experiences showed that there is still an enormous challenge to fulfil the ambition to make the porch apartment energy neutral for an affordable price and in an acceptable way for the residents (Silvester, 1996; Winter, 1993).

In this context, the "2ndSkin" project brings together different stakeholders of the building industry, aiming at integrating their expertise and objectives into an innovative building retrofitting concept that achieves zero energy use of a dwelling, while offering up-scaling possibilities. The hypothesis of the project is that zero-energy refurbishment can be promoted and its rate can increase if the application of prefabricated façade modules, which increase the installation speed and minimise disturbance for the occupants. Moreover, the objective is not only to find a successful refurbishment strategy for a specific building type, but also to determine the framework within which the proposed solution can be adjusted. The focus of the 2ndSkin project is the low-rise, multi-family residential buildings, accessed by separate stairwells per 6-8 apartments. This type of building represents about 300.000 houses. Nevertheless, the concept of the renovation can be applicable in apartment blocks of other than the post-war period, increasing significantly the impact of the solution with a potential target of 875.000 apartment blocks in the Netherlands (Voorbeeldwoningen, 2011).

To address these issues, the paper presents a prefabricated and integrated façade module that gives the possibility to improve the current energy performance up to zero energy, while ensuring minimum disturbance for the occupants, during and after the renovation. Given that the design and installation take this constrain into consideration, it is possible to reach zero energy by adding more efficient installations and energy generation, as well as taking possible behavioural changes into account. The technical upgrade of the proposed refurbishment solution is explained. Moreover, energy calculations to determine the energy generated needed to reach zero-energy are presented. Finally, the paper evaluates such a zero-energy refurbishment in terms of financial feasibility.

2 THE 2NDSKIN REFURBISHMENT CONCEPT

The design of the renovation solution focuses on a reference building that has been identified as a type which, given the poor thermal quality of the construction and the number of units in the Netherlands, offers the best market and carbon emission reduction opportunities. To define the reference building, literature research and an on-site investigation was carried out in the area of Rotterdam-Zuid. Systematic documentation of the building characteristics was conducted during on-site visits. A reference building type was determined, which is considered the most common type in the area of investigation while having typical characteristics found in the building stock analysis. The reference building, as shown in fig.1, is a mid-rise apartment block with central staircase, accessible in the front façade, leading to two apartments per floor. Its construction characteristics are massive concrete wall and brick cladding with an intervening, non-insulated cavity, reinforced concrete slabs, continuous to the balconies, and large windows, incorporating lightweight parapet.

The 2ndSkin design principle to reach zero-energy dwellings is based on preventing the use of energy, then use sustainable energy sources as widely as possible (renewable) and, finally, if the use of finite (fossil) energy sources is inevitable, they must be used efficiently and compensated with 100% renewable energy (AgentschapNL, 2013). The concept needs to combine the building envelope upgrade, the use of efficient building systems and the generation of energy. Moreover, both physical condition and performance of the building need to be upgraded with the minimum disturbance to the interior, so that the occupants do not have to be relocated during the construction. As part of the approach, requirement for the performance, such as building envelope thermal conductivity, ventilation rates etc., as well as standards for the occupant role, position and disturbance during and after renovation were developed (Konstantinou et al., 2015).

To meet the requirement of zero-energy consumption, the solution consists of three basic elements: Increase the thermal resistance of the building envelope, including walls, windows and roof, installing heat recovery ventilation, to reduce energy demand for heating while providing adequate indoor air quality (IAQ), and use photovoltaic (PV) panels to generate energy. The proposed renovation solution results in the required thermal characteristics of the envelope, in terms of thermal resistance and infiltration, as well as providing an updated the building services' performance, as summarised in Table 1. These benchmark values were also used in the energy simulation, explained in evaluation section of the paper.



FIG. 1 The reference building

ELEMENT	SPECIFICATIONS
Roof	Rc 4.5
Facade elements	Rc 6.5
Ground floor	Rc 3.5
Window frames	Rc 0.8
Double glazing	U 0.8 (1.135) g _g 0.8
Infiltration	0.4 dm ³ /s.m2
Ventilation system	Balanced ventilation efficiency 0.75

TABLE 1 Input for building simulation software after renovation of building

Next to minimising the energy use, the renovation needs to address the issues of occupants' position during and after renovation. The 2ndSkin refurbishment approach aims at eliminating the energy demand, while minimising construction time and occupants' disturbance and the owner needs to acquire the acceptance of at least 70% tenants, which is needed legally in the Netherlands for the renovation to proceed. To this end, the suggested construction process differs from conventional renovation process in the fact that the technology is seen as independent from the underlying structure of the building, and integrated into the facade. The system integrates heating and ventilation into the skin (fig. 2) so it can be easily accessible from the outside of the building, therefore facilitating the maintenance. Heat recovery ventilation units are placed on the rooftop, while the ventilation pipes are integrated in an insulation board, attached to the sandwich panel that covers the opaque part of the existing façade. Regarding heating, the concept includes an all-electric decentral heat pump system for heating and DHW, with a 200litre buffer tank, per apartment. One of the possible locations in the façade of the staircase. The flexibility of the system and the accessibility from the outside the dwellings allows maintenance and upgrading the installations in further phases of the development during the lifetime of the building, thus increasing the time-span of the initial investment.

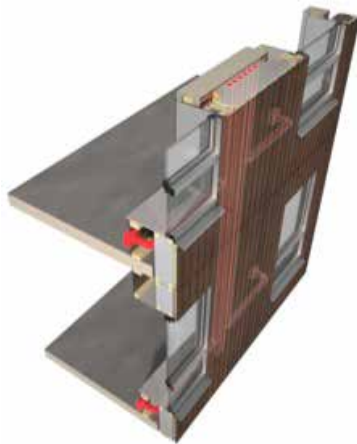

FIG. 2 Detailed 3d section, showing the ventilation pipes integration.

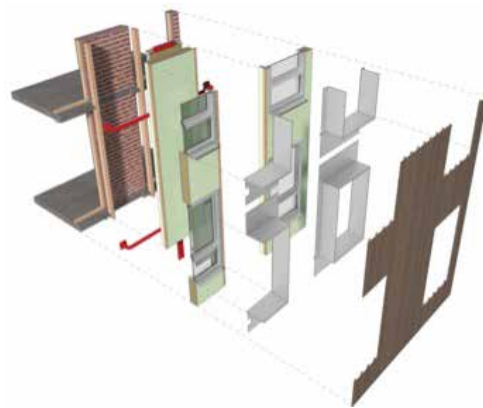

FIG. 3 The sequence of the prefabricated elements installation (from the left to the right).





SCENARIO	ORIENTATION	TYPE OF ROOF	PRODUCTION IN ROOF (KWH/YEAR/APARTMENT)		TOTAL ENERGY PRODUCTION INCLUDING FACADES / APARTMENT	
			PORCH 6 UNITS	PORCH 8 UNITS	PORCH 6 UNITS	PORCH 8 UNITS
EW_flat	East-West		1738.4	1303.8	2553.37	1915.03
NS_flat	North-South		1299.2	974.4	1739.87	1110.41
NS_flat_b	North-South		3257.4	2443.1	3698.07	2579.11
EW_pitch	East-West		1738.4	1303.8	2553.37	1915.03
NS_pitch	North-South		869.2	651.9	1309.87	787.91

TABLE 2 Total energy production per apartment in kWh/year per building/roof scenario

To achieve minimum disturbance, a starting point of the design was for the facade module to be prefabricated. During the renovation process, firstly the building envelope is insulated with prefabricated sandwich panels. Moreover, existing windows are replaced. The prefabricated, floor-height, sandwich panels, featuring new windows and integrated services pipes, are attached to the substructure that consists of wooden posts connected to external facet of the existing structures through steel U profiles. PV panels are installed on the roof, while installations to improve ventilation are also integrated in the rooftop. The ventilation pipes are integrated in an insulation board, attached to the sandwich panel that covers the opaque part of the existing façade. This panel is installed first and it comes to the building site as one piece, in order to minimise the connections between the pipes. The panels containing the windows are connected to the wooden posts subsequently.

Finally, photovoltaic panels are also integrated in the skin in order to reach the zero energy targets. Energy generation was calculated for five scenarios, taking into account the orientation of the building, the type of roof, and the possibility to provide an attic for installations. The five scenarios are: North-South orientation with flat roof, North-South orientation with pitched roof, North-West orientation with flat roof with an attic for installations, East-West orientation with flat roof, and East-West orientation with pitched roof.

Calculations were made assuming the use of a CSun255-60P solar panel (CSUN, 2014). Results of the calculations are shown in Table 2. The energy generated in the roof of the building is divided by the number of apartments in the buildings. Such building types are usually either three or four-floor high. Given that the 2ndSkin strategy could be applied to both possibilities, we studied the results of the calculations considering both scenarios. The energy generated per apartment can be seen in the right-side columns of Table 2. The total energy production takes into account the potential of energy generation using the opaque parts of the façade.

3 EVALUATION OF ENERGY PERFORMANCE AND FINANCIAL FEASIBILITY

After the refurbishment concept was developed, it needed to be evaluated. The evaluation is based, firstly, on simulating the reduced energy performance, after the renovation and defines the scenario in which this demand can be compensated with the energy generation. Furthermore, the payback time of the initial investment is calculated.

3.1 ENERGY PERFORMANCE

In this section, the energy calculations are presented. The simulation takes into account both building-related (heating, ventilation, lighting) and user-related (domestic hot water, appliances) energy consumption, as it was defined in the requirements (Konstantinou et al., 2015). The building related energy is mostly The dynamic building simulations were carried out with Bink software (BINKSoftware, 2015). Each room is modelled as one thermal zone, as we wish to investigate the effect of the room temperatures and spaces heated have on energy demand. Natural ventilation is only considered for the summer period, when external temperature reaches 18°C or internal temperature exceeds 25oC. Thus, natural ventilation does not have an effect on heating demand in the simulations.

For inputs regarding heating demand, two behavioural scenarios were used. In the first scenario, the occupants continue their pre-renovation state-of-the-art behaviour, based on the statistical analysis of the WoON dataset (WoON2012, 2013), reflecting the lifestyle and preferences of Dutch households. In the second post-renovation scenario, we assumed an adapted behaviour, based on a better control on the heating system, by heating only occupied spaces and using a setback in the thermostat during unoccupied hours and night-time.

The internal heat gains are integrated into the simulation model in two ways. Artificial lighting is defined as specific artificial use patterns. Internal heat gains for appliances and electric equipment are calculated based on statistical data on electricity consumption per household type in reference dwellings (WoON dataset).

A second set of simulations were carried out assuming a change on behaviour after the renovation. In this scenario, we consider behavioural changes to the current situation, namely increasing the indoor temperature, and assuming a better control on the heating system, by heating only occupied spaces and using a setback in the thermostat during the night and during absent hours.

The energy demand for domestic hot water was calculated, assuming five minutes showers per person per day, one and a half minutes using the sink per person per day, and using the kitchen sink for one minute per household per day. In addition, a scenario considering the use of a heat recovery shower was also calculated. According to specifications, these systems can save up to 100 m³ gas /year per household (ISO7730, 2005) or 30% of the energy use. In order to take into account the household size, we use the value of 30% reduction.

Fig. 4 shows a comparison between the energy (gas and electricity) consumed in the reference dwellings (based on WoON statistical (WoON2012, 2013)), and calculated energy demand (for heating, domestic hot water and electricity) based on the two scenarios for behaviour and electric appliances explained above:

- Scenario 1: inefficient appliances and unchanged behaviour, and
- Scenario 2: efficient appliances and adapted behaviour.

Inefficient appliances and behaviours is based on the electricity demand calculated using the energy consumption of inefficient appliances, and the pre-renovation behaviour and they are average for different household types (Guerra-Santin et al., 2016). Efficient appliances and behaviours scenario is based on the electricity demand calculated using the energy consumption of efficient appliances, and the post-renovation behaviour. The figure shows that the energy demand of the 2ndSkin technical solution (i.e. only renovation without behavioural change or change for more efficient appliances) is reduced by 66%. If we also consider a scenario with improved appliances and behaviours, we reach a reduction on energy demand of 78%. If considering the heating demand alone, which accounts for the largest percentage of energy consumption in the building stock (BPIE, 2011), it is minimised, with a reduction of 93% after the refurbishment solution.

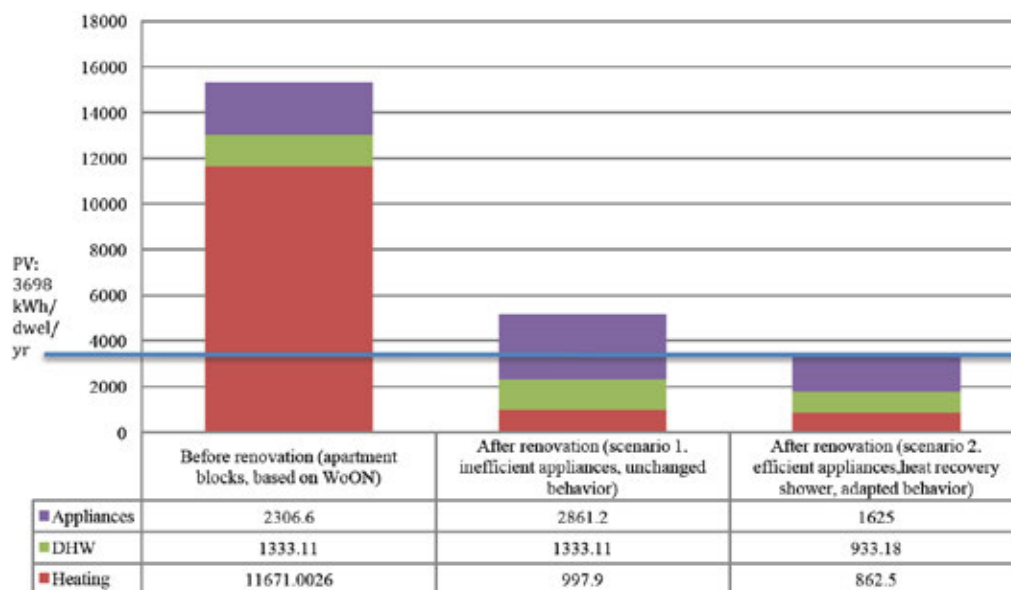

FIG. 4 Energy demand in kWh/dwelling/ year, calculated based on inefficient and efficient appliances and behaviours in comparison to the statistical energy consumption in reference dwellings. This explains the difference in the energy use for appliances between statistical and assumed appliances use. The blue line indicates the maximum electricity production in kWh/dwelling/year.

3.2 ZERO-ENERGY POTENTIAL

The comparison of shows that only in the best case scenario for energy generation using PV panels on the roof (Table 2), which is a porch building with 6 apartments, and with the possibility to build an attic structure to support the PV panels, the energy generated barely covers the energy demand when domestic hot water and electricity are considered, considering the energy efficient scenario. Considering the inefficient scenario, the best-case energy generated covers half of the demand. For an east-west orientation, the total energy demand can be almost met with the energy production on-site for buildings with three levels (six housing units). To cover the energy demand of north-south orientations without attic provision, and apartment buildings with four levels, an extra surface of 12-20m² of panels is needed. Moreover, in all other roof scenarios, the energy generated only covers the heating demand in all cases, except in four-storey buildings with North-South orientation and pitched roof.

3.3 FINANCIAL ASSESSMENT

For the financial assessment of the solution, first the initial investment was calculated. The costs included the façade module production and construction, roof insulation, building services units and PV panels, as well as preoperational works on the building site, such as removal of the components to be replaced and new foundations for the façade module. The façade module and its installation accounted approximately for 40% of the initial investment.

In order to determine the financial payback time of a full 2ndskin renovation, a comparison has been made between the benchmark energetic consumption of a typical case-study dwelling, and the simulated consumption of the unit after renovation. According to previous studies (Guerra Santin et al., 2015), the current energy use of a model dwelling under average occupancy is approximately 1.200m³ of gas (or nearly 12.000 kWh of thermal energy) and 2.300kWh of electric energy. Using energy price values for the Netherlands in 2015, according to data from the European Committee (Eurostat, 2016), this adds up to estimated yearly costs of 1.340 euros. Considering energy prices in the last two decades have been subject to an upward trend which averages 4.5% per year (CBS, 2012) the total cost of energy per dwelling in the coming 25 years could add up to nearly €60.000.

A simple payback analysis, balancing only the initial investment required for the renovation against the potential energy savings resulting from it, shows that a complete 2ndSkin renovation would have a payback time of just over 25 years, or a simple average rate of return of 4% per year. This takes into account the best scenario, for the energy production through PV, when zero-energy consumption is achieved. Partial renovations, which include only certain steps in the 2ndSkin renovation strategy, are shown to be unfeasible in their current form, as their payback time exceeds the 40 year period. While the current low cost of energy renders short-term returns unattractive, the performance of the investment is most likely to experience significant gains over time due to the high compound increase in energy prices. The 4% RoI value for a complete renovation is also most likely to improve if we consider additional financial parameters such as the resulting increase in the rent price and market value of the property, resilience against fluctuations in energy costs, and access to green subsidies or other forms of low-cost financing, even after taking into account negative factors such as general inflation rate and the client's cost of capital.

4 CONCLUSION

Within the framework of the research project 2ndSkin, which aims at the development of a refurbishment approach for zero energy renovation of apartments, the paper discussed the technical solution, the construction process and evaluated the energy performance after renovation and the financial aspects. The project's main requirements are zero-energy demand and minimum disturbance for the occupants during the renovation. The proposed solution consists of prefabricated modules, in order to reduce the construction time, that integrate high insulation for wall and windows, together with ventilation pipes. In this way, both the envelope and the building services are upgraded. Furthermore, energy generation is necessary to reach the zero-energy target, energy is generated with PV cells on the roof and potentially the façade.

Taking into account the resulting energy demand after renovation (Fig. 4) and the possibilities for energy generation, using PV panels on the roof (Table 2), we conclude that the zero-energy target can indeed be met, under specific conditions. The results show that the total energy demand can only be covered by energy production with the provision of an attic (north-south orientation) on up to three levels porch buildings. Therefore, extra surface of photovoltaic panels would be necessary to achieve the zero-on-the-meter solution only with photovoltaic panels. Façade surfaces could potentially be used to cover the rest of the energy generation required, depending on the orientation of the building. Nevertheless, the building-related energy consumption for heating can be easily covered, as proposed solution significantly reduced the demand.

The overall solution can, hence, be an answer to the need for upgrade the building stock to provide comfort and low energy demand, with minimum occupants disturbance. The construction system is based on prefabrication, maintaining still some degree of flexibility, such as different type and size of windows or different cladding material. In this way, the concept aims at higher acceptability and, thus, applicability.

Further research will include the specific design and prototyping for different buildings. Moreover, the design adaptations can be extrapolated for buildings in a European level that have similarities in the key characteristics determined by the study, providing an answer to the necessary energy upgrade of the European building stock. The proven applicability of the concept for different building types is important, because the uptake of the zero-energy refurbishment determines the CO₂ mitigation and the potential of reaching the decarbonisation targets.

Most importantly, the market intake of such renovation is currently very slow, as housing associations are reluctant to invest the increased cost of a zero-energy refurbishment, despite the energy savings and the benefits for the occupants. A more complete financial breakdown of this case-study concept, as well as options to lower the initial investment, such as subsidies or alternative business models, need to be further elaborated, in order to provide insights for a more attractive business case.

Acknowledgements

The project presented in the current paper is co-funded by Topconsortia voor Kennis en Innovatie (TKI) and Climate KIC-EIT Flagship BTA/Innovative Facades. The authors would like to thank all the members of the consortium (BAM, ENECO, Hogeschool Rotterdam, Spee Architects) for their contributions to the project development.

References

- AgentschapNL. (2013). Infoblad Trias Energetica en energieneutraal bouwen. In A. M. v. E. Zaken (Ed.). Utrecht.
- Andeweg, M. T., Brunoro, S., & Verhoef, L. G. W. (2007). Cost C16- Improving the quality of existing urban building envelopes: State of the art: IOS Press.
- BINKSoftware. (2015). BINK Energie-advies suite. Retrieved from <http://www.binksoftware.nl/>
- BPIE. (2011). Europe's buildings under the microscope. Brussels: Building Performance institute Europe.
- CBS. (2012). Energie 9 procent duurder. Retrieved 19-09, 2016, from <https://www.cbs.nl/nl-nl/nieuws/2012/10/energie-9-procent-duurder>
- CBS. (2015). Centraal Bureau voor de Statistiek : Voorraad woningen; woningtype, bouwjaar, oppervlakte, regio. Retrieved 12/10, 2015, from <http://statline.cbs.nl/StatWeb/publication/?VW=T&DM=SLNL&PA=82550NED&LA=NL>
- CSUN. (2014). CSUN255-60P:Standard solar product. Retrieved June, 2016, from <http://www.csun-solar.com/index.html>
- DIRECTIVE. (2010/31/EU). on the energy performance of building. Brussels: THE EUROPEAN PARLIAMENT AND OF THE COUNCIL.
- Eurostat. (2016). "Electricity and gas prices, second half of year, 2013-15" - Statistics Explained Retrieved 19/09, 2016, from [http://ec.europa.eu/eurostat/statistics-explained/index.php/File:Electricity_and_gas_prices,_second_half_of_year,_2013%E2%80%9315_\(EUR_per_kWh\)_YB16.png](http://ec.europa.eu/eurostat/statistics-explained/index.php/File:Electricity_and_gas_prices,_second_half_of_year,_2013%E2%80%9315_(EUR_per_kWh)_YB16.png)
- Guerra Santin, O., Silvester, S., & Konstantinou, T. (2015). 2nd Skin approach to zero energy rental properties: Occupancy patterns to improve energy simulation. Paper presented at the PLEA 2015: 31th International PLEA Conference "Architecture in (R) evolution", Bologna, Italy, 9-11 September 2015. <http://repository.tudelft.nl/view/ir/uuid%3A5b0a88%da3e-4aac-b2eb-56f30d8e50b8/>

- Guerra-Santin, O., Bosch, H., Budde, P., Konstantinou, T., Boess, S., Klein, T., & Silvester, S. (2016). 2ndSkin approach to zero energy renovation. Paper presented at the BEHAVE 2016, Coimbra, Portugal.
- ISO7730. (2005). Ergonomics of the thermal environment - Analytical determination and interpretation of thermal comfort using calculation of the PMV and PPD indices and local thermal comfort criteria (pp. 60). Geneva: International Organisation for Standardisation
- Itard, L., & Meijer, F. (2008). Towards a sustainable Northern European housing stock (Vol. 22). Amsterdam: IOS.
- Konstantinou, T., Klein, T., Santin, O. G., Boess, S., & Silvester, S. (2015). AN INTEGRATED DESIGN PROCESS FOR A ZERO-ENERGY REFURBISHMENT PROTOTYPE FOR POST-WAR RESIDENTIAL BUILDINGS IN THE NETHERLANDS. Paper presented at the Smart and Sustainable Built Environment (SASBE) Conference 2015, University of Pretoria, Pretoria, South Africa.
- SER. (2013) Energieakkoord voor duurzame groei. Den Haag: SOCIAAL-ECONOMISCHE RAAD.
- Sijpheer, N. C., Borsboom, W. A., & Opstelten, I. J. (2016). Results from first "NetZero Energy" projects in the Netherlands. Paper presented at the Sustainable Built Environment 2016: Transition Zero – SBE16, Utrecht. <http://www.hu-conferenties.nl/index.php/sbe16/>
- Silvester, S. (1996). Demonstration projects and energy efficient housing. (PhD PhD), Erasmus University Rotterdam, Rotterdam.
- Stroomversnelling. (2013). Maak de stroomversnelling mee. Retrieved 23.11, 2015, from <http://www.stroomversnelling.net/over-stroomversnelling/>
- Voorbeeldwoningen. (2011). Onderzoeksverantwoording. Sittard: Agentschap NL.
- Winter, R. e. a. (1993). Evaluatie van het E'novatioprogramma (R. Advise, Trans.). In RIGO (Ed.). Amsterdam: RIGO.
- WoON2012. (2013). Energiebesparing: Een samenspel van woning en bewoner - Analy-se van de module Energie WoON 2012. Petten: ECN and RIGO.

Timber Prototype – High Performance Solid Timber Constructions

Hans Drexler¹, Oliver Bucklin², Angela Rohr¹, Oliver David Krieg², Achim Menges²

- 1 Jade Hochschule, Fachbereich Architektur, Verwaltung der Professur "Konstruieren und Energie und Gebäudetechnik", Ofener Straße 16/19, Hauptgebäude Raum E7, D-26121 Oldenburg, Tel. +49 441 7708-3785, Fax +49 441 7708-3789, hans.drexler@jade-hs.de, angela.rohr@jade-hs.de
- 2 Institute for Computational Design, University of Stuttgart, Keplerstr. 11, D-70174 Stuttgart, Tel +49 (0) 711 685 819 20, Fax +49 (0) 711 685 819 30, oliver.bucklin@icd.uni-stuttgart.de, oliver.krieg@icd.uni-stuttgart.de, achim.menges@icd.uni-stuttgart.de

Abstract

The paper presents the development of a building system made from solid timber that fulfils the requirements of modern building skins while expanding the design possibilities through innovation in computational design and digital fabrication. The strategy is to augment the comparatively high insulation values of solid timber by cutting longitudinal slits into beams, generating air chambers that further inhibit thermal conductivity. Various configurations of slits and methods of assembly are explored to find the best combination of high insulation values, structural capacity, ease of construction and design variability. A first version of the system is tested at a building component level with digital models and physical laboratory tests. It is further in a prototype building, where blower door tests and infrared imaging are used to identify issues and further refine design, fabrication and assembly methods. Results are integrated into proposals for new methods of implementation. The results of the research thus far demonstrate the validity of the strategy, and continuing research will improve its viability as a building system. The continuation of the project proposes more effective supply chains by partnering with industrial partners to rapidly produce standardized building units and integration of computational design and fabrication techniques that allow the generation of more complex forms through customizable details.

Keywords

solid timber construction, insulation, building physics, digital fabrication, architecture

1 INTRODUCTION: PRINCIPLES OF MONO-MATERIAL CONSTRUCTIONS

Current building and construction industries combine many materials from different origins. This long standing trend follows the logic that, for each specific task, a material can be found which is best suited in terms of the properties, production, construction processes and costs. With this strategy the efficiency and performance of each component can be maximized. Thus, the complexity of each part of the construction and the building as a whole is increased. However, unintended consequences follow from the complexity of hybrid constructions: (1) Despite the efficiency of each element the overall costs can be higher; (2) Maintenance and repairs also become more complicated and expensive; and (3) In addition, recycling and reusing materials and components becomes more difficult (Knaack, Klein, Bilow 2015).

At the same time, a new trend for mono-material constructions can be observed especially in brick buildings. This is supported by research suggesting new numeric models for the energy consumption of buildings, which emphasis the thermal storage capacities over the insulation (Tersluisen & Nasollahi 2016). As a built example for this trend the building of Baumschlager Eberle 2226 in Lustenau can be named, which uses a monolithic brick wall of 76 cm thickness consisting of two different types of bricks (Baunetz Wissen 2016). The building manages to be operated in a convenient temperature range without active heating systems. Other examples can be found in monolithic concrete construction which use ultralight concrete, or 'Infra-Lightweight Concrete', to achieve the necessary insulation (Schlaich & El Zaire 2008). Here, the concrete weight is reduced to 800kg/m³ by adding porous materials. The same approach can be seen in timber construction in the last years, where solid building elements are thermally activated and used as insulation and structure at the same time.

2 INTRODUCTION: BUILDING SYSTEM PRINCIPLES OF TIMBER-ONLY CONSTRUCTION

Solid timber has many advantages in comparison to other standard construction materials. Timber requires less energy than concrete or steel for its production (Gordon 2003), which reduces overhead and operating costs of building with wood. As a renewable resource, and given its negative carbon footprint and low embodied energy (Alcorn 1996, Kolb 2008), timber plays a central role in the current discourse on carbon-neutral, energy and resource-efficient construction. The development of new timber construction techniques has focused mainly on hybridization of wood products with other materials to improve the bearing capacity (timber and steel or wood-steel-concrete) and fire protection (timber and gypsum products and wood-concrete). A significant percentage of buildings use so-called structural timber (BSH) or sheet material (esp. OSB or plywood), which consist only partially of actual wood and gain strength from glues and binders (Hegger et al. 2005). Although these hybrid constructions have opened new markets such as the multi-story housing, the permanent binding of very different materials has led to the loss of many of the advantages of timber. With hybrid wood products, separation of the component materials is not economically feasible, and the reduction of carbon dioxide emissions from timber are largely negated by the high emissions of secondary materials such as concrete or steel. Solid timber is much more readily reused, recycled, or consumed as a source of compost or energy. Much of the waste (about 53% in 2012 in Germany) is generated in the construction industry for erecting and refurbishing buildings (Statistisches Bundesamt 2016).

Timber-only systems are therefore an interesting alternative for efficient and sustainable buildings. One notable system is the 'Holz 100' by the Austrian company Thoma (Thoma 2003). This system is based on layering smaller timber profiles in a diagonal pattern. The layers are connected by a regular grid of beech dowels, making the main part of the construction also mono-material. The system achieves a lambda-value of 0,078 w/mK, which is significantly higher than that of solid timber with a lambda-value of 0,13 w/mK for most softwoods. There are other solid timber systems available with similar properties but less material integrity. Limitations of the 'Holz100' systems can be seen in the insulation. In order to comply to the high European energy standards, in this case Passivhaus standard, the 'Woodcube' building in Hamburg was built with a wall construction of 290 mm wood plus 44 mm insulation and a U-value of 0,19 W/m² (Petersen & Redeem 2014). The design of the timber members in the presented research project further develops ideas for contemporary timber-only building systems (Fig. 1).

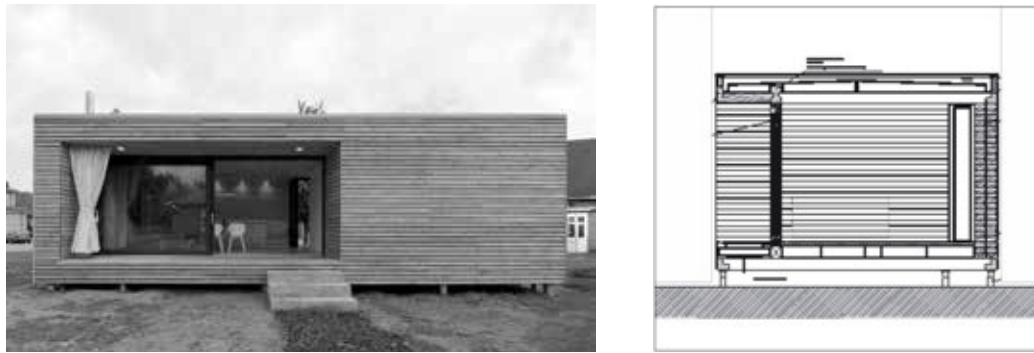

FIG. 1 The first demonstrator building 'Timber Prototype 1' built at the Munster School of Architecture (MSA) evaluating the advantages of timber-only construction systems.

3 CONSTRUCTION SYSTEM DEVELOPMENT

The approach of a timber-only construction offers the possibility to integrate insulation and heat storage in a single component (Fig. 2). The results of the research project should culminate in the design of a building system that optimally utilizes the material properties and thus provides a balance of structural performance, insulation and storage capacity. A first demonstrator was built in 2012 in order to evaluate the first iteration of the construction system on a larger scale. The paper also presents further development of the construction system, for which a second demonstrator is currently planned.

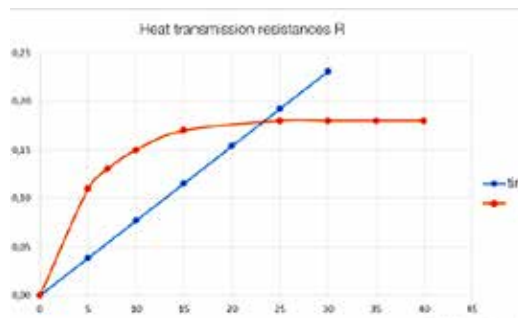

FIG. 2 Heat transmission resistance comparison between solid hardwood and stationary air according to DIN6946-6.



FIG. 3 Thermal transmission of slit timber beam in sectional view

3.1 BASIC BUILDING SYSTEM (TP 1)

The traditional timber building method, which stacks solid horizontal members and interlocks them in the corners, provides insufficient insulation for contemporary buildings. Therefore, during the development of the first demonstrator, called ‘Timber Prototype 1’, the traditional construction was augmented by cutting slits lengthwise into the timber members which produce air cavities (Fig. 3). The intent was to improve the thermal insulation of timber by increasing the air content in the timber members, since air has a lower thermal conductivity than timber. The capacity for insulation depends on the geometry, size and orientation of the air cavities. By carefully calibrating these parameters, the circulation of air (convection) that transports heat energy from the warmer to the cooler side of the cavity could be minimized. Figure 2 suggests that the size of these air cavities should be less than 15 mm in the direction of the heat transmission. Therefore, the hypothesis of the project is that as many slits as possible with the smallest possible volume will create the best insulation values. During the entire project, full scale prototype components (wall, ceiling, roof, floor) are fabricated and tested in both laboratory and onsite.

3.1.1 Construction Elements

The construction was developed as a contemporary block construction. Dimensions of vertical and horizontal elements are determined by the required thermal insulation values. Commercially available solid timber beams would not provide the depth required to achieve necessary insulation values. Therefore, the width of the walls, ceiling and floors was increased to a total of 400 mm by using two layers of modified solid timber beams, cut from standard dimension profiles of 200 x 100 mm. The width of air slots is determined by the dimension of the saw blade. The connection between the horizontal layers was secured by a groove and notch system at each end on the profiles. The wall as a whole was constructed using threaded rods with springs, which tighten the layers while allowing the timber elements to shrink and expand when its moisture content changes (Fig. 4).

A structural analysis of the construction was conducted as part of the planning application. Since only 40% of the wood volume has been removed when cutting the slits, the remaining material had enough strength to support vertical elements. For multi-story buildings, the compression orthogonal to the direction of the fibre will likely become a limiting factor. In the first demonstrator built with this construction system, ceiling and floor elements are all made with the same method. However, they do have a load bearing and cross bracing function in the overall structural system. For a single story building the structural forces within all timber members are within load bearing capacity. For horizontal elements (floor and ceiling) ten members were combined into a building component of 100 cm in width.

In order to be able to span between 4,5m and 5,5m each element is equipped with a solid edge beam on either side of the same dimension. The slit timber beams in between were not included for the structural calculation. Their softness proved challenging as the slits reduce the structural integrity, leaving it flexible and compressible. Therefore, in the final construction of the ceiling and floor a secondary layer of OSB 21 mm had to be introduced in order to distribute the loads more evenly into the construction.



FIG. 4 Elements being assembled into a wall segment (photographed by Hans Drexler and Alexander Quiring, MSA 2012)

3.1.2 Fabrication

The timber profiles have been produced on a small milling machine, where four grooves can be cut in parallel. Each of the profiles had to be milled 8 times resulting in a production time of roughly 88 hours for 15300 m of profiles in total (Fig. 5). In the next stage of the project this process will be translated to an industrial production process. Sawmill and moulding factories use large scale machinery with multiple saw blades capable of simultaneously processing both sides at high speeds.

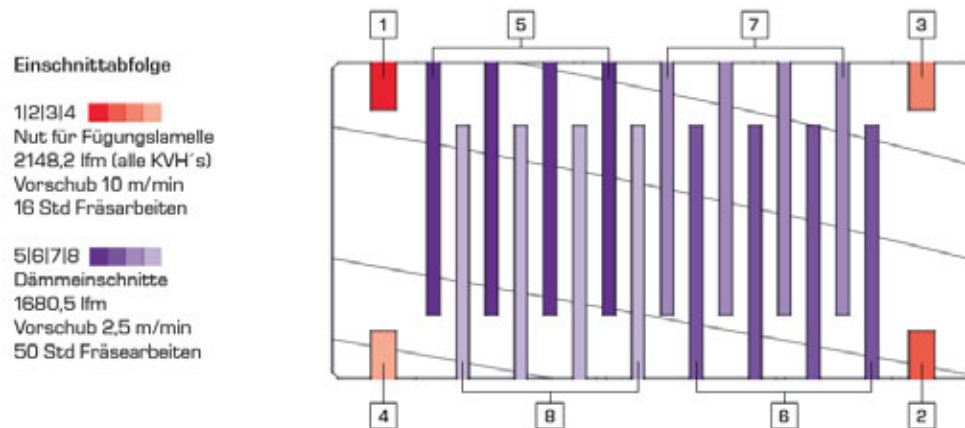

FIG. 5 The production process of timber members for 'Timber Prototype 1' is divided into several steps (Drawing by Rene Stegmann, MSA 2012)

3.2 EXTENDED BUILDING SYSTEM

In a second research project the building system will be further developed by taking advantage of the insulation capacity while integrating digital design and fabrication techniques for an extended design space. A second demonstrator is planned to be built in 2017. Given the success of the first demonstrator, the authors aim to develop design systems that take advantage of the proven insulating properties of the technology while expanding formal capabilities in order to demonstrate a broad versatility of practical implementation. This requires a combined effort that creates opportunity for new architectural articulation while optimizing physical performance. Starting with the timber unit developed described in chapter 4.1, the project explores how the individual building unit itself could inform potential formal manipulations.

3.2.1 Construction Elements

In order to minimize the joints, and thus, the potential points of air ingress, the further development of the system focuses on the timber beam as a linear block unit. The modules can be rapidly produced as standardized units that are then joined with custom details to generate architectural form. Similar to traditional masonry construction methods, as the units are aggregated, a gradual offset of individual blocks can generate various global geometries. The linearity of the timber unit, when aggregated in such a fashion, generates ruled surface geometries (Fig. 6). This surface can be described by two curves that determine the position of the ends of the linear unit. When these two generator curves are non-parallel, offset lines, the resulting geometric surface is a hyperbolic parabola. However, they can also be free form curves in three dimensional space.

As with traditional ceramic or concrete masonry construction, the system relies on a layer of binding material for structural connection, weather protection and airtightness. For this purpose, a custom layer is developed to create a stable joint that both generates form and structural stability. This comes in the form of a solid wood sheet with a series of raised finger elements that join with the slits in the standard beam unit (Fig. 7). These 'Key Sheets' are generated in computationally derived parametric models and contain the information needed to generate the desired global shape. They serve to stabilize the highly flexible beam units, and, depending on their orientation, may function as beams in horizontal spanning sections. Furthermore, these layers must also generate a seal to resist moisture and air penetration to maximize thermal performance. While the key sheets will be critical to prevent air gaps, it will also be important to minimize prolonged water contact on the exterior surfaces of the structure due to precipitation. A secondary system of overlapping planks is proposed to help shed liquid water from exterior surfaces. These elements will run the length of the primary beams and will integrate with the joinery system.

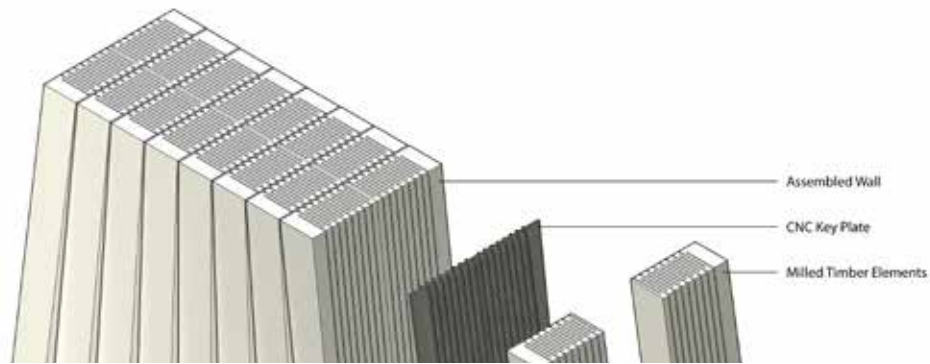

FIG. 6 Isometric view of an assembly from multiple linear units generating a ruled surface geometry

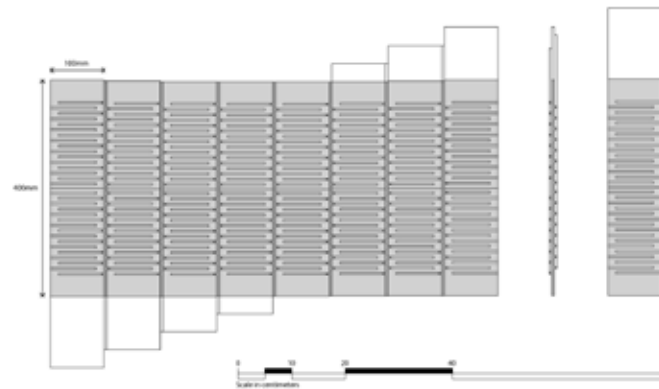

FIG. 7 Sectional top view of the building system, with an exploded view of the key sheet between two layers of linear beams

3.2.2 Fabrication

The prototypical production process makes strategic use of the available machining technology in the production of a module. The beams are milled on an industrial scale electric planer with a modified tool head that can simultaneously cut multiple slits. A standard unit size allows all pieces to be rapidly milled on this machine. Beam profiles use a standard cut pattern with regularly spaced strips and leave a solid profile end to accommodate for offsets between adjacent units in the completed wall sections. The key sheet geometry is generated individually through computational models that directly output machine code. They are fabricated on a three-axis CNC mill in a two-sided operation in which each piece is flipped during milling. All pieces are systematically tagged to ensure correct assembly order. Assembly requires significant forces, and requires a series of jigs and clamps to press the various components together into larger building assemblies. The assemblies are limited to transportable dimensions so that the sections can be rapidly assembled onsite.

The first prototype was constrained to an analogue production process which combined manual labour with simple machinery. This experience suggested a division of manufacturing in standardized, repetitive members and detail-dependent individual connections: Through spindle moulders, planers and saws, uniform formations can always be achieved quickly and efficiently while preserving the insulating function. For the production of individual joint geometries CNC-machining methods were evaluated. They allow the production to be cost-effective and flexible.

3.2.3 Design

The integration of Computational methods allows for an expansion of the potential design space of the system. In addition to thermodynamic modelling used to predict insulation performance, spring mesh simulation models are used to evaluate physical bending behaviour of beams and to develop the keyed strips used to bind them. Parametric modelling is used to precisely determine resultant geometry based on standard lumber stock dimensions. This helps minimize time and resources put into fabrication through standardization and industrial scale production where appropriate. Elements that require precise and non-standardized machining are developed in the same parametric models that can instantly output fabrication data for rapid prototyping. This integrated, computational process allows for a smooth work process through design, analysis, fabrication and assembly. Multiple factors will be integrated in order to develop computational tools that will aid in the design and fabrication of a second demonstrator building. These factors include building physics, structural capacity, machinability, ease of assembly, cost, formal expression and architectural program. All of these factors are inextricably linked, and will be addresses through custom scripting components that strike an effective balance between formal desires, building performance, and construction realities.

Certain limitations of the building system are established, and will be productive constraints for generation of form. When the beams are aggregated, their orthogonal profile causes the ruled surface geometry to require a strong linear orientation. The simplest solution is to maintain a relatively linear orientation of the building assemblies, which will require relatively simple modular joints between sections. If it becomes necessary to change the axis along which beams are oriented, corner details must be developed that can accommodate complex angled interfaces between units. Beams offsets used to generate ruled surfaces must be minimized as they effectively decrease the total wall thickness by double the offset amount, which would greatly reduce insulation values. Surfaces that are likely to receive large water loads must have a protective water shedding layer, which means that the underlying beams should not cross along their length, which would force the overlap to switch orientation, creating a weak point in the waterproofing. In addition, beams should not be completely horizontal to prevent pooling of water. These are just a few of the main constraints that will inform the algorithmic processes by which form is generated.

3.2.4 Structural Performance

A key improvement of the new building system is the general orientation of all building elements in accordance to the main load bearing direction. In the ruled surface geometries of the wall elements, the main fibre direction is vertical. On a local level, the loads can be transferred along the fibre direction and therefore make efficient use of the material capacity. On a global level, ruled surface geometries are structurally more stable due to their curved connection to roof or floor elements. The usually three-dimensional curve describing the edge between horizontal and vertical elements is mostly experiencing tension and compression loads, compared to straight edges that have to be designed for high bending moments. The global depth that results from the ruled surface geometry also cross-braces the wall elements.

4 BUILDING PHYSICS EVALUATION

4.1 THERMAL INSULATION

In a first step, the thermal properties of the first iteration of the building system used in the demonstrator 'Timber Prototype 1' were modelled with the heat requirement calculation programme URSA V3.2.0.0. In a second step, the thermal properties were examined and compared to the thermal properties of solid timber block construction. A digital model of a simple flat roof building in the dimensions 3000 mm x 9000 mm x 3000 mm was modelled with the heat requirement calculation programme ZUB Helena Ultra v7.43. The results were found to be consistent with the calculations from the first step. The aim was to determine the thermal transfer coefficients (U-values) of the walls, floor plate and flat roof separately and whether such a small building as a whole would fulfil German energy efficiency standards as regulated by the German Energy Efficiency Decree (Energieeinsparverordnung 2014, or EnEV2014, based on European standards).

In order to achieve the necessary insulation, two layers of timber each 20 cm in width had to be combined. For water protection, a ventilated timber façade was also added. This improved the U-value significantly from 0,281 W/m²K for a wall construction of 44cm solid timber to 0,206 W/m²K.

The thermal transmittance of each variation was compared to the thermal transmittance of a continuous timber construction and to the U-value used for the reference building according to EnEV2014 (Table 1). For simplicity, external wall constructions only are shown here.

CONSTRUCTION TYPE		WITH NON-VENTILATED AIR CHAMBERS				
Wall construction type	Reference building EnEV2014	Insulated vertically perforated brick (1)	Timber frame construction (2)	Solid timber	TP1	TP1 Min (3)
Thickness in mm	n.a.	330	162	440	446	320
U-value in W/m ² K	0.28	0.253	0.274	0.281	0.211	0.270
# of air cavities	n.a.	n.a.	n.a.	n.a.	28	20

TABLE 1 Wall construction types compared to variations the developed building system.

- 1) Wall construction (from inside to outside): 10 mm plaster, 300 mm vertically perforated brick with insulated cavities, 20 mm plaster
- 2) WWall construction (from inside to outside): 9.5 mm plasterboard, 12.5 mm OSB, 100 mm timber frame construction with rock wool insulation (0.035 W/mK), 40 mm softboard
- 3) Minimum thickness to fulfil German Energy Efficiency Decree for the above described non-residential building

Furthermore, the minimum thickness of 'Timber Prototype I' to achieve a U-value of 0,28 W/m²K was determined. A minimum of 10 air chambers per beam are necessary, with 3 mm thick air chambers and 7 mm thick timber layers between chambers. The minimum thickness of the wall amounts to 320 mm. Calculating with non-ventilated air chambers, the wall may be 27% thinner than a continuous timber beam wall. Four further variations of the same structural compositions but with ventilated air chambers with a slow air flow were modelled. When a slow air flow is allowed for, the resulting U-values at the same construction thickness are approx. 22% higher. The minimum number of air chambers necessary to fulfil German energy efficiency regulations increases from 10 to 13. Additionally, without glue joints or other air proof connections between timber layers, the air chambers are likely not to be airtight. This may result in reduced thermal performance, even though convection in such narrow cavities is likely to be reduced. Further research on the air tightness of the construction system will be necessary.

For the roof and floor the insulation had to be improved due to the requirements in German Energy-efficiency Regulations for Buildings (EnEV 2009, limited to $U = 0,20 \text{ W/m}^2\text{K}$), which could have been achieved by the system. Due to the shape of the building with a large roof and floor area, the overall heat demand is largely determined by these components. The calculations indicated that in order to achieve the required insulation values, a third layer of the insulation timber could be added, resulting in a height of 60cm for the floor and roof. Instead, in 'Timber Prototype I', a more efficient cellulose derived insulation was added. The main advantage was that this layer could also be used to generate the necessary roof incline.

5 AIR TIGHTNESS

A central problem of all block constructions is air tightness. Layering single members leads to significantly more horizontal joints than in a timber-frame construction with continuous cladding and sealed joints or in brick walls, where air tightness is achieved by mortar and a continuous layer of plaster usually on the interior wall surface. In traditional and modern block constructions this problem has been addressed by introducing more or less complex tongue and groove joints between the layers. In the first demonstrator a 'BlowerDoor' test was conducted to test the air tightness of the building and detect leakages. The average measured air change per hour at 50Pa pressure difference was 6,2 1/h. However, the building was insufficiently air tight due to a variety of factors: Connection details on site were executed by students, lacking professional construction experience. Irrespective of the construction system, significant air leakages were detected on the opening joints of the large scale sliding windows and the air duct lead-in from the heat pump. The decentralized ventilation systems were sealed with masking tape, but air passed underneath into the wall construction. The same phenomenon occurred around the exhaust pipe of the wood burner.

5.1 MOISTURE PROTECTION

A challenge of the building system in the first demonstrator was rain and wind on the outer surface of the walls due to the horizontality of the joints. When joints are not perfectly sealed water will penetrate the horizontal joints and accumulate in the cavities. The ingress of water due to strong rain and wind is difficult to predict. Liquid water inside the timber construction quickly causes decay, fungal infestation, and irreversible damage. Therefore, moisture protection has the highest priority in timber construction. In the case of the 'Timber Prototype 1' the inner wall construction was protected by an additional ventilated timber facade. With respect to simplicity and a higher level of integrity it would be best if the additional facade became unnecessary. Different designs have been studied that would include an overlapping dripping edge in the shape of the outer profiles. This has not been implemented in the first demonstrator because of the high volume of wood that would have been removed to achieved the dripping edge.

6 CONCLUSION

While the first demonstrator 'Timber Prototype 1' evaluated the principle building physics as well as the structural integrity of the building system, the continuing development is focused on the possibilities of digital design and fabrication. Current digital technologies enable the exploration of an extended design space within the constraints of German energy efficiency standards. The building physics evaluation of the first demonstrator indicate that the necessary insulation for a contemporary building is not in opposition to a higher level of architectural expression. Most importantly, the innovative design allows to integrate the structural and constructive performance into the system. In the newly developed building system, connections between the individual timber members as well as larger assemblies can be achieved without the need for metal connectors. As a result, a construction method will be developed, which has the potential of being a mono-material timber construction and at the same time achieving an integral solution for the physical and structural performance of a contemporary building skin.

7 OUTLOOK

An ongoing discussion within the research team is addressing the transferability of the building system for more conventional building typologies. Planar building elements and orthogonal constructions are far more common than curved geometries. The main advantage of the newly developed building system is seen in its adaptability. Through the parametrically adapted key sheets between each layer of slit beams, wall elements can be curved but also straight and planar. However, it is worth noting that one of the main advantages of the system - its stiffness and self-stabilizing cross-bracing - can only be achieved with a more complex double curved geometry. Using the system for a planar geometry will make it necessary to introduce more powerful joints between the elements and additional cross-bracing.

Acknowledgement

The authors would like to extend their gratitude to everyone involved in the research projects. The current project is funded by Germany's Federal Institute for Research on Building, Urban Affairs and Spatial Development (BBSR). The demonstrator will be realized in partnership with the International Building Exhibition IBA Thüringen between 2017 and 2018.

References

- Alcorn, A. (1996). *Embodied Energy Coefficients of Building Materials*. Wellington: Centre for Building Performance Research, Victoria University of Wellington.
- Baunetz (2016), Bürohaus 2226 in Lustenau, http://www.baunetzwissen.de/objektartikel/Mauerwerk-Buerohaus-2226-in-Lustenau_3421609.html (accessed on 31.10.2016)
- EnEV2014 (2014). *Energieeinsparverordnung 2014, German Energy Efficiency Decree 2014*, non-official reading version of the 2. Decree for the Alteration of the German Energy Efficiency Decree, 16th of October 2013.
- Gordon, J.E. (2003). *Structures: Or Why Things Don't Fall Down*. Cambridge: DaCapo Press.
- Hegger, M., Auch-Schwelk, V., Fuchs, M., Rosenkranz, T. (2005). *Construction Materials Manual*. Berlin: Birkhäuser.
- Knaack, U., Klein, T., Bilow, M. (2015). *Imagine No. 08: Concretable*. Rotterdam: nai010 publishers.
- Kolb, J. (2008). *Systems in Timber Engineering: Load-Bearing Structures and Component Layers*. Basel: Birkhäuser.
- Petersen, J.-P., Redeem, C. (2014). *Smart Material House WOODCUBE*. Internationale Bauausstellung Hamburg.
- Schlaich, M. & El Zaire, M. (2008). *Infraleichtbeton*, in *Beton- und Stahlbetonbau 04/2008*, Berlin.
- Statistisches Bundesamt (2016). *Bau- und Abbruchabfälle 2016*, <https://www.destatis.de/DE/ZahlenFakten/GesamtwirtschaftUmwelt/Umwelt/UmweltstatistischeErhebungen/Abfallwirtschaft/Tabellen/TabellenAbfallbilanzKurzebersicht.html> (accessed on 31.10.2016)
- Tersluisen, A. & Nasrollahi, K. (2016). *Untersuchung zeitgemäßer, monolithischer Wandaufbauten hinsichtlich bauphysikalischer, ökologischer und ökonomischer Eigenschaften*. Forschungsprojekt SWD 10.08.18.7-15.34, Technische Universität Kaiserslautern.

Thoma, E. (2008). Vollholz Häuser: Das Baum-Prinzip für naturnahes Wohnen. Wien: Brandstätter Verlag.
ZUB Helena Ultra v7.43 Heat requirement calculation programme based on DIN V 18599, developed by Fraunhofer-Gesellschaft zur Förderung der angewandten Forschung e.V., Fraunhofer-Institut für Bauphysik, Nobelstrasse 12, 70569 Stuttgart.
Software URSA U-Wert, URSA Deutschland GmbH, D-04509 Delitzsch; U-Wert according to EnEV 2009 and DIN EN ISO 6946; Condensation assessment (Glaser-Method) nach DIN 4108-3; <http://www.ursa.de/de-de/verarbeiter/seiten/software.aspx>

Powerskin – Fully Fashioned*

Claudia Lüling¹, Iva Richter²

- 1 Prof. Claudia Lüling, FFin Frankfurter Forschungsinstitut, FRA-UAS (Frankfurt University of Applied Sciences), Nibelungenplatz 1, 60318 Frankfurt, tel. no +49 (0)69 – 15332768, fax no. +49 (0)69 – 15332374, e-mail clue@fb1.fra-uas.de
- 2 Dip.-Ing Iva Richter, FFin Frankfurter Forschungsinstitut, FRA-UAS (Frankfurt University of Applied Sciences), Nibelungenplatz 1, 60318 Frankfurt, tel. no +49 (0)69 – 15333654, fax no. +49 (0)69 – 15332374, e-mail i.richter@fb1.fra-uas.de

Abstract

"Powerskin - Fully Fashioned" is about lightweight design and new textile based building skins. Fully fashioned refers to a textile production technology wherein all parts of a piece of cloth are produced in one integrated production process, ready to wear the moment they leave the machine. Fully fashioned powerskin in an architectural sense implies a light, highly prefabricated textile envelope with minimum needs of installation work on the building site. It can be used for façade construction in terms of modules as well as for temporary housing structures as a whole.

To develop these new textile powerskins, experimental student works and applied research projects at Frankfurt University of Applied Science investigate the potential of the combination of textile technologies with foaming technologies. This paper focuses on so called spacer fabrics and a research project called 3dTEX and founded by Zukunft Bau, where wall elements from foamed spacer fabrics presently are under development. The aim of the paper is to present 3dTEX within the context of the accompanying experimental student design works and to show the so far achieved results for a prefabricated, lightweight, self supporting and highly insulated foamed textile skin, with reduced needs of installation work on the building site. This has been achieved by using the spacer fabric as lost formwork and using 3d-textile technologies, so as woven or warp-knitted spacer fabrics, in order to receive complex geometrical sandwich-like textiles. Together with the foam they become FabricFoam©. The new selfsupporting building elements not only offer possibilities for complex architectural geometries including loadbearing structures, but also a wide range of surface designs in terms of structures, colours and additional functionalities. The focus of 3dTEX is on the development of appropriate textile geometries for one or two layer textile elements - depending on the chosen textile technologies. Foamed, they become light-weight, insulated elements, where the two layer textile can even be transformed into a ready-made, rear-ventilated, insulated wall element made from gradient fibre and foam material, able to absorb tensile and compressive forces at the same time.

The challenge for 3dTEX is to close the knowledge gap about what kind of textile technology can produce the envisioned textile geometry with which kind of fibre material. Further, 3dTEX research is about the appropriate, possibly in-situ, foaming technology and foam material, so that fibre and foam materials match in terms of mechanical and building physics as well as in terms of grey energy and recycling aspects.

Keywords

lightweight design, prefabricated textile envelope, façade construction, temporary housing, foamed spacer fabrics, FabricFoam©

- * Full paper published in JFDE / Journal of Façade Design and Engineering, Volume 5, Number 1, 2017.
DOI 10.7480/jfde.2017.1.1526

Solar Concentrating Façade

Sidi Mohamed Ezzahiri¹, Badia S. Nasif¹, Jan Krieg¹, Anco Bakker¹, Carlos Infante Ferreira²

- 1 Fasolar B.V., Marconiweg 1, 4207 HH Gorinchem, The Netherlands, +31 683231984, Mohamed.Ezzahiri@solfence.nl
- 2 Delft University of Technology, Process & Energy Laboratory, Leeghwaterstraat 39, 2628 CB Delft, The Netherlands, +31 152784894, C.A.InfanteFerreira@tudelft.nl

Abstract

The search for renewable energy sources is a wide area in which significant progress is still expected. This paper focuses on an energy system that uses Fresnel lenses to concentrate sunlight on a tubing system to heat up the working fluid. Fresnel lenses are lighter, thinner and cheaper to build than ordinary lenses. The model is designed to be integrated into the façade of a building that will then be heated or cooled using the energy extracted from sunlight. Details of the concept have been given in Tsoutsou et al. (2014) in which the viability of the concept was investigated and its energy saving and economic benefits have been quantified. A prototype façade of 1.5 x 3.6m, with 3 m² Fresnel lens area, has been constructed as a proto-type and tested in a standard office size of a dummy building. This paper presents the experimental performance of the solar concentrating façade and identifies advantages and disadvantages of the solar system. A model has been developed to predict the effect of design choices. This model is used to identify potential optimization strategies. In addition to the sun-tracking method, mass flow through the collectors can be adjusted to achieve maximum efficiency of the Fresnel collectors

Keywords

Building integrated solar collector, Building integrated solar façade, Fresnel solar collector, Concentrated solar collector

1 INTRODUCTION

The ambition of the European Union to develop more sustainable communities has resulted in defining targets to be achieved by 2020 and beyond. Such as the EU target set for 2030. The latter require at least 40% cut in greenhouse gas emissions compared with 1990; at least 27% of total energy consumption from renewable energy; at least 27% increase in energy efficiency. As reported in the Strategic Research and Innovation Agenda for Renewable Heating & Cooling from the Renewable Heating and Cooling Platform (Sanner et al., 2013), in 2010, heating and cooling accounted for 47% of the final energy consumption in the EU. This Platform has identified that 50% of the heating & cooling energy requirements could, by 2030, be generated by using renewable energy technologies. However, the contribution of renewable heating and cooling to the EU energy targets by 2030 and beyond will be determined by the availability of reliable, efficient and affordable technology. The Platform proposes to expand the market for solar thermal applications (among others) by achieving significant breakthrough through and developing more advancement in renewable heating and cooling technology. EU's Horizon 2020 indicates that nearly 40% of the final energy consumption takes place in houses, offices, shops and other buildings. This corresponds to 30% of the generated greenhouse gas emissions. The use of renewable heating and cooling and integrated solutions have been identified as key activities potentially with the biggest impact. The solar concentrating façade presented in this paper addresses these targets by developing reliable, efficient and affordable technology which can achieve these targets when implemented in an adequate scale. By implementing the proposed solar concentrating façade, the shell of residential or office buildings is used more efficiently to collect renewable (solar) energy. Systems using renewable energy, such as solar thermal systems in buildings, can be applied to cover water heating, space heating, cooling and other energy needs in order to achieve the above mentioned challenging targets.

Recently O'Hegarty et al. (2016) have reviewed and analyzed different solar thermal façade concepts. According to these authors novel solar thermal façade solutions include solar collectors integrated into balcony rails, shading devices, louvers, windows or gutters. Similarly to the Robin Sun solar thermal glass discussed by these authors, the proposed solar concentrating façade provides insulation, shading and a hot working fluid. This hot stream can be used to drive double-effect absorption chillers / heat pumps or directly be used for heating of the building or tap water. The proposed system consists of a double façade whereby it allows the sun rays to penetrate in the winter; while it minimizes the internal solar gains in the summer. Also Zhang et al. (2015) report on emerging building integrated solar thermal technologies and include the window-based active solar thermal façades which preferably make use of metal plates with a selective treatment as solar collectors and make use of a fluid circuit adhering to the absorber. These authors set the advantages of the solar thermal façade integrated into windows:

- If the renewable energy component is placed within cavity of glazing unit, it has no impact on life expectancy;
 - Regulating the visual relations inside/outside and the supply of daylight and passive solar gains;
 - High degree of pre-fabrication possible;
- The disadvantages have been considered as follows:
- Low light transmission through renewable energy components.
 - Additional moveable shading unit / element in clear vision area is necessary.
 - Potential risks in reducing the life expectancy of the solar panel include water leakage, thermal breakage and expansion due to high temperature.

Zhang et al. (2015) also only reported on the Robin Sun concept as solar thermal façade integrated within windows. They reported that optical efficiencies (collector's thermal efficiency with no consideration of the losses by convection and radiation) in the range of 0.70-0.90 and typical solar yields for domestic hot water of 669 kWh/m² which is the highest value for the reported technologies. The system uses evacuated tube collectors.

This paper focuses on a solar thermal system that uses linear non-imaging Fresnel lenses (FL) to concentrate sunlight on a tubing system in order to heat up a working fluid (WF). Fresnel lenses are lighter, thinner and cheaper to build than ordinary lenses. The system is designed to be integrated into the façade of a building, effectively extracting energy from the sunlight to use for heating or cooling purposes. The viability of such a system has been investigated and found to be of great potential. A simplified prototype has recently been built for which the efficiency and optimal mass flow can be analyzed. In this paper, a mathematical model of the system is introduced in order to identify its performance. Experiments have been conducted using the prototype in order to validate the model. The model is finally used to identify possible optimization strategies.

2 METHODOLOGY

The authors have designed and constructed a system in which the above listed advantages have been maintained while the disadvantages have been avoided as much as possible. This solar concentrating façade has then been built in a building to measure and assess its performance. It was necessary to quantify the effect of the Fresnel lenses (that function as shading elements) on the natural lighting of the building. The Fresnel lenses are translucent. In principle, they would marginally reduce the natural day light passing through the façade skin into the building. An identical façade without the solar collectors has been installed next to the solar concentrating façade that serves as a reference façade.

The Fresnel lens system (FLS) consists of 11 lenses whereby each lens focuses the sunlight on a heat collection element (HCE), the heat collector is an evacuated tube which contains copper tubes transporting the working fluid (WF). The total amount of energy absorbed by the working fluid, running through the copper tubes, depends on the transmittance of the Diamond Glass Sheet (which is the external pane), glass carrier of the FL and the evacuated tube, among other factors (Fig. 1).

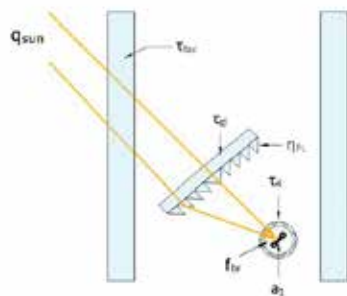

FIG. 1 View of the façade including the HCE. Left: schematic showing a single lens; Right: detail of the façade illustrating the transparency and shading effect of the façade.

The external Diamond glass sheet covering the FLS serves as the outer protective barrier to prevent environmental influences such as wind, dust, polluting particles and rain. These would have severe impact on the operation and performance of the system. The internal glass sheet inside the building, would serve as a safety barrier to prevent human interaction with the absorbing tubes. These contain a high temperature working fluid.

The external glass sheet is made of a High Grade, Ultra Clear transparent glass to maximize the transmittance of the sunlight. Even when this glass is used, not all of the solar energy incident on this glass, will penetrate the external pane and reach the Fresnel lens. The transmittance τ_{fac} accounts for the energy losses of the sunlight passing through the external glass sheet.

The FL converges incident sunlight on the façade onto the focus line HCE. The 11 Fresnel lenses of the system are composed of two parts that are laminated together. There are the actual lens and a thin layer of glass to increase robustness. Similar to the façade, this layer causes a loss of solar energy.

The HCE is the part of the system that absorbs the incident solar energy and transfers it into the working fluid (WF). The solar radiation incident on each of the 11 Fresnel lenses is focused onto its corresponding HCE. The WF absorbs the solar radiation while flowing through the absorbing tubes, entering in one tube and leaving through the other. The absorbing tubes are made of copper and are treated with a selective coating, which increases the absorptance for radiation in the solar energy spectrum and reduces the emissivity. The evacuated tube is made of glass with a high transmittance.

Apart from the heat losses of the FLS described in the previous section, some additional losses have to be accounted for. Firstly, the HCE are supported on one side by support brackets. It is very complex to determine the exact loss of energy these brackets induce, due to various parameters. Therefore, for developing a model of the Fresnel lens system (FLS), the heat loss in the support brackets will be considered as a fraction f_{br} of the total incident radiation. Since the energy losses in the FLS follow up consecutively, they can be multiplied to form a chain of losses. The total amount of energy absorbed by the absorber is given by equation (1):

$$q_{abs} = q_{sun} \times \tau_{fac} \times \tau_{gl} \times \eta_{FL} \times \tau_a \times a_1 \times (1 - f_{br}) \quad (1)$$

With q_{sun} the incident solar radiation perpendicular to the FL, τ_{fac} transmittance of the façade, τ_{gl} the transmittance of the glass layer on the η_{FL} the efficiency of the τ_a the transmittance of the glass envelope, a_1 the absorptance of the absorber and f_{br} the fraction of heat lost in the support brackets of the HCE. The FL are vertically aligned facing south and rotate around the HCE to keep the focal line on the absorber. The WF flows through the absorber tubes from the bottom to the top of the FLS and is heated gradually while moving up. The hot WF is then circulated through a test-loop so that the inlet temperature to the system is maintained at a fixed temperature. For different solar intensities, it is investigated how the total efficiency of the cycle can be maximized. The efficiency of the FL is obtained from Gupta (1981), the absorptance a_1 of the absorber is determined by using Norton (1992) and the fraction of heat loss f_{br} in the support brackets is determined by Tsoutsou et al. (2014).

A model is developed to determine the performance of the solar concentrating façade. The model is validated with experimental data so that realistic optimization studies and experiments can be executed. The model enabled us to identify the disadvantages listed in the proposed concept and finding ways to resolve them.

3 MODEL

The system model (MATLAB) is based on conservation of mass and energy and takes the specifications of the set-up and specifically of the FLS into account. The model inputs are the solar radiation q_{sun} , m_{wf} and the temperature of the WF at the inlet of the FLS, T_{wf_in} . To analyse the behaviour of the system, it is required to predict outlet temperature T_{wf_out} and the pressure drop as the WF passes the FLS. By changing the m_{wf} for different values of q_{sun} , it is possible to optimize the efficiency, defined as:

$$\eta_{solar} = \frac{m_{wf} \times c_{p_wf} \times (T_{wf_out} - T_{wf_in}) - W_{pump}}{q_{sun}} \quad (2)$$

The pumping power W_{pump} that is required to overcome the pressure drop in the FLS is obtained from:

$$W_{pump} = \frac{m_{wf} \times (p_{wf_in} - p_{wf_out})}{\rho_{wf} \times \eta_{pump}} \quad (3)$$

The impact of the geometry of the HCE on the performance of the FLS is determined through a numerical model. Energy balances are derived for each of the components of the HCE (Fig. 1), from which the temperature of the WF can be obtained:

$$q_{rad_1-4} + 2 \times q_{rad_2-4} = q_{conv_4-5} + q_{rad_4-5} \quad (4)$$

Where 1, 2, 4 and 5 are different parts of the absorber system, *rad* stands for radiation and *conv* stands for convection. Similar equations apply to identify the amount of incoming solar radiation that is conducted by the absorber or is radiated to other parts of the absorber system. The temperatures of the outer surface of the absorber tubes and outer surface of the envelope are first assumed and then iterated. With eq. (4) and similar equations, all other system temperatures can be calculated.

4 EXPERIMENTAL SET-UP

A 1.5 by 3.6 m prototype façade construction, with 3 m² Fresnel lens area, has been produced, installed and tested in a dummy building with standard office size, see right hand side of Fig. 1. The façade is orientated to the south.

The test set-up (Fig. 2) consists of a gear pump (B), gate valve (C), Fresnel lens system (FLS, A), a heat exchanger (HEX, E), bypass (F) and a storage tank (D). System boundary is selected around the first three components, because the focus of this research is on the efficiency of the FLS. The WF is a specific low viscous oil that can handle high temperatures and is pumped through the system counter clockwise with a controllable mass flow.

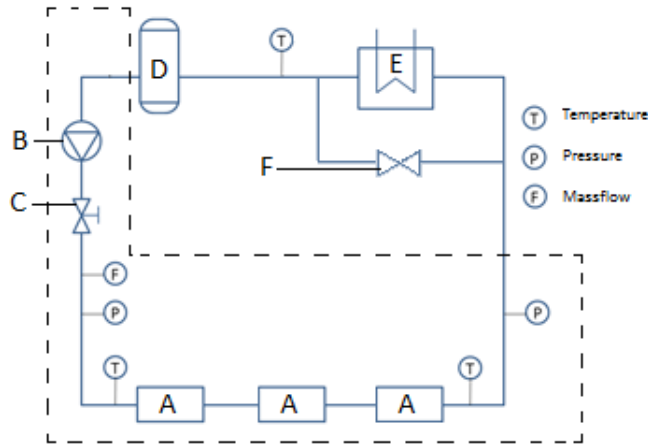

FIG. 2 Schematic overview of the experimental set-up

The experimental set-up measures the following data:

- 1) temperature of the WF entering the FLS, T_{wf_in} , temperature of the WF leaving the FLS, T_{wf_out} , temperature of the WF entering the storage tank, $T_{storage}$, temperature of the air surrounding the FL, T_{fac} ;
- 2) inlet p_{wf_in} and outlet p_{wf_out} pressure of the FLS;
- 3) volume flow, V_{wf} , of the WF;
- 4) the solar irradiance, q_{sun} , on a horizontal planar surface.

A Grant SQ2010 datalogger has been used to measure and collect data from calibrated thermocouples, pyranometer and a flowmeter. The thermocouples have an accuracy of ± 0.5 K and the pyranometer an accuracy of 10%.

During experiments the bypass valve was fully or partially closed in order to influence the temperature of the WF at the inlet of the FLS.

5 RESULTS AND DISCUSSION

Experiments have been carried out during a sunny partially cloudy day. This will enable to determine the dynamic effects (e.g. variation of solar irradiance) and impact on the performance of the FLS.

Based on experiment the heat absorbed by the working fluid Q_{abs_exp} is determined by eq. (5):

$$Q_{abs_exp} = \rho_{wf} \times V_{wf} \times c_{p_wf} \times (T_{wf_out} - T_{wf_in}) \quad (5)$$

This value is compared with the predicted value of the model Q_{abs_mod} . Results of this comparison are presented in Fig. 3.

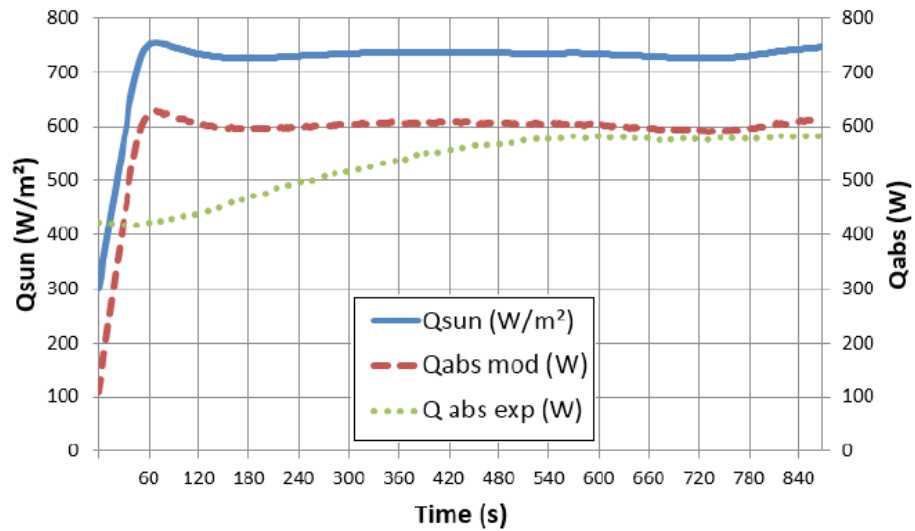

FIG. 3 Comparison of predicted and measured values of absorbed heat

Fig. 3 presents the measured solar irradiance q_{sun} , the predicted value of the absorbed heat Q_{abs_mod} and the value obtained by experiments Q_{abs_exp} . Results clearly show a convergence, between predicted and measured values after approximately 500 seconds. Fig. 3 also shows an initial large difference between predicted and measured values. Since a quasi-static mathematical model is applied, dynamic effects such as heat accumulation within the HCE are not taken into account.

The predicted pressure drop is validated by comparing the model results with the experimental data. The optimized m_{wf} , for two different values of T_{wf_in} , is depicted in Fig. 4. For every interval of values for q_{sun} , the m_{wf} leading to the highest efficiency is used. The maximum efficiency of the FLS for direct solar irradiance above 500 W/m² converges to approximately 30%.

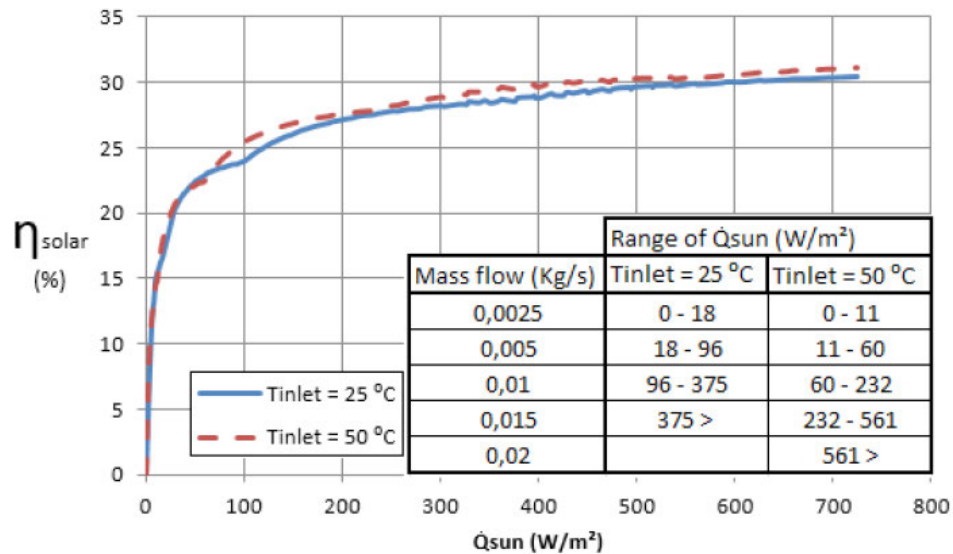

FIG. 4 System efficiency for optimized mass flows, plotted against variable solar radiation for $T_{wf_in} = 20$ oC and $T_{wf_in} = 50$ oC.

The efficiency of the FLS can further be increased by minimizing the chain of losses. There are four main loss factors to be recognized here, namely losses in the façade, losses due to shadow, losses in the lenses and losses in the absorber tube.

5.1 LOSSES IN THE FAÇADE

The FLS has a façade that consists of diamond glass. The façade is used to protect the FLS from dust and rain and to minimize interaction with the environment to reduce losses. However, the transmittance results in significant losses through reflection and absorption. Eq. (6) shows the losses through the façade:

$$q_{fac} = q_{sun} \times \tau_{fac} \quad (6)$$

with \dot{q}_{sun} the radiation from the sun and τ_{fac} the transmittance of the facade. τ_{fac} is dependent of the angle of incidence on the façade, q_{fac} . Wide angles of incidence during the summer period ($\theta_{fac_min} = 61.5^\circ$ during summer solstice, the longest day on the Northern Hemisphere) are the reason a big part of the incoming radiation is reflected instead of being transmitted when the Sun reaches it's highest altitude. In winter, angles of incidence are always small, ($\theta_{fac_max} = 49.5^\circ$ during winter solstice, the shortest day on the Northern Hemisphere). This phenomenon is displayed in Fig. 5. In Fig. 5 one can see the difference in efficiency of the façade throughout the year. Around the beginning of spring (day 80) and autumn (day 264) the Sun's radiation has the ideal combination of a relatively high energy density and relative low angles of incidence. During these two periods the amount of energy that passes the facade is higher than in summer although the total irradiance as measured in the Netherlands is significantly higher, during summer as shown in Fig. 5.

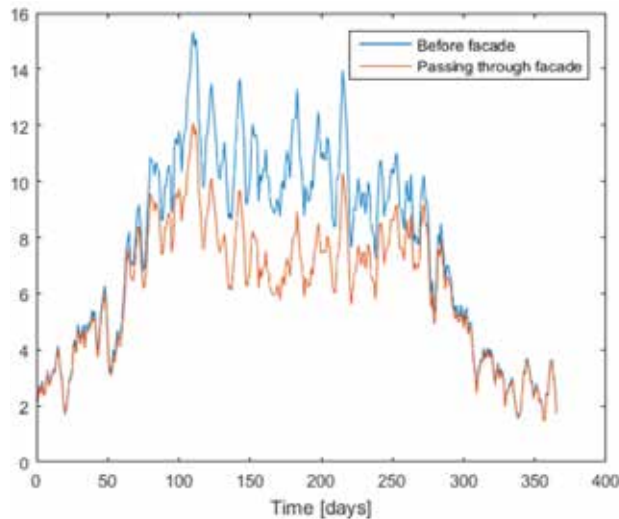

FIG. 5 Irradiance compared to total energy passing the glass façade.

Fig. 6 shows the efficiency of the façade throughout a year. Since the FLS is attached to the façade of a building facing south, it is not possible to make use of the morning and afternoon sunshine during summer, because during early morning and late afternoon the azimuth is bigger than 90°. From Fig. 5 and 6 it follows that the glass façade has a huge influence on the performance of the system but that this loss factor cannot be reduced without changing the fundamental assumption that the FLS has to be attached to a building.

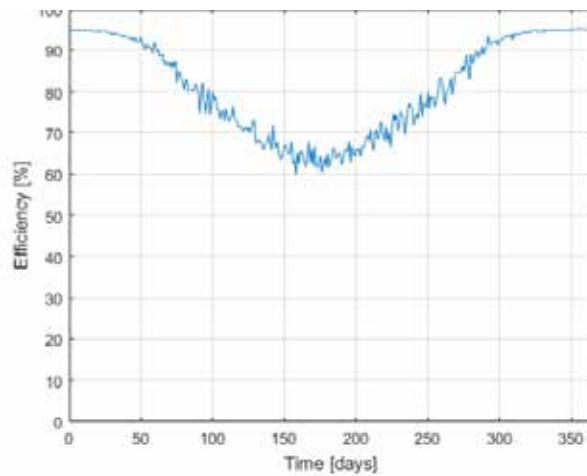

FIG. 6 Efficiency variation of the glass façade during one year.

5.2 LOSSES DUE TO SHADOW EFFECT

There are two things that cause shadow on the lenses in the current FLS. The first cause is the frame of the system. During early mornings and in the late afternoon, a high azimuth sun causes shadow on the sides of the lenses. To counter the negative effect of this shadow, a mirror can be placed on the inside of the frame. From the law of reflection it follows that the angle of reflection and angle of incidence are both equal to the angle of incidence of the sun and that the distance from the lens to the façade is on both sides equal because the lens is aligned parallel to the façade.

The second cause of shadow on the lenses is overlap. Because the lenses follow the elevation angle of the sun, they will face upwards during solar noon. The Matlab calculations show that the total area of the lens in the shadow is significant and reaches a maximum of 42%, at which point the top lens is shaded for 92% by the aluminum frame and the other lenses for 36% because of overlapping lenses. This is unfortunate, because the shadow caused by overlap is the biggest when the irradiance is the highest. Because the value of the irradiance is measured in a plane perpendicular to the irradiance, the useful area of the façade is also perpendicular to the radiation. Because the frontal area of the façade is constant, it becomes clear that useful area is only dependent on the trajectory of the sun. When there is shadow on the lenses, it means they overlap and no radiation from the sun can pass between the lenses. When no sun rays can pass between the lenses, it means the maximum surface is irradiated by the sun. Calculations show that for an elevation angle of more than 45.6° shadow starts to appear on the lenses, so for lower elevation angles some sun rays fall between the lenses and through the FLS in the building. After establishing that the total irradiance on the collector throughout the day increases with decreasing elevation angle, one could argue that it is best to have no shadow on the lenses when the elevation angle is 0 and for higher have shadow on the lenses. However, this poses questions to the losses in the absorber and the cost-efficiency. Optimizing the amount of lenses and their width to improve the overall efficiency is being investigated for the improved design of the solar concentrating façade.

5.3 LOSSES ON THE LENSES

Between a light beam reaching a lens and reaching the absorber, intensity is lost due to mainly two factors: incorrect projection on the absorber and reflection on the surface of the lens (similar to what has been discussed for the glass protection of the FLS).

The requirement to extract the maximum amount of energy from a solar beam is that every solar beam, projected on the lens, has to be projected on the collector as well. In this section the projection area is defined as a function of the angle of incidence on the lens, θ_l . As a result of the blocking effect and off-axis aberrations, the lens always has to be directed perpendicular to the height of the sun with a maximum deviation of 6° (Tsoutsou et al., 2014). The current system is able to follow the height of the sun very closely. As a result the elevation angle has no effect on the position of the projection area. The azimuth of the sun has an effect on the projection area. Because the angle of incidence is a combination of the elevation angle and the azimuth, and the lenses are always lined up with the elevation angle, the angle of incidence on the lens θ_l is equal to the azimuth of the sun. The movement of the projection area along the collector is calculated by using the law of Snellius in combination with eq. (7).

$$x_{pro} = \delta \times \tan(\theta_{int}) + f \times \tan(\theta_l) \quad (7)$$

Where δ is the thickness of the lens, θ_{int} the internal refraction angle of the lens, f the distance between the lens and collector and x_{pro} the position of the projection area along the collector. During solar noon the azimuth is 0° and therefore x_{pro} is 0, which means the projection falls precisely on the entire collector. When the azimuth is unequal to 0 the projection shifts to one side and as a result one end of the projection does not fall on the collector. It becomes clear that in the current system a significant part of the projection area does not fall on the collector during early morning and in the evening. The only way to prevent these losses and have the projection fall on the collector, is to make the position of the collector dynamic. Mirrors on the side of the facade can also help prevent these losses.

The second effect of the azimuth is a changing focus distance perpendicular to the lens. When the azimuth is high the focus distance becomes smaller and a wide and diffuse projection area is created where the collector is currently positioned. Because of the changing focus distance, the actual size of the projection area at the position of the collector varies greatly. Because the collector size is constant, the distance between collector and lens is the only variable to match the projection area and collector. This problem can be solved by making the tracking system 2-D which is under consideration in the new design of the solar concentrating façade.

6 CONCLUSIONS

Experiments executed with a prototype solar concentrating façade have indicated that most of the advantages of window-based active solar thermal façades as reported by Zhang et al. (2015) apply for the present design:

- since the double-façade is air-tight, wind, dust and rain cannot deteriorate the system;
- the FLS allow diffuse light to penetrate the working space so that the day-light penetrates sufficiently in the room;
- the double-façade can be produced in a factory and easily installed on-site;
- the present configuration functions as complete shading so that no additional shading is needed;
- the working fluid operates at low pressure reducing the risk of pressure failure.

Unfortunately its experimental solar efficiency is relatively low. An analysis of the different losses that take place in the solar collector has identified a number of causes for this level of efficiency. Investigation of these losses has indicated possible methods to improve the prototype. A large number of these effects is being implemented in a second prototype which is presently under development.

Acknowledgements

The authors would like to acknowledge the contributions of the authors of the references Rietema et al. (2015) and Braam et al. (2016) on which this paper is largely based.

References

- Braam, L., van de Kamp, W., Kooistra, H., Kosterman, A. (2016). Improving a Fresnel lens system. Delft University of Technology, Faculty of Mechanical Engineering.
- Gupta, P.K., (1981) Efficiency of Fresnel Lens, *Applied Energy*, Vol. 9, pp. 173-183.
- Norton, B., (1992) *Solar Energy Thermal Technology*, first edition, Springer-Verlag Londen Ltd.
- O'Hegarty, R., Kinnane, O., McCormack, S.J., (2016) "Review and analysis of solar thermal facades". *Solar Energy* Vol. 135, pp 408-422.
- Rietema, R., Endtz, J., Heere, D., Deurvorst, T. (2015). Concentrating solar energy for heating and cooling applications using fresnel lens technology. Delft University of Technology, Faculty of Mechanical Engineering.
- Sanner, B., Angelino, L., De Gregorio, M., Février, N., Haslinger, W., Kujbus, A., Landolina, S., Sparber, W., Stryi-Hipp, G., van Helden, W., Weiss, W. (2013) *Strategic Research and Innovation Agenda for Renewable Heating & Cooling*. RHC-Platform, Brussels.
- Tsoutsou, S., Infante Ferreira, C., Krieg, J., Ezzahiri, M., (2014) "Building integration of concentrating solar systems for heating applications. *Applied Thermal Engineering*, Vol. 70, pp 647-654.
- Zhang, X., Shen, J., Lu, Y., He, W., Xu, P., Zhao, X., Qiu, Z., Zhu, Z., Zhou, J., Dong, X., (2015) "Active Solar Thermal Facades (ASTFs): From concept, application to research questions". *Renewable and Sustainable Energy Reviews*, Vol. 50, pp. 32-63.

Viability study of Solar Chimneys in Germany – Analysis and Building Simulation

Lukas Schwan¹, Eabi Kiluthattil², Madjid Madjidi³, Thomas Auer⁴

- 1 University of Applied Science Munich, Department of Building Services Engineering, Lothstr. 34, 80335 Munich, fon: +49 89 1265-4361, fax: + 49 89 1265-4390, email: lukas.schwan@hm.edu
- 2 Technical University of Munich, Chair of Building Technology and Climate Responsive Design Arcisstr. 21, 80333 Munich, fon: +49 1575 - 1367846, fax: +49 89 289-23851, email: eabi.kiluthattil@tum.de
- 3 University of Applied Science Munich, Department of Building Services Engineering, Lothstr. 34, 80335 Munich, fon: +49 89 1265-1562, fax: +49 89 1265-1502, email: madjid.madjidi@hm.edu
- 4 Technical University of Munich, Chair of Building Technology and Climate Responsive Design, Arcisstr. 21, 80333 Munich, fon: +49 89 289-22475, fax: +49 89 289-23851, email: klima@lrz.tum.de

Abstract

This paper investigates the potential of using solar chimneys for natural ventilation in Germany. Therefore various parameters were analyzed, using a simplified three story office building according to a VDI reference building. The simulations were carried out for four locations in Germany (Munich, Hamburg, Berlin and Stuttgart) with their different weather data. The model was set up in TRNSYS using the TRNFLOW- and TRNSYS-3D-Plugins. Different variations of the model were simulated and compared to each other. General parameters, like the effect of solar radiation, ambient temperature, the effect of wind and different positions of the inlet and outlet of the solar chimney were studied. For all four locations simulations were set up with and without wind to analyze its influence and for different occupancy times. Effectiveness and range of application of these models were studied. The investigations show that solar chimneys can be used for natural ventilation in Germany. In more than 97 % of the time, the required minimum air flow can be provided for all four cities, for different occupancy times, with and even without considering wind effect. Just during a small time period in summer, the required air flow cannot be provided due to high ambient temperatures. The wind effect has a strong influence on the results and increases the effectiveness of the natural ventilation system if the outlet of the chimney is located in a zone of negative pressure.

Keywords

Natural Ventilation, Solar Chimney, Building Simulation, TRNSYS, TRNFLOW

1 INTRODUCTION

Despite the efforts to mitigate the effects of rising global greenhouse gas emissions, they have always shown a rising trend (IPCC, 2013). About one third of the greenhouse gases are emitted by buildings; which are responsible for 40 % of the global energy consumption. According to the United Nations Environment Program for Sustainable Buildings and Climate Initiative, buildings also offer the largest potential for achieving considerable reductions of greenhouse gas emissions and reduction of their energy consumption by 30% to 80 % (UNEP-SBCI, 2016).

Looking at the primary energy consumption for various building services in office buildings, almost 15% of the energy is consumed by ventilation (ENOB, 2016).

This paper explores the potential of reducing the energy demand of ventilation by proposing a more passive ventilation strategy. This concept can be based on a more efficient mechanical ventilation system or a natural ventilation system that works without power. A solar chimney could be an ideal ventilation concept that just uses the sun as the driving force and therefore uses no conventional sources of energy. A schematic of a solar chimney can be seen in Fig. 1. Solar chimneys work by absorbing solar radiation from the sun to create an air temperature gradient along the chimney resulting in a pressure difference between the chimney and the ambient air and finally in an airflow for ventilation. This pressure difference can be increased by using wind effects.

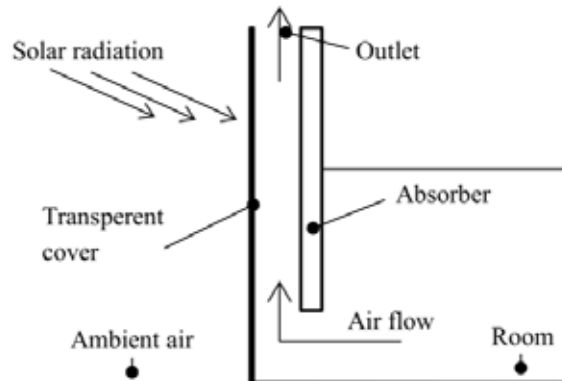

FIG. 1 Schematic of a solar chimney

Previous studies and publications have always focused on investigations of solar chimneys in hot and humid conditions (Khanal & Lei, 2011; Lal, Kaushik, & Bhargav, 2013). This paper investigates the potential of using solar chimneys in Germany for office buildings. The influence of different weather conditions are analyzed as well as the possibilities of harnessing wind effects.

2 METHODOLOGY

A solar chimney comprises of a chimney that acts as an air exhaust, with the sun as the driving force. As the chimney gets heated up due to the solar radiation, this results in an elevated temperature of the air inside of it. As air with higher temperature is lighter, it rises up enabling a lower pressure in the chimney and an effective stack effect or buoyancy effect. As the pressure inside the chimney is lower than the surroundings, this results in a flow of ambient air into the building through other openings like windows and doors. This form of ventilation is entirely passive as no external energy other than the sun is used to drive the ventilation.

To explore the feasibility of using solar chimneys in Germany, a standard building model was used as the reference. This reference building was taken from the VDI Norm 6009 (VDI 6009 - Blatt 1). The building basically is a three story office building with an underground parking. As most of the VDI norms refer to this building as a reference for various calculations, this building was considered as a suitable reference. The simulation was mainly focused on maintaining the required ventilation for the three floors comprising of office spaces, using a solar chimney for each floor.

TRNSYS and related plugins (TRNFLOW, TRNSYS-3D) were used to simulate the building under various conditions of climate, chimney inlet and outlet positions, wind and occupancy, which will be further described in this paper.

In the following chapter, the setup data, model and input variables are described as well as the investigated aspects.

3 SIMULATION AND RESEARCH

3.1 TRNSYS MODEL

TRNSYS (which stands for Transient System Simulation) is a flexible graphic based software environment used to simulate the behavior of transient systems. The unit type 56, which allows multi-zone building modelling, was used to set up the thermal model. The 3D radiation model required as an input for type 56 was drawn in TRNSYS-3D, which is a Sketchup plugin. In TRNSYS-3D the building geometry with zones, orientation and internal view factors for radiation exchange was developed.

The VDI reference building was set up as a simplified version in TRNSYS-3D, retaining the same window sizes and building geometry for the three floors. The developed model can be seen in Fig. 2. Each floor was equipped with a solar chimney for natural ventilation, attached to the south façade of the VDI reference building.

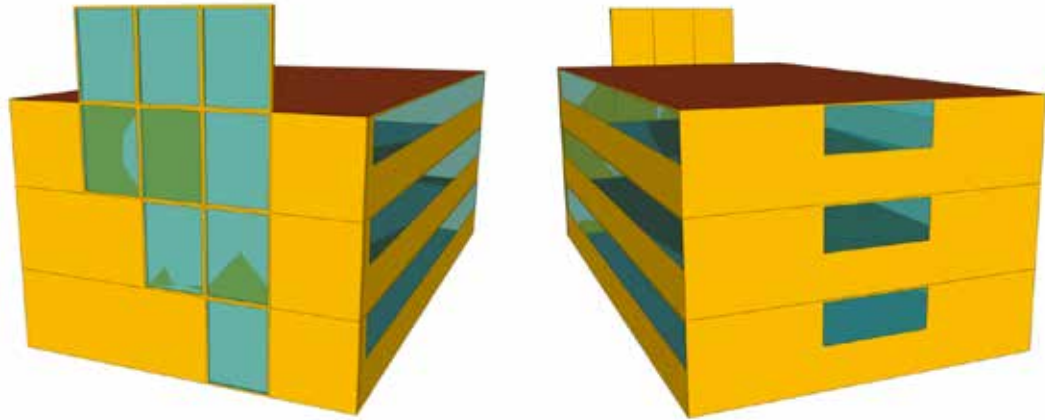

FIG. 2 Fig. 2: VDI Reference Building developed in TRNSYS-3D – view from South (left) and North (right)

The multi-zone modelling plugin in TRNSYS called TRNFLOW was used to combine the thermal model from type 56 with the airflow model. The thermal and the airflow model are linked to each other as black boxes. In the calculation process, the airflow model starts with the input node temperatures and calculates the corresponding airflows of each node. These flows are used in the thermal model, which calculates the output room temperatures. With an iterative solver algorithm, the input temperatures set can be found based on the previous results for the output temperatures set.

The German Test Reference Year (TRY) of 2010 was used as the weather model for the simulations. It summarizes the changes of climate from the period of 1988 – 2007 and takes into account the microclimate in a particular area due to elevation and heat island effect (Deutscher Wetterdienst, 2010).

The used input parameters for the building, the solar chimneys and the flow calculation in TRNFLOW can be found in the Tables 1 - 3.

PARAMETER	SYMBOL	VALUE	UNIT
Type of building	-	Office	-
Occupancy	T	06:00 to 18:00	hr
Length of building	LB	30.60	m
Width of building	WB	16.60	m
Height of building	HB	16.00	m
Window size north	AWN	9.50	m ²
Window size east & west	AWE	55.86	m ²
Area of each floor	AF	507.96	m ²
Total floor area	AF _{ges}	1523.88	m ²
Number of floors	N	3	-
Computers		1	1/Pers.
Lighting		5	W/m ²

TABLE 1 Building Parameters

PARAMETER	SYMBOL	VALUE	UNIT
Cross section area of each solar chimney	A_{sc}	0.841	m ²
Number of solar chimneys		3	-
Height of solar chimney in ground floor	H_{sc1}	12	m
Height of solar chimney in first floor	H_{sc2}	8	m
Height of solar chimney in second floor	H_{sc3}	4	m
Outlet height	H_{Outlet}	0.5	m
Outlet width	W_{Outlet}	2.9	m

TABLE 2 Solar Chimney Parameters

PARAMETER	SYMBOL	VALUE	UNIT
Min. Airflow Requirement	-	2036	m ³ /h
Temperature Set point (Heating)	-	20	°C
Time step	-	0.15	hr
Density of Air		1.204	kg/m ³
Specific Heat of Air	C_p	1.012	kJ/kgK
Ambient Air Pressure	P_0	101325	Pa
Discharge Coefficient	C_D	0.60	-
Stefan Boltzmann Constant		2.0400E-07	kJ/hm ² K ⁴

TABLE 3 TRNFLOW Parameters

3.2 AIRFLOW NETWORK

The COMIS model, integrated in TRNFLOW, was used to model the airflow network in the building. The network model of the building is implemented as an airflow network by modelling the nodes as non-linear conductances and flow components like openings as air paths. The law of conservation of mass is applied to each node to solve node pressure and mass flow.

Thermal nodes and external nodes are used in this simulation to model the airflow network. Thermal nodes are homogeneous by nature with respect to temperature, humidity, pressure etc. and correspond to the air node in the thermal model. For each air node the temperature and humidity are calculated in the corresponding thermal node and are passed on to the airflow model. External nodes are used to replicate the effect of wind pressure on the building façade. Each external node is defined by its own set of wind pressure coefficients. For each direction of wind, the dynamic pressure of the wind velocity is calculated by the external node.

The building was zoned into office space and solar chimney. Five external nodes representing the four façades and the roof were considered. Each floor is simulated as a thermal zone with one air node connected to its own chimney, comprising of one thermal zone and three air nodes via an opening at the ceiling level. The chimneys corresponding to the three floors are of equal cross sections but different heights as mentioned in Table 2. Each floor was modelled as one zone. The study of this paper is limited to the analysis of ventilation flows through the office space and does not consider the distribution of the air in the floors.

3.3 CONTROL OF VOLUME FLOW AND TEMPERATURE

The volume flow of air entering each floor was controlled by using a window control sequence, which was realized with an iterative feedback controller that uses a secant method to minimize the tracking error. The control was implemented with a set value for the amount of fresh air required in the floor, using this as the set point for the controller. The windows were modulated to maintain this flow by opening or closing. Each floor was equipped with a controller that controls three openings, i.e. the window on the north façade, which acts as the inlet, the window between the office and the solar chimney and the window at the top of the solar chimney, which acts as the outlet. An example of the control scheme for the ground floor can be seen in figure 3.

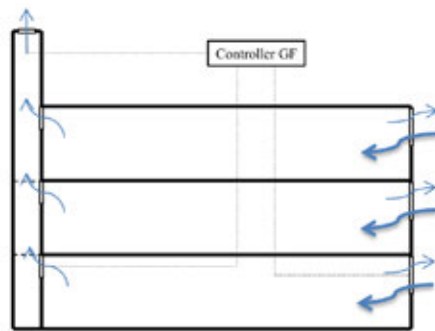

FIG. 3 Schematic of the controlled openings for the ground floor (GF)

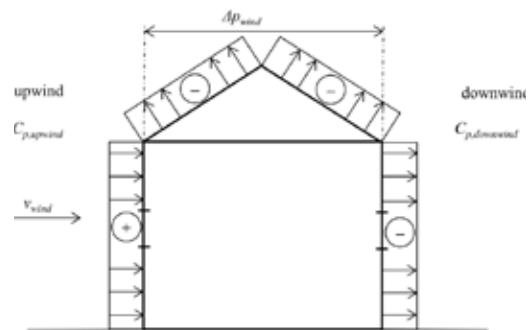

FIG. 4 Illustration of the wind pressure distribution on a building

The flow control is divided into summer operation and winter operation. During the winter operation the flow is maintained at the required minimum airflow of 2036 m³/h to keep heating costs at a minimum. This minimum value of fresh air is calculated according to EN15251:2007 for a naturally ventilated building (DIN EN 15251). During the summer operation an elevated airflow of 3330 m³/h is maintained to effect comfortable ventilation.

The building was heated in winter to maintain a room temperature of 20 °C as per DIN EN1521:2007 (DIN EN 15251). In the simulation, heating control was realized using an occupancy schedule. The heating was switched on to maintain the required temperature only during the occupied period, which is the normal working time from 6 a.m. to 6 p.m.. In summer, there was no additional cooling other than comfort ventilation by the elevated outside air volume.

3.4 INVESTIGATED ASPECTS

General Parameters

The VDI reference building was simulated under varying conditions. The flow from the solar chimney is influenced by a number of factors like solar radiation, ambient air temperature, wind profile, and inlet and outlet position. Therefore, general parameters are studied first, to understand the influence of each parameter. The optimized solar chimney is then simulated for different cities to analyze the potential for Germany with its different weather conditions, respectively. The investigated general parameters can be seen in Table 5.

VARIANT	DESCRIPTION
Effect of solar radiation	Dependence of the flow from solar chimney on the radiation and ambient temperature.
Effect of chimney inlet position	The effect of the height of the solar chimney inlet position at the floor.
Effect of wind	Effect of wind under influence of wind pressure coefficients (Cp) and wind velocity profile.
Effect of chimney outlet position	The flow rates from the solar chimney for various positions of the outlet.

TABLE 4 Investigated general parameters

The ventilation effectiveness of the solar chimney is influenced by the radiation and ambient temperature as well as by the wind effect. The influence of the wind effect depends on the wind velocity, profile, direction and the wind pressure coefficients. Figure 4 shows an illustration of the distribution of the wind pressure occurring on a building

The wind can either support or lower the natural ventilation. It creates a pressure difference between upwind and downwind façade of the building. The unsteady, pulsating and frequently changing speed and direction of the wind makes the effect difficult to predict and depends on the location of the building.

When the outlet of the solar chimney is located in a negative pressure zone, the wind effect supports the natural ventilation. If the outlet is located in a positive pressure zone instead, the wind will decrease the volume flow or even create a backflow in the chimney. Simulations were conducted for different positions of the outlet of the chimney. The average wind pressure coefficients C_p at the wall were taken from the TRNFLOW manual for a semi-shielded building ("TRNFLOW," 2009).

Potential in Germany for different locations

To analyze the potential of using solar chimneys in Germany, the simulations were done with the weather data of four German cities (Munich, Hamburg, Berlin and Stuttgart). Each city has its own microclimate due to the topography, terrain, population density and proximity to water bodies. For example, Munich, being much more of a landlocked city, has more of a humid continental climate, whereas Hamburg, being closer to the sea, has an oceanic climate. The performance of the solar chimney was analyzed in these climates for three different variants, respectively. In the first, base simulation variant, the flow through the solar chimney occurs only due to stack effect without considering wind effects. In the second simulation variant, all parameters are the same as in the base variant with wind effect enabled. In the third variant, the base variant is modified to utilize the chimney for an occupancy time of 24 hours. An overview of the three variants can be seen in Table 6.

VARIANT	OCCUPANCY TIME	WIND
City	6:00 – 18:00	Not included
City_WND	6:00 – 18:00	Included
City_24h	0:00 – 24:00	Not included

TABLE 5 Overview of simulated variations for each city

4 RESULTS

4.1 GENERAL PARAMETERS

Effect of solar radiation and ambient temperature

The most important parameter to validate the viability of solar chimneys in Germany is the operation time, in which the required air volume flow is maintained. As an example, the 24h-simulation in Munich without wind will be discussed below. The volume flow of fresh air provided for the ground floor (flow_GF_in) can be seen in Fig. 5. The volume flow is plotted together with the ambient temperature (Temp_amb) as well as the indoor temperature of the ground floor (Temp_GF). Only during the summer period, the required volume flow cannot be provided by the solar chimney for certain hours.

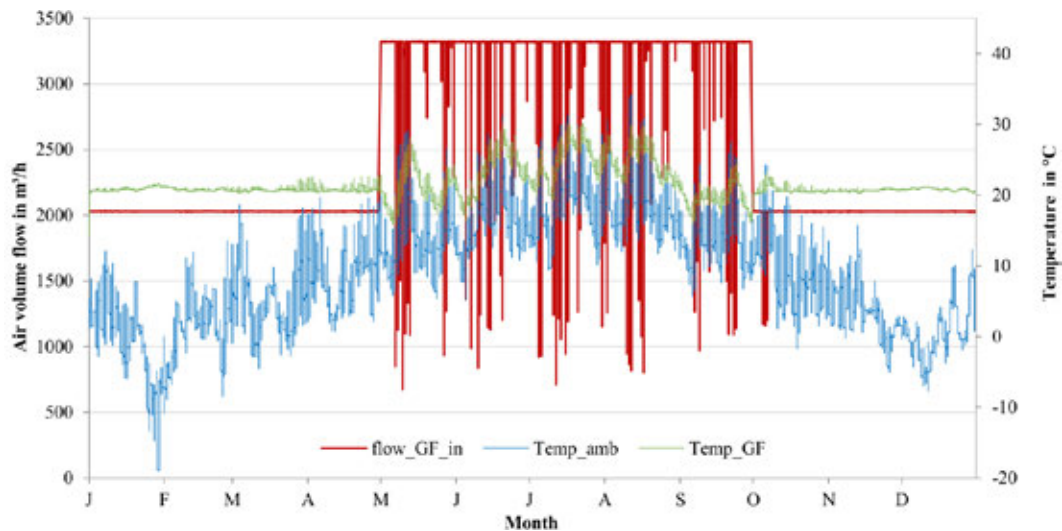

FIG. 5 Temperature changes and volume flow of fresh air for a reference year (Ground floor, Munich, 24h-simulation)

The analysis of the results showed that the flow rates in the chimney are much more dependent on the ambient temperature than on radiation. The flow through the solar chimney is driven by the temperature difference between the air in the chimney and outside air. During winter time the air temperature inside the building is always relatively high due to internal loads. However, the ambient temperature is low at the same time, so the stack effect is well maintained during the winter period. The effectiveness of ventilation using solar chimney can be limited during summer time due to high ambient temperatures. With an increased solar radiation not only the heat absorbed in the solar chimney increases but also the ambient temperature.

The temperature difference directly influences the pressure difference. The hours, in which the required air volume flow cannot be provided by the solar chimney result from a low pressure difference between the inside and the outside. If the ambient pressure is higher than the pressure in the building, a backflow will occur in the solar chimney. The resulting decrease of the volume flow and the influence of the pressure difference can be seen in Fig. 6 for a week in August from 14th of August (hour 5400) to 21st of August (hour 5592).

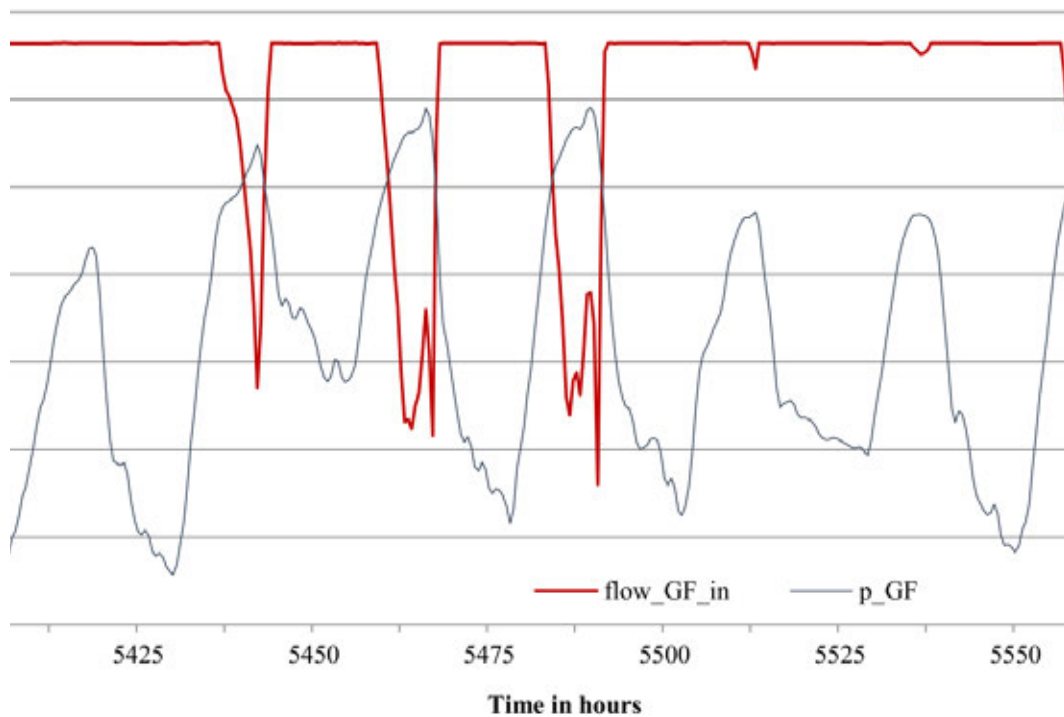

FIG. 6 Pressure Difference and volume flow of fresh air for a week in August (Ground floor, Munich, 24h-simulation)

Effect of chimney inlet position

The fluctuation of the pressure difference is a result of the temperature difference between the outdoor temperature and the temperature inside of the building and the solar chimney respectively. As part of the simulation, it was also noticed that the backflow depends on the height of the opening (window) between the solar chimney and the room, as well. The backflow was reduced to almost zero when the opening from the office space to the solar chimney was placed at the ceiling level.

Effect of wind

The wind effects are classified on the basis of wind pressure coefficients and wind velocity profiles. Both these factors depend on the location and terrain of the surrounding area. When a solar chimney is located in an open area, the wind velocity impinging the building is always higher than a location in a city due to the lack of obstructions on its path. This leads to a high wind pressure acting on the faces of the chimney aiding the flow. The wind pressure coefficients also depend on the wind velocity of a particular location. The wind speeds reduce at the surface level as we approach the city limits. The wind profile in this case is modified to have lower velocities at the bottom of the profile. This design aspect has to be kept in mind while designing solar chimneys, whereas similar sized chimneys may have different flows when placed in a city and when placed in an open area like near the sea.

The solar chimney was analyzed for pressure drops and flows in various outlet positions. The positions explored were north, south and the top. The configurations with outlets on east and west are not explored due to the small width of the chimney. The outlet positioned on the south or north side had opposing effects from incoming wind. The flow due to stack effect and the flow due to wind effects were opposing each other at certain times, and effectively reducing the flow. The outlet positioned on the top of the chimney produces highest flow rates. The top side of the chimney always lies in an area of negative suction due to wind and is independent of the wind direction. The magnitude of the suction pressure is only dependent on the wind velocity and therefore produces the highest average flows on a yearly basis.

4.2 POTENTIAL IN GERMANY FOR DIFFERENT LOCATIONS

The percentages of the time, in which the required volume flow of fresh air can be provided, differ depending on the simulated variation. The results of the three selected variations can be seen in Table 6 for all four locations.

Based on the results of the simulations it can be concluded that solar chimneys have a great potential to be used in Germany, as they provide the required volume of airflow most of the time (always more than 97%), other than small periods, where it is below the required limit. When the building is in permanent use (24h a day) the ventilation can be provided by the solar chimney for approximately the same and sometimes even a higher percentage of time, because of the higher temperature differences during the night. The effect of wind can support the effectiveness of the solar chimney and extend the operation hours for all locations. The percentage of time, in which the required ventilation is provided, is higher at Berlin and Hamburg compared to Stuttgart and Munich for the simulations considering wind effects.

VARIATION	FLOOR	MUNICH	HAMBURG	BERLIN	STUTTGART
City	0	97.3 %	98.4 %	98.2 %	98.1 %
	1	98.7 %	98.9 %	99.1 %	98.4 %
	2	98.4 %	98.7 %	99.1 %	98.2 %
City_WND	0	98.0 %	99.3 %	99.1 %	98.9 %
	1	99.2 %	99.7 %	99.8 %	99.4 %
	2	99.2 %	99.7 %	99.9 %	99.4 %
City_24h	0	97.8 %	98.8 %	98.6 %	98.3 %
	1	98.6 %	99.1 %	99.2 %	98.5 %
	2	98.4 %	98.8 %	99.0 %	98.2 %

TABLE 6 Percentage of time, in which required ventilation is provided

5 CONCLUSIONS

In the paper the potential of using a solar chimney to provide the required amount of fresh air as per DIN EN15251:2007 has been studied using a reference building from VDI6009. Occupancy profiles of a normal office and a 24-hour office were used. The position of the outlet of the solar chimney was varied to investigate the wind effect. The cities of Munich, Hamburg, Berlin and Stuttgart were simulated and the potential for using solar chimneys were explored for their different climates. The study reveals that solar chimneys can be used to cover the fresh air demand all throughout the year for the investigated German cities (Munich, Hamburg, Berlin, Stuttgart), disregarding only a small period of time. Without the usage of conventional energy the solar chimney provides a promising technology for ventilation. Fresh air can be provided for more than 97% of the time for all four locations and for any occupancy time. Backflow and lower volume flows can occur during the summer period due to the high ambient temperatures.

The investigations showed the strong influence of the wind on the solar chimney. The design and positioning of the outlet of the solar chimney has to be adjusted to the local wind conditions. To be able to use the wind effect more efficiently, further research has to be done in this field. An optimized design of the chimney outlet could help to increase the positive effect of the wind.

The integration of a heat circuit system and storage mass to the absorber could be another opportunity to increase the effectiveness of the solar chimney. This could allow using the solar chimney concept during the whole year without the need of a mechanical backup system. This concept will be studied in following investigations.

References

- Deutscher Wetterdienst. (2010). Test Reference Year.
- DIN EN 15251 (2012). Berlin: Deutsches Institut für Normen.
- ENOB. (2016). *EnBau: "Energy-optimised new buildings" model projects*. Retrieved from <http://www.enob.info/en/research-areas/enbau/>
- IPCC. (2013). *Climate Change 2013: Fifth Assessment Report*. Retrieved from Intergovernmental Panel on Climate Change, Cambridge University Press website: <https://www.ipcc.ch/report/ar5/wg1/>
- Khanal, R., & Lei, C. (2011). "Solar chimney—A passive strategy for natural ventilation." from *Energy and Buildings*, 43(8), 1811–1819. doi:10.1016/j.enbuild.2011.03.035
- Lal, S., Kaushik, S. C., & Bhargav, P. K. (2013). *Solar chimney: A sustainable approach for ventilation and building space conditioning*. (2009). TRNFLOW.
- UNEP-SBCI. (2016). United Nations Environment Program for Sustainable Buildings and Climate Initiative - Background. Retrieved from <http://www.unep.org/sbci/AboutSBCI/Background.asp>
- VDI 6009 - Blatt 1 (2001).

Hybridization of solar thermal systems into architectural envelopes

Beñat Arregi¹, Roberto Garay², Peru Elguezabal³

- 1 Tecnalia, Parque Tecnológico de Bizkaia, Edificio 700, E-48160 Derio (Spain), +34 610742971, benat.arregui@tecnalia.com
- 2 Tecnalia, Parque Tecnológico de Bizkaia, Edificio 700, E-48160 Derio (Spain), +34 667178958, roberto.garay@tecnalia.com
- 3 Tecnalia, Parque Tecnológico de Bizkaia, Edificio 700, E-48160 Derio (Spain), +34 667178897, peru.elguezabal@tecnalia.com

Abstract

Despite significant development in the performance and efficiency of solar thermal technology, little consideration has been given to its interaction within building envelopes, aside from mechanical fixing systems. The lack of solutions for the architectural integration of solar collectors and the complexity of their assembly process remain important barriers for the widespread adoption of this technology. An innovative approach is proposed in which solar collectors are not merely integrated into conventional building envelopes, but instead these envelopes are hybridized and activated to house solar thermal systems. This poses the challenge of adapting solar thermal technology to the capacities and limitations of architectural skins. The paper presents results from three ongoing projects. BATISOL and BASSE investigate the development of solar thermal technology so as to fulfil the functional, constructional and formal requirements of building skins. Façade assemblies are turned into active skins by integrating unglazed solar collectors in the place of conventional renders and claddings. RETROKIT explores the usage of renewable energy gains within an alternative environmental control strategy, by direct supply of heated air into the ventilation system. Finally, a discussion is presented on architectural, constructional and thermal performance aspects of these solutions, based on both design assessments and experimental data.

Keywords

active skin, integrated solar, hybridized solar, unglazed solar collector

1 INTRODUCTION

Boosted by energy procurement policies, the pursuit for lower energy costs, and the ultimate need to reduce primary energy consumption, building skins are experiencing an extraordinary development in recent years, incorporating a number of energy-related technologies with increased levels of efficiency. Beyond passive measures based on insulation and thermal mass, the most advanced envelope solutions integrate a range of active renewable technologies, combined with heating, ventilation and air conditioning (HVAC) devices and even information and communication technology (ICT) systems.

Solar energy in particular can provide a key input to the energy balance of the building, and technologies such as solar thermal and photovoltaic are experiencing a rapid development. However, solar modules are typically designed as autonomous technical elements, and often conflict with other elements of the building (envelope, structure, systems, etc.). Moreover, when these innovative solutions are engineered from a purely performance-based approach, they often conflict with the architectural expression of the building.

The lack of products and solutions for the architectural integration of solar collectors within façades, together with their complex assembly process and high investment costs, constitute barriers to the widespread use of solar thermal technology in building skins.

An innovative approach is currently in development, where solar modules are conceived and developed as construction components that fulfil all functional, constructional and formal requirements of building skins. This paper discusses results from ongoing research projects exploring strategies to integrate and/or hybridize solar thermal technology into building envelopes.

2 SOLAR THERMAL TECHNOLOGY

The satisfactory performance of a solar thermal system requires notable design efforts, extending beyond its energy harvesting surfaces and the performance levels of related HVAC devices. The delivery of energy-efficient solar systems is mostly bound to the design of a complete system that meets the needs of its users, profiting of an energy source of fluctuating nature, through a carefully planned storage and delivery system.

Solar systems are faced with intermittent energy availability (solar radiation, ambient temperature) and discontinuous energy needs (building occupation, domestic hot water needs, changes in heating temperature set point). This imposes the need for thermal storage in order to compensate for the seasonal discrepancy between supply and demand. Several experiences from the field demonstrate that combined solar systems, if properly sized, can provide a relevant increase in overall system efficiency. In (Cost-Effective, 2012) experience from simulation resulted in a coefficient of performance (COP) 30–40% higher than for regular air-source heat pumps. Within the 2Sol system, developed at ETH Zurich (Leibundgut, 2013), low-temperature input from photovoltaic/thermal collectors was used to regenerate a seasonal ground heat storage, reaching a COP above 8 in new buildings, and above 6 in retrofit (Haller, Sandoval, Nogueira, Ruggie, & Leibundgut, 2014).

In principle, solar thermal systems are able to absorb, transfer and store solar energy. Solar collectors are responsible for the first of these functions, while the absorbed heat is usually transferred through a fluid. For a given solar radiation level and ambient temperature (which are ultimately determined by local weather and climate), performance levels are fundamentally driven by the average temperature of the fluid. Therefore, the efficiency of solar thermal collectors can be broadly defined according to their type:

- Vacuum tube collectors suit high temperature applications such as solar cooling systems. In this technology, the absorber is suspended in vacuum and contained within glass tubes. The arrays of glass cylinders need to be placed within the building envelope. The most successful integration strategies incorporate the glass tubes into the design, for instance as parapets or screens for balconies (Fig. 3a).
- Glazed flat plate collectors constitute the most common technology. The absorber plate sits between a glass cover above (to allow solar radiation in) and an insulating layer behind (to minimise heat loss). A number of integration solutions for flat plate collectors are available in the market, commonly linked to specific cladding systems or lightweight façades (Fig. 3b).
- Unglazed collectors are the simplest technology of solar thermal collector, consisting only on an absorber that can be metallic (Fig. 3c) or polymer-based. Unglazed collectors are only sufficiently performing for applications that deliver fluid at lower temperatures. Currently, they are typically used for swimming pool heating systems, low temperature space heating or pre-heating of domestic hot water.

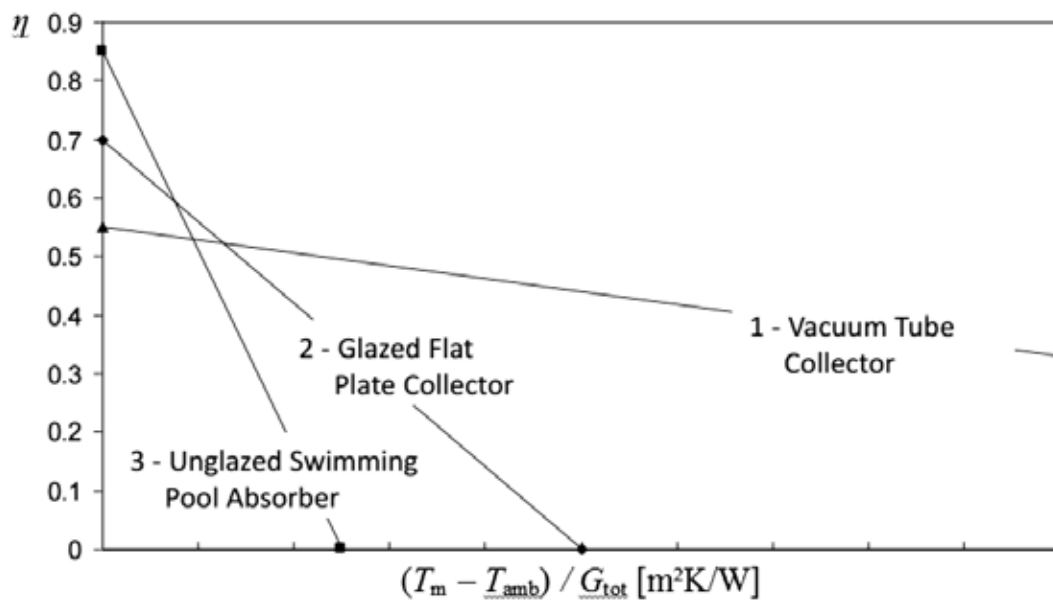

FIG. 1 Efficiency (η) of solar collectors depending on fluid-to-ambient temperature differential ($T_m - T_{amb}$) divided by incident solar radiation (G_{tot}). Source: (Giovanardi, 2012); see also (Duffie & Beckmann, 2013)

The efficiency of thermal systems is mostly related to the temperature at which heat is delivered. For solar systems, a lower output temperature results in a higher energy output for the same solar input. However, reduced service temperatures require larger surfaces in order to exchange the same amount of heat with the occupied space of buildings. Under this principle, low-exergy systems target low-temperature delivery systems such as radiant floors (Fig. 2). Other types of heat uses such as pool heating and domestic hot water heating are serviced at temperatures close to their set service temperatures. For the case of solar cooling systems, temperatures above 100 °C are recommended for thermally driven chiller systems.

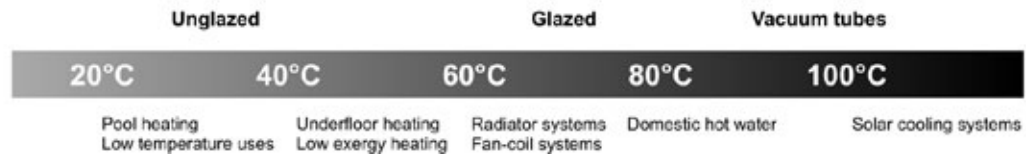

FIG. 2 Temperature levels of solar collector technologies, compared to HVAC services in buildings

Despite their limitations, unglazed collectors constitute a promising solution for the widespread integration of solar systems in building envelopes. Their relatively low fluid temperature (Fig. 2) imposes the use of heat pumps, storage tanks and/or other auxiliary devices in order to ensure that delivered fluid temperatures suit the needs of building systems such as space heating or domestic hot water.

3 ARCHITECTURAL IMPACT OF SOLAR TECHNOLOGY IN BUILDING SKINS

The interaction of solar thermal systems into architectural projects faces not only technological barriers in the field of HVAC systems, or related to the aesthetics of the system itself, but also those related with the adaptation of the architectural solution to each specific building project. The implementation of solar systems requires a large envelope surface, resulting in a noticeable impact in the architectural expression of the building.

The authors propose the following overarching classification describing architectural strategies for the interaction of solar thermal systems with building envelopes:

- Addition: No consideration is given to the impact of thermal systems on the architectural quality of the building. Solar collectors are engineered as standalone elements and mechanically assembled over the building envelope. The system does not include a solution for its connection to the elements and systems of the building.
- Integration: Solar thermal systems are integrated within modular structures such as cladding systems or curtain walls, allowing for some dimensional flexibility in order to match the grid and composition of the façade. Collectors are usually glazed, and designed to conceal pipework and connections.
- Hybridization: Façade assemblies are hybridized with active thermal systems, by incorporating unglazed solar collectors within external renders and claddings. A neutral aesthetic impact is achieved, where users cannot differentiate between hybridized and ordinary building skins. These solutions are commonly combined with advanced HVAC systems, in which solar systems are connected with thermal storage, heat pumps, and/or low energy delivery systems such as radiant floors or thermal mass activation.

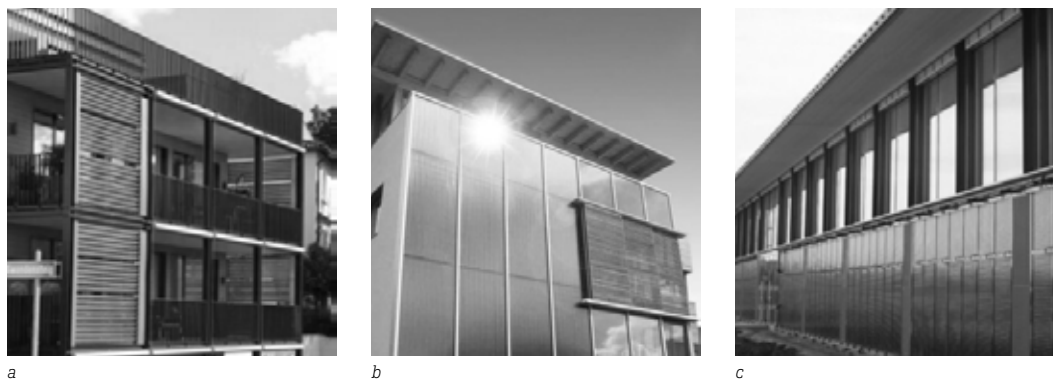

FIG. 3 Façade integration solutions for a) vacuum tube collectors (Schweizer Energie), b) flat plate collectors (Winkler Solarfassade), c) unglazed collectors (Energie Solaire, Toiture Solaire AS)

Despite the availability of an increased number of solutions for the architectural integration of solar systems (Fig. 3), these are still not widespread in the solar collector market. Most solutions result in a technification of the appearance of the façade, as only glazed or metal finishes are available. An extensive research on the architectural integration of solar systems in façades was carried out in (International Energy Agency, 2012).

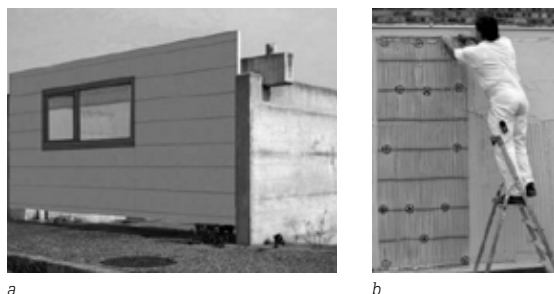

FIG. 4 a) Capillary tubes within steel cladding system (SOLABS, 2006), b) render finish (Cost-Effective, 2012)

A number of research projects have focused on the development of hybridized solutions towards the activation of building envelopes without modifying their external appearance. Within (SOLABS, 2006) a steel façade cladding system was adapted for the integration of water-based capillary tubes on its internal side. Within (Cost-Effective, 2012) a façade system was developed based on external thermal insulation systems, in which capillary tubes were integrated within the external render finish, coupling the system with a heat pump for decentralized space heating.

4 CASE STUDIES

Tecnalia has contributed to the conceptualization, design and testing of three innovative solar thermal solutions presented below. For their optimisation and validation in real usage conditions, experimental campaigns have been carried out at the KUBIK test facility (Garay, et al., 2015). KUBIK is located at Tecnalia's premises in the Basque Country, close to the northern coastline of Spain (43°17'N 2°52'W), in a warm temperate climate representative of Central and Western Europe, corresponding to Cfb within the Köppen-Geiger classification (Kottek, Grieser, Beck, Rudolf, & Rubel, 2006).



FIG. 5 Pilot set-ups at south-facing façade of KUBIK test facility: (a) integrated solar air collector (RETROKIT, 2016), (b) hybridized sandwich-type steel envelope (BASSE, 2016)

4.1 GLAZED AIR SOLAR COLLECTOR FOR INTEGRATION IN ENERGY RETROFIT

The design of the glazed air solar collector developed within (RETROKIT, 2016) has been based on a technological framework consisting of an extruded aluminium frame and a rotating louvre system for the control of ventilation flows in the collector (Amundarain, et al., 2014). The collector is directly anchored into the existing façade, and integrates within an external render system for energy retrofit of existing buildings. The absorber is composed by a single aluminium sheet painted in black (Fig. 5a). The system can adapt its dimensions for adapting to particular project needs, following design criteria for curtain wall systems.

The system does not focus on a direct use of the collected energy; instead it integrates into a wider HVAC system, by directing outlet ducts to manifolds in the upper area of the façade. Several modules can be accommodated, in order to increase mass flow or output temperature as required by the HVAC system of the building.

An experimental campaign was carried out at the KUBIK test facility from January to June 2015. The test proved the capacity of the system to raise ventilation air temperature in sunny days within the heating season (Fig. 6), potentially allowing for a substantial reduction of heating loads in buildings.

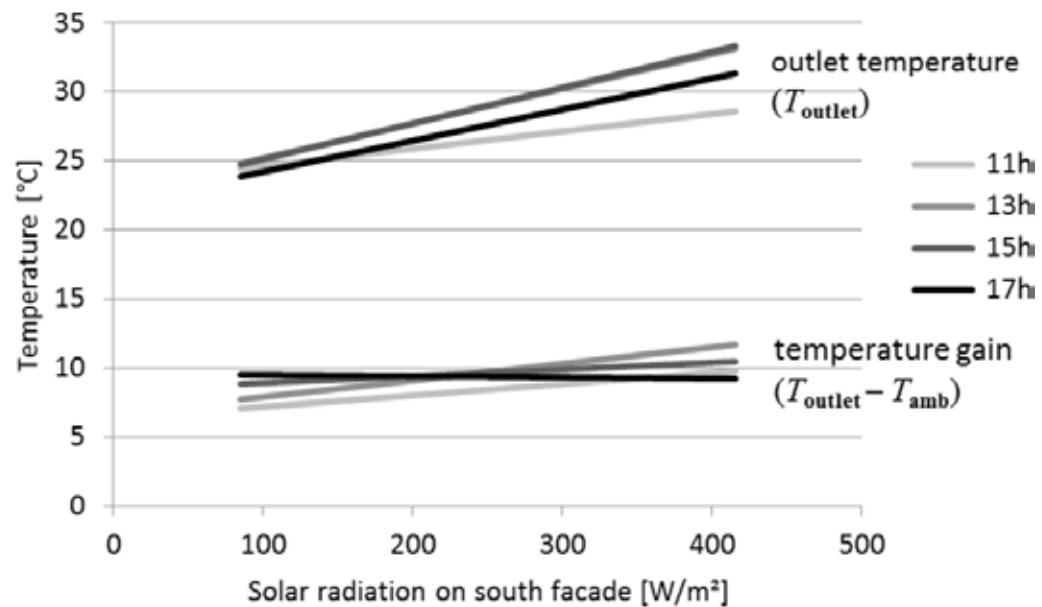

FIG. 6 Results from experimental tests of (RETROKIT, 2016) at KUBIK test facility during March-May 2015: service temperature levels of solar collector (T_{outlet}) and temperature gain from ambient air ($T_{outlet} - T_{amb}$) as a function of incident solar radiation, for different times of day (11h, 13h, 15h, 17h)

4.2 UNGLAZED SOLAR COLLECTOR HYBRIDIZED INTO STEEL-BASED SANDWICH PANELS

Sandwich envelope systems offer a fast installation within limited cost. Although they were originally associated with industrial buildings, newly developed solutions with a metal finish are increasingly common in commercial and multi-rise residential buildings. Ventilated façades, widely adopted in the EU as a retrofit solution, commonly consist of a metal substructure and a cladding material that can be metal, stone, ceramic or phenolic, among others.

A number of projects such as (SOLABS, 2006) have investigated the integration of fluid loops within highly conductive cladding materials as the absorber of an unglazed collector. An innovative solution is developed within (BASSE, 2016) in which steel sandwich panels are used to integrate the pipework for an unglazed collector, using an additional external steel layer with a selective coating that maximizes the absorption properties (Fig. 5b).

One of the most remarkable advantages of this technology lies in its seamless integration between building envelope and solar thermal collector field. The observer cannot notice any difference between active and non-active sections of the building envelope.

Initial surface temperature measurements at the external skin (without fluid circulation) carried out at the KUBIK test facility demonstrated that values up to 72 $^{\circ}C$ can be achieved in a November hot day with maximums of 22 $^{\circ}C$ ambient temperature and 850 W/m^2 irradiance (Fig. 7 left). Once the fluid circulates through the collector, the temperature of the skin becomes lower thanks to the refrigeration action of this fluid. This continuously captured energy is deployed into a buffer tank. Fig. 7 right shows a representative day of June, with maximums of 25,3 $^{\circ}C$ ambient temperature and 435 W/m^2 irradiance. A maximum skin temperature of 46,9 $^{\circ}C$ is reached, with a thermal increase of 21,1 $^{\circ}C$ in the storage, heating up this thermal buffer up to 36,3 $^{\circ}C$ over 5,23 hours.

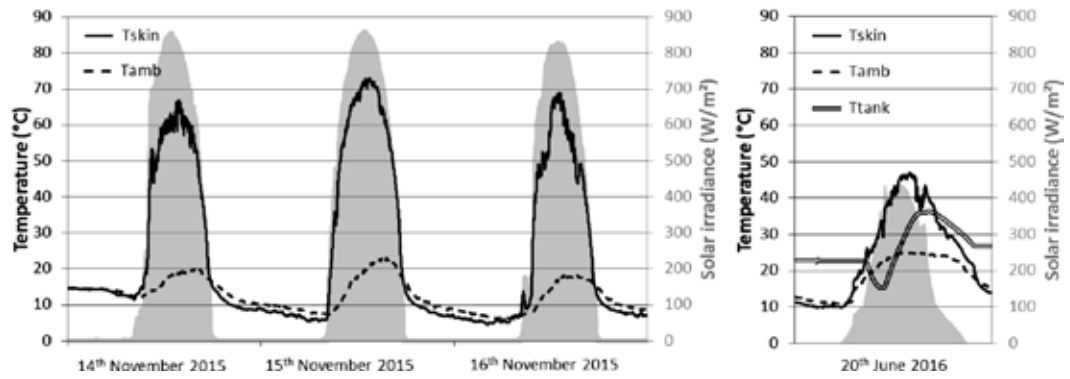

FIG. 7 Temperatures of ambient air (T_{amb}), skin (T_{skin}) and tank (T_{tank}) and solar irradiance (gray shaded area) for selected days measured during experimental test of (BASSE, 2016) at KUBIK test facility

The output temperature provided by the system is below service levels required for space heating and domestic hot water. This implies the use of a heat pump where the collector field is connected to its source. Once the sizing of the source-side storage is carried out correctly, the proposed layout provides a stable high temperature source for the heat pump, with a substantial increase of its performance when compared with benchmark heat pump technologies. Numerical and experimental technical assessments have demonstrated that this technological approach reaches the performance level of benchmark unglazed solar collectors.

4.3 UNGLAZED SOLAR COLLECTOR FOR HYBRIDIZATION INTO LIGHTWEIGHT FAÇADE SYSTEMS

Within the BATISOL project, a low-cost unglazed solar technology has been developed for seamless integration behind lightweight metal cladding systems. The collectors are modular and the design has been focused on optimising their assembly process. The integration with combined solar systems and heat pumps will provide thermal energy for heating and hot water through the use of a highly efficient technology.

Initially, a parametric study was carried out using finite element analysis within COMSOL Multiphysics software (Bonnamy, Raji, Lopez, & Garay, 2016), in order to establish an optimum geometry for the collector from a performance point of view. Results showed that the most influencing parameters determining the overall efficiency are (1) the width/depth ratio of the collector channels and (2) the spacing between these channels.

Results from simulation (Fig. 9) show good agreement with measurements from a test bench prototype. A full scale experimental test will be carried out in Bordeaux during 2017.

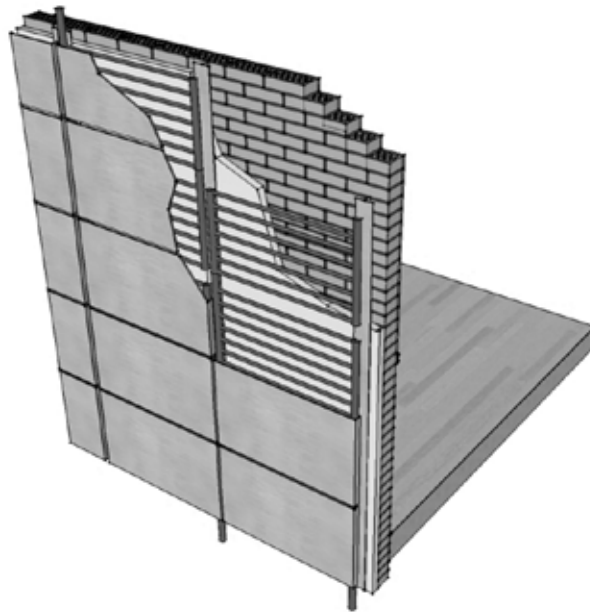

FIG. 8 Concept sketch of the solution developed within the BATISOL project

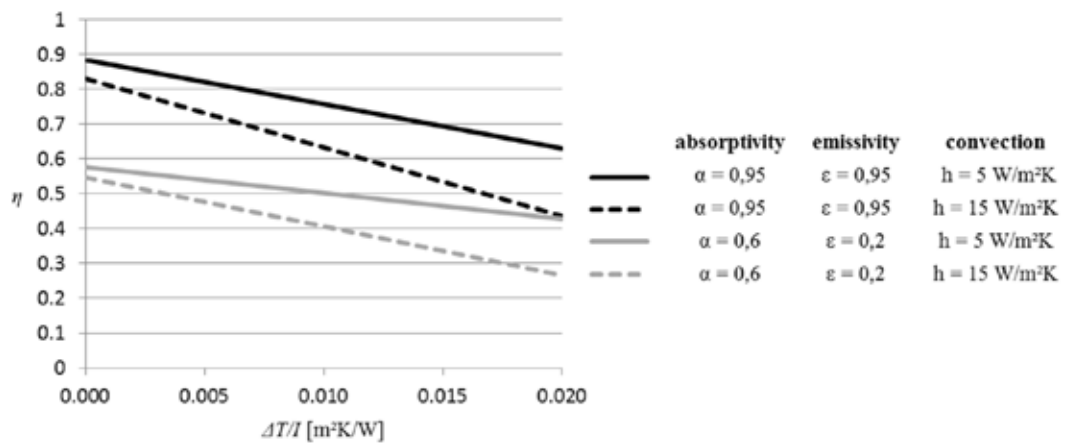

FIG. 9 Simulated performance of BATISOL solution as a function of temperature differential divided by solar irradiance (Bonnamy, Raji, Lopez, & Garay, 2016). The four scenarios combine an external surface of galvanised steel ($\alpha = 0,6$; $\epsilon = 0,2$) or matt black coating ($\alpha = 0,95$; $\epsilon = 0,95$) with low ($h = 5 \text{ W/m}^2\text{K}$) or moderate ($h = 15 \text{ W/m}^2\text{K}$) wind conditions

5 DISCUSSION

Although still under development and in early deployment scale, the field of integrated and hybridized solar thermal technologies is promising. Their underlying approach reaches far beyond the adaptation of solar thermal collectors to sizes and dimensions to match façade grids, leading into full envelope systems designed to absorb solar energy.

Three innovative technological solutions have been presented for the inclusion of solar renewable technology within building skins, each based on a different exploratory approach. The placement of solar collectors within the façade foregoes an optimum orientation/tilt in order to achieve an integrated solution that is better suited to the architectural requirements of façade design.

Glazed air collectors are a suitable solution for centralized or decentralized ventilation systems and can be integrated as part of retrofitting systems and kits. On the other hand, the hybridization of main building envelope systems (renders, steel-based cladding solutions and sandwich panels) allows for an efficient incorporation of unglazed collectors into combined solar systems. Experimental results are within a performance range that corresponds to the potential of the solar technologies developed within these projects, making use of renewable sources to achieve a substantial improvement in energy efficiency. Even if the assessed systems are still in development stage, it is expected that their lower complexity when compared to current market solutions should result in a reduction of investment, operation and maintenance costs.

In the following years, these technologies should develop into industrially and economically viable solutions with certified performance levels and relevant certifications, achieving full integration and hybridization into building skins.

Acknowledgements

The research leading to the results reported in this work has received funding from the European Union Seventh Framework Programme FP7/2007–2013 project RETROKIT (Grant Agreement No 314229), Research Fund for Coal and Steel project BASSE (Grant Agreement No RFSR-CT-2013-00026) and INEF4 (Institut pour la Transition Énergétique) project BATISOL.

References

- Cost-Effective. (2012). Prototype for solar assisted decentralized heat pump (WP3). Retrieved from <http://www.cost-effective-renewables.eu/>
- Leibundgut, H. (2013). ZE-2Sol. Retrieved from ETH Zurich: <http://dx.doi.org/10.3929/ethz-a-010041361>
- Haller, N., Sandoval, D., Nogueira, J., Ruggie, J., & Leibundgut, H. (2014). Hybrid Roofscape – Development and experimental results of roof-integrated PV/T-collectors for ZeroEmission-LowEx building systems. WSB14 Barcelona Conference Proceedings, vol. 4, pp. 76-82.
- Giovanardi, A. (2012). Integrated solar thermal facade component for building energy retrofit (Doctoral thesis). Università Degli Studi di Trento.
- Duffie, J., & Beckmann, W. (2013). Solar Engineering of Thermal Processes, 4th Ed. Hoboken, NJ, USA: John Wiley & Sons.
- International Energy Agency. (2012). Task 41: Solar Energy and Architecture. Retrieved from <http://task41.iea-shc.org/>
- SOLABS. (2006). Development of unglazed solar absorbers (resorting to coloured selective coatings on steel) for building façades, and integration into heating system. Retrieved from <http://leso.epfl.ch/page-37325-en.html>
- Garay, R., Chica, J., Apraiz, I., Campos, J., Tellado, B., Uriarte, A., & Sanchez, V. (2015). Energy efficiency achievements in 5 years through experimental research in KUBIK. Energy Procedia, 6th International Building Physics Conference, IBPC 2015, vol. 78, pp. 865–870.
- Kottek, M., Grieser, J., Beck, C., Rudolf, B., & Rubel, F. (2006). World Map of the Köppen-Geiger climate classification updated. Meteorologische Zeitschrift, vol. 15, pp. 259-263.
- RETROKIT. (2016). Toolboxes for systemic retrofitting. Retrieved from <http://www.retrokitproject.eu/>
- BASSE. (2016). Building Active Steel Project. Retrieved from <http://www.basse-eu.com/>
- Amundarain, A., Campos, J., Chica, J., Meno, S., Uriarte, A., Garay, R., ... Apraiz, I. (2014). Patent No. EP 2520870 B1: Passive solar collector module for building envelope.
- Bonnamy, P., Raji, S., Lopez, J., & Garay, R. (2016). Expérimentation et modélisation d'un capteur solaire opaque pour préchauffage de l'eau. Congrès Français de Thermique 2016. Toulouse.

Solar façades – Main barriers for widespread façade integration of solar technologies*

Alejandro Prieto¹, Ulrich Knaack², Thomas Auer³, Tillmann Klein⁴

- 1 Delft University of Technology, Faculty of Architecture and the Built Environment, Department of Architectural Engineering + Technology, Façade Research Group. Julianalaan 134 2628BL Delft, Netherlands. +31 6 48462317. A.I.PrietoHoces@tudelft.nl
- 2 Delft University of Technology, Faculty of Architecture and the Built Environment, Department of Architectural Engineering + Technology, Façade Research Group. Julianalaan 134 2628BL Delft, Netherlands. U.Knaack@tudelft.nl
- 3 Technical University of Munich, Department of Architecture, Chair of Building Technology and Climate Responsive Design, Arcisstraße 21 80333 Munich, Germany. Thomas.Auer@tum.de
- 4 Delft University of Technology, Faculty of Architecture and the Built Environment, Department of Architectural Engineering + Technology, Façade Research Group. Julianalaan 134 2628BL Delft, Netherlands. T.Klein@tudelft.nl

Abstract

Solar energy has been actively promoted as a clean energy source since 1973's oil crisis, evidenced by the emergence of initiatives such as the Solar Heating & Cooling Programme of the International Energy Agency or the US Department of Energy. Nonetheless, solar technologies have not been widely used in the built environment, limiting their operation to industrial and macroscale applications. Commercially available products such as building integrated PV panels (BIPV) or building integrated solar thermal collectors (BIST); and novel prototypes and concepts for solar cooling integrated facades are seen as interesting alternatives for the development of new performance based façade components for high-performing commercial buildings. However, there are barriers to overcome in order to promote widespread application of architecturally integrated solar components.

The present paper seeks to discuss perceived barriers for widespread façade integration of solar technologies, in order to define the current scenario and generate guidelines for future developments. In order to achieve this, the paper presents the results of a survey addressed to professionals with practical experience in the development of façade systems for office buildings, situated at any stage of the design and construction process. Hence, architects, façade consultants, system suppliers and façade builders were considered. The outcome of this study is the definition of the main perceived barriers for façade integration of solar technologies, discussing the results from the survey along with other related experiences found in the literature.

This study is part of the ongoing PhD research project titled COOLFACADE: Architectural integration of solar cooling strategies into the curtain-wall, developed within the Façade Research Group (FRG) in the Green Building Innovation programme (GBI) of the Faculty of Architecture and the Built Environment, TU Delft.

Keywords

Solar technologies, PV, Solar thermal collectors, Solar cooling, Façade integration, Survey

- * Full paper published in JFDE / Journal of Façade Design and Engineering, Volume 5, Number 1, 2017.
DOI 10.7480/jfde.2017.1.1398

Solar PV Building Skins – Structural Requirements and Environmental Benefits*

Claudia Hemmerle¹

¹ Center for Sustainable Building, Technical University of Munich, Arcisstr. 21, 80333 Munich, Germany, tel. +49.89.289.23990, fax +49.89.289.23991, claudia.hemmerle@tum.de

Abstract

Solar electricity produced by photovoltaic (PV) systems will play a major role in future energy supply systems. Integrating PV modules into buildings' envelopes can stimulate new architectural applications and improve sustainability of both PV power generation and buildings. The majority of the photovoltaic (PV) modules used in building skins contains glass, but does not entirely comply with the product standards and design rules for glass in building. Their mechanical performance as glazing product has not been adequately characterized. As a result, structural applications are subject to individual approval by the building authorities in many cases. This paper presents experimental research on glass based photovoltaic modules, analysing their mechanical properties in comparison with approved construction products. The focus is on glass-glass modules and on the question whether the most common module configurations can be classified as laminated safety glass. Testing included residual resistance testing to study the potential to provide residual load-bearing capacity and shear testing to examine the interaction of photovoltaic cells and interlayer material as well as adhesion characteristics. If approved interlayers are used, glass-glass PV modules correspond to the safety level of laminated safety glass, because the integration of crystalline silicon cells or thin-film solar cells does not impair breakage behaviour and improves residual resistance, while the observed reduced adhesive bond does not imply a higher injury risk. Formal classification of photovoltaic products within the product and design standards for glass in building could facilitate the use of building-integrated photovoltaics.

Left: Structural application of PV modules as roof glazing. © Bruno Klomfar.

Above: Common types of glass-glass PV modules.

Life-cycle assessments of photovoltaic systems so far concentrated on roof-top and ground-mounted installations. Based on these studies, the specific environmental performance of building-integrated systems was analysed. Constructive integration of the PV modules associated with the substitution of conventional materials in the building skin reduce the life-cycle environmental impacts like primary energy demand and greenhouse gas emissions, especially in those areas with suboptimal solar irradiation like façades. The net energy payback times calculated for Central European range from 0.8 and 5.6 years and the net carbon footprint varies between 12 and 192 g CO₂-eq/kWh.

Keywords

Photovoltaics, glazing, laminated safety glass, approval, energy payback time, carbon footprint

* Full paper published in JFDE / Journal of Façade Design and Engineering, Volume 5, Number 1, 2017.
DOI 10.7480/jfde.2017.1.1528

Infra-Lightweight Concrete – A monolithic building skin

Mike Schlaich¹, Alex Hückler², Claudia Lösch³

- 1 Technische Universität Berlin, Chair of Conceptual and Structural Design, Gustav-Meyer-Allee 25, 13355 Berlin, Germany, Tel.: +49 (0)30 314-72130, Fax: +49 (0)30 314-72132, ek-massivbau@tu-berlin.de
- 2 Technische Universität Berlin, Chair of Conceptual and Structural Design, Gustav-Meyer-Allee 25, 13355 Berlin, Germany, Tel.: +49 (0)30 314-72139, Fax: +49 (0)30 314-72132, alex.hueckler@tu-berlin.de
- 3 Technische Universität Berlin, Chair of Conceptual and Structural Design, Gustav-Meyer-Allee 25, 13355 Berlin, Germany, Tel.: +49 (0)30 314-72139, Fax: +49 (0)30 314-72132, claudia.loesch@tu-berlin.de

Abstract

The advantages of insulating concrete as the outer skin of a building are manifold: monolithic walls with simple and thus robust structural details enable sustainable constructions with low maintenance demands and high architectural potential. However, strict energy saving regulations push insulating concretes more and more to their limits.

Infra-Lightweight Concrete (ILC) is a High Performance Lightweight Aggregate Concrete (HPLWAC) with a dry density between 600 and 800 kg/m³. It was developed at TU Berlin and stands out from other insulating concretes due to an exceptional combination of low thermal conductivity and comparatively high strength. It is therefore a real alternative to the currently dominating thermal insulation composite systems.

The TU Berlin investigates the potential of ILC from various perspectives. A currently finalized research project focussed on the application of ILC in multi-story residential buildings. During a DFG-funded project, the bending behaviour of ILC including bonding and deformation was researched and a design method proposed. Currently, a multidisciplinary team aims at developing multifunctional ILC-members which combine material properties, varying within the cross section, with additional functions such as active wall insulation or photocatalytic air purification during a three-year research project. This paper summarizes the main aspects of the various research activities to describe the current state of development.

Keywords

Monolithic Building Skin, Infra-Lightweight Concrete, Insulating Concrete, Robust, Load-Bearing Insulation

1 INTRODUCTION

Infra-Lightweight Concrete (ILC) was developed at the Chair of Conceptual and Structural Design at the Berlin University of Technology (TU Berlin). Research on the topic has been carried out for more than ten years. ILC is an insulating concrete with a dry density of 800 kg/m³ and below, which is achieved by using the lightweight aggregate expanded clay and several admixtures (Hückler und Schlaich). ILC stands out from other insulating concretes due to an unusual combination of low thermal conductivity and comparatively high compressive strength.



FIG. 1 Single family home with outer ILC walls in Berlin, 2007 (Photo: M. Schlaich)

The first building with ILC outer walls, a single-family home in Berlin, was constructed in 2007 (Schlaich und Zareef 2008). Subsequent research led to major improvements of the concrete mix (Schlaich und Hückler 2012). Today a range of mixtures with dry densities from 600 to 800 kg/m³ is available which provides a variety of combinations of thermal conductivity and strength (Table 1).

PROPERTY	ILC800	ILC750	ILC700	ILC650	ILC600
Mean compression strength $f_{\text{ilcm,cyl}}$ (in N/mm ²)	12,96	11,26	9,41	7,35	5,30
Flexural tensile strength f_{ilctm} (in N/mm ²)	0,87	0,82	0,76	0,71	0,65
Modulus of elasticity E_c (in N/mm ²)	3900	3500	3100	2700	2300
Thermal conductivity $\lambda_{\text{tr},10}$ (in W/(mK))	0,193	0,178	0,166	0,153	0,141

TABLE 1 Properties of the Infra-Lightweight Concrete family (Hückler 2016)

The advantages of insulating concrete are obvious. The monolithic building envelope implies no necessity for insulating panels, simpler structural details and construction processes while allowing a high visual design potential due to fair faced surfaces. Therefore, the general interest and hence the research activities in this field are noteworthy (see e.g. Breit et al. 2014; Brouwers et al. 2015; Thienel 2015). A variety of insulating concrete products is currently available on the market. However, increasing energy saving regulations, such as the German Energy Saving Ordinance (BMVBS 2014), push most insulating concrete mixtures to their limits. The reduction of thermal conductivity that is necessary to meet the requirements without pushing the outer wall thickness to extremes usually comes at the costs of reduced strength and therefore a limited range of application – reducing possible building heights and hence number of stories. This is where Infra-Lightweight Concrete shows its advantageous characteristics. Compared to other products on the German market, ILC possesses a relatively high ratio of strength over density (Lösch et al.). This allows architects and engineers to envisage the construction of ILC multi-story buildings with 6 to 7 stories and above, depending on layout, design etc.

The potential of ILC was first demonstrated by the Smart Material House (Fig. 2). This project was designed by Barkow Leibinger Architekten, schlaich bergemann und partner, and Transsolar Energietechnik in 2011. The basic idea is the combination of ILC precast elements with continuous wooden slabs. The design was awarded the 2nd Prize of the Global Holcim Award in 2012 (Schlaich und Hückler 2012).

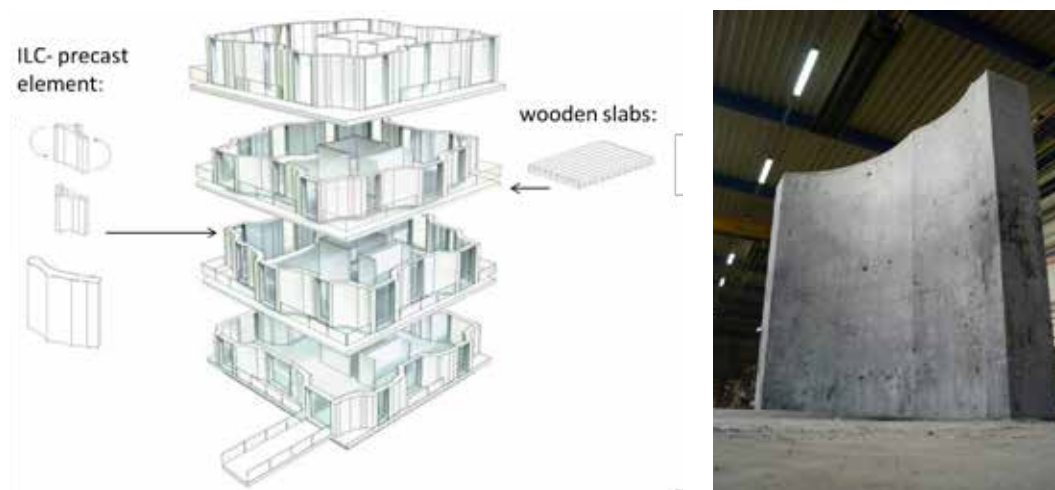

FIG. 2 Principle of the Smart Material House (Leibinger et al. 2016); ILC precast element (Schlaich und Hückler 2012)

The recent research activity regarding Infra-Lightweight Concrete at the TU Berlin spans several topics. On the one hand, basic material characteristics like the bond and deformation behavior of reinforced ILC have been investigated. The detailed results are described in (Hückler und Schlaich; Hückler 2016). Furthermore a multitude of topics around ILC, e.g. creep and shrinkage, behavior at high temperatures, optimization of strength, water vapor permeability and plenty more (see e.g. Leibinger et al. 2016), have been researched in student's theses.

On the other hand, the applicability of ILC has been investigated within the research project Infra-Lightweight Concrete in multi-story residential buildings (Infraleichtbeton im Geschosswohnungsbau (INBIG)), funded by Zukunft Bau (Bundesinstitut für Bau-, Stadt- und Raumforschung (BBSR)), which aimed at demonstrating the potential of ILC in this specific field. The content of the project will be described in more detail in the following section.

2 POTENTIAL OF ILC FOR APPLICATION IN MULTI-STORY BUILDINGS

Up to now insulating concrete has been mostly used for single-family houses and some special buildings tasks (e.g. churches). A good overview of buildings mainly in Switzerland can be found in Filipaj (Filipaj 2010). In order to prove the material's potential with respect to its load-bearing and insulation capacity and competitiveness on today's construction market the research project Infra-Lightweight Concrete in multi-story residential buildings (INBIG) was initiated, which started in 2014. It is carried out at the TU Berlin as a cooperation of architects (Chair for architectural design and construction, Prof. Leibinger), civil engineers (Chair of Conceptual and Structural Design, Prof. Mike Schlaich) and climate engineers (Transsolar Energietechnik).

The aim is to illustrate possible applications of the new material with the idea to develop a guidebook for architects, engineers and clients which provides vital information on what can be constructed, and how it should be executed. To achieve this goal, designs of characteristic building types of multi-story residential buildings, like vacant lot, Zeilenbau (linear blocks), point block, and perimeter block have been developed (Fig. 3). The designs included in-situ ILC and precast elements as well as hybrid structures with wooden slabs as precast floors

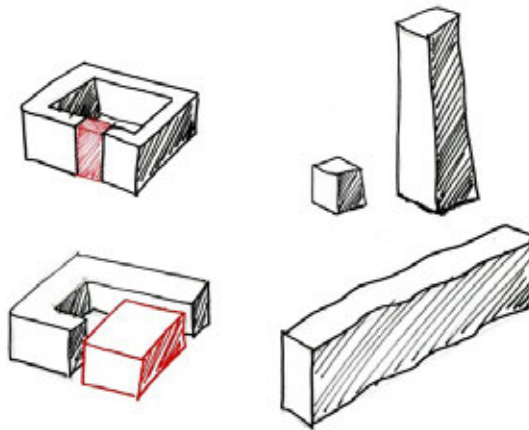

FIG. 3 Typical multi-story residential buildings: vacant lot, point block, perimeter block, linear block (Leibinger et al. 2016)

In a first step, a point block was developed with mostly average features: load-bearing ILC outer wall, common span width of normal concrete slabs, a load-bearing normal concrete core, average window surface ratio etc. This "reference" building was used as a basis for setting up rules of thumb for several parameters, e.g. suitable combinations of wall thickness and ILC mix, maximum number of stories depending on ILC mix, realistic span width of windows, etc.. This information is compiled in a parameter table which shall serve as a support tool and starting point for architects and engineers during the initial design stages.

Subsequently, the designs for the other building types were developed. In the following, short descriptions of the designs at the vacant lots in Berlin, Kantstraße, and the linear block in Berlin, Alte Jakobstraße, are exemplarily provided.

The location of the Kantstraße offers two almost adjacent vacant lots. Since a vacant lot is a favorable set up in terms of heating energy needs, in these cases a wall thickness of 50cm of ILC 800 was sufficient to meet the current German energy consumption requirements. Of most interest are the south facades of the two buildings. For Kantstr. 126 a design was developed where balconies are formed directly from the facade rather than being additional, external elements (Fig. 4). This illustrates the potential of the material for free forming as well as a way to build additive elements with reduced thermal bridges.

The south facade of the other lot Kantstraße 128 was composed of box-like precast elements (Fig. 4). The insulating characteristics of ILC allow for flexible usage of the created space, either as inner or outer area. This facade gives an example of ILC's potential for precast elements. Single elements are self-supporting, surface-finished and can be mounted easily and quickly

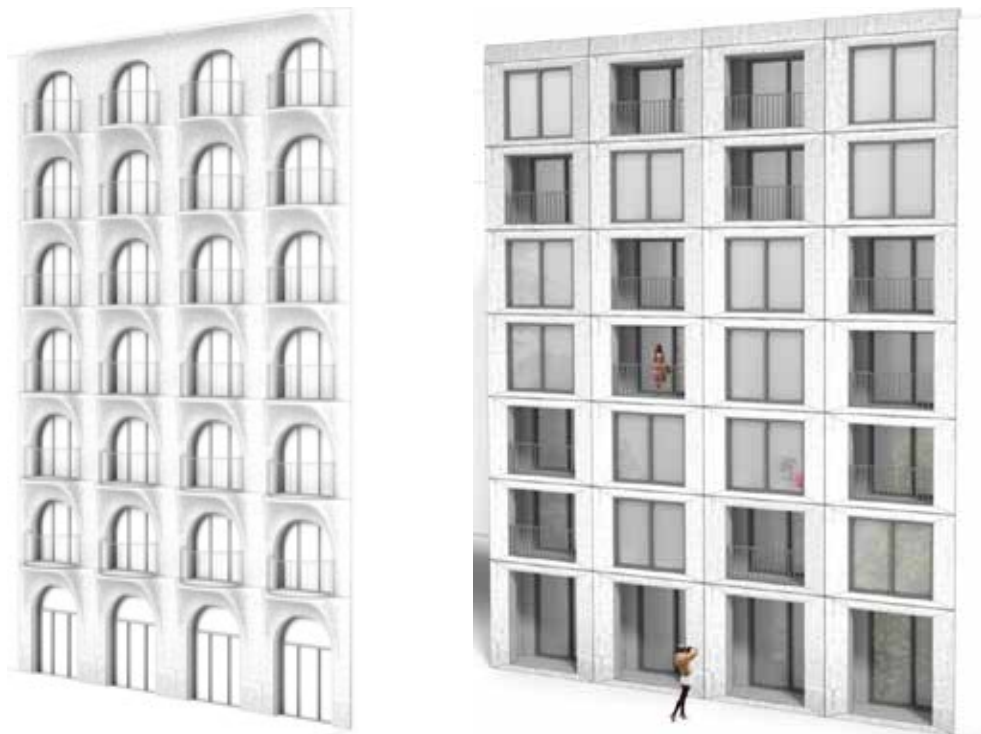

FIG. 4 Schematic building designs: Kantstraße 126 and 128 with load-bearing outer ILC walls (Leibinger et al. 2016)

The linear block in Berlin, Alte Jakobstraße, is composed of identical concrete cores made up of ILC outer precast elements that are connected by wooden slabs (Fig. 5). Due to fire protection regulations the building's height was restricted to 8 stories. Again, ILC enables the varied creation of inner and outer space by flexibly modifying the building's perimeter, creating living spaces, loggias and open terraces. The location within a dense neighborhood evokes the idea of complete precast construction of supporting walls and floors to reduce emissions and construction time.

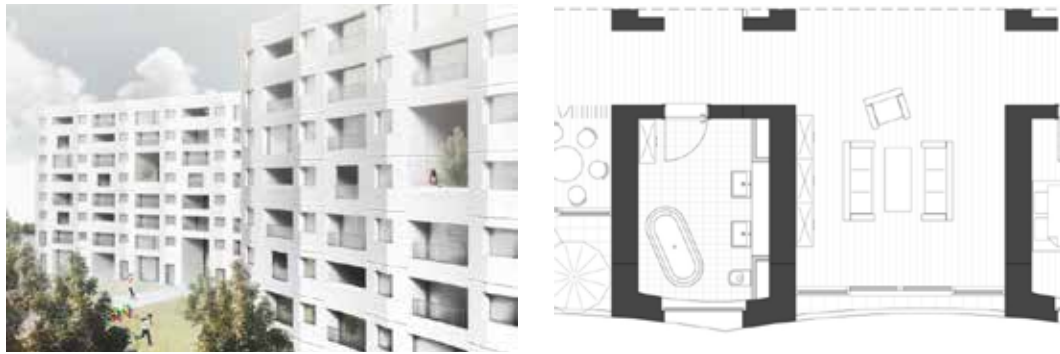

FIG. 5 Zeilenbau (linear block) Alte Jakobstraße (Leibinger et al. 2016)

New materials lead to different types of design and to adjusted structural details. ILC comes with a set of properties that need to be taken into account when designing structural details. Therefore, key details were selected from the designs of the building types mentioned above and further developed (Fig. 6). The aim was to provide simple and robust technical solutions, which follow the idea of, as Prof. Mike Schlaich puts it, "werkstoffgerechtes Bauen" (a construction that is appropriate to material characteristics). To achieve this, simulations of the structural details were carried out to investigate thermal bridge effects and to identify steps for improvement. In addition, the reference building mentioned above was analyzed via thermal simulations to investigate the influence of ILC on the indoor climate.

Some of the developed facades and structural details were subsequently built as 1:1 prototypes (Fig. 7). This served on the one hand to examine the practicability of the construction process. On the other hand some tests were carried out regarding the bending behavior of the ILC balcony slab and the water absorption behavior of the material. In the first case, a slab testing machine was used to subject the ILC balcony to a single vertical load while fixing the normal concrete slab in its position. It could be shown that the ILC element carried the design load as expected. After increased loading failure occurred due to shear load as estimated in preceding calculations. Regarding water absorption, the ILC window prototype was placed into a test setting used for examinations of roof components regarding driving rain impermeability. The results showed a good resistance of the material against driving rain, however, a hydrophobic coating is still advisable to prevent transport of humidity to the inside of the element over time.

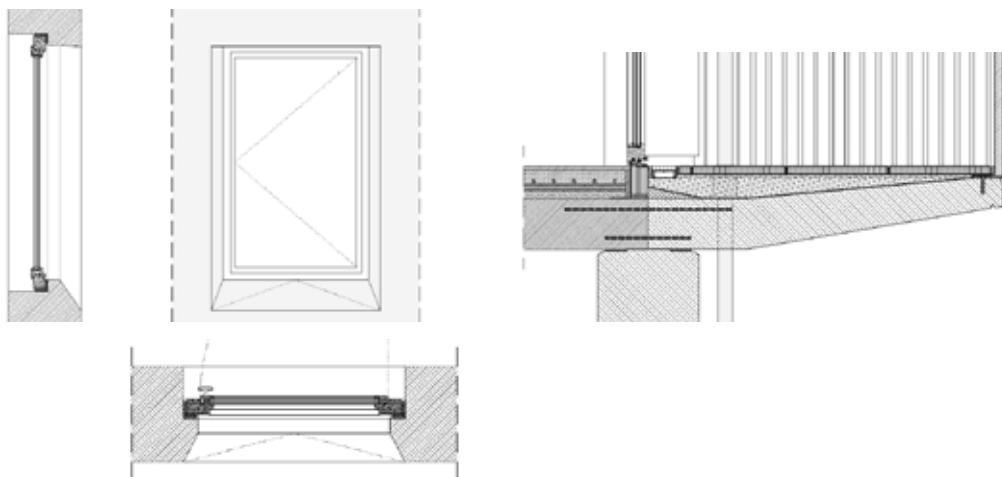

FIG. 6 Exemplary structural details in ILC: window detail (left); ILC balcony connected to normal concrete inner slab (right) (Leibinger et al. 2016)



FIG. 7 ILC prototypes: façade element (2.5m(W)x3.0m(H)), window detail (1m(W)x1.25(H)), ILC balcony with normal concrete slab (2.5m(W)x0.97m(H)x0.8m(D)), surface designs (2.0m(W)x1.8m(H)) and samples 0.5m x 0.5m (Leibinger et al. 2016)

The INBIG project was completed in June 2016 and the methodology and results were described in the final report (Leibinger et al. 2016). Additionally, the findings are currently used to prepare the guidebook, which will contain typical designs for multi-story buildings as well as a collection of standard construction details and recommendations regarding construction processes for Infra-Lightweight concrete.

3 STRUCTURAL BEHAVIOR OF REINFORCED INFRA-LIGHTWEIGHT CONCRETE

Some structural elements of a facade e.g. above large openings like windows or balconies (Fig. 8) are subjected to bending. The load bearing and deformation behavior of structural elements of ILC subjected to bending has been investigated. Lightweight Concrete (LC) with such low densities tends to behave linearly-elastic and is brittle, comparable to Ultra High Performance Concrete (UHPC). A bending design of ILC beams which considers such material behavior has been developed based on theoretical and experimental research. Additionally, the deformation and crack behavior as well as the ductility of ILC beams was an important item to investigate. The first step of a comprehensive experimental investigation was to investigate the interaction between ILC and the reinforcement. Therefore, pull-out tests and tension-stiffening tests has been conducted to describe the bond behavior as well as the crack and deformation behavior of reinforced ILC. Both test set-ups are shown in Fig. 9 and Fig. 10 respectively. The main test parameters were the concrete unit weight (600 to 800 kg/m³), reinforcement bar diameter (8, 12 mm) and the reinforcement material (steel =ST, glass fibre composite = GF).

The results of the interaction tests can be summarized as follows: The characteristic of the bond-slip relationship of ILC is not corresponding to curves for LC according to fib Model Code 2010 (CEB-FIP 2013) as shown in Fig. 11. Due to brittle material behavior, ILC behaves more rigid regarding bonding, which correlates with a steeper increase until decline. This rigid bond behavior results in a favorable crack behavior expressed with a smooth crack distribution, small crack distances and crack widths (Fig. 10). Additionally, a higher tension-stiffening effect arises and results in smaller deflections under tension. These findings were fundamental for the theoretical and experimental investigation of the ILC beams.

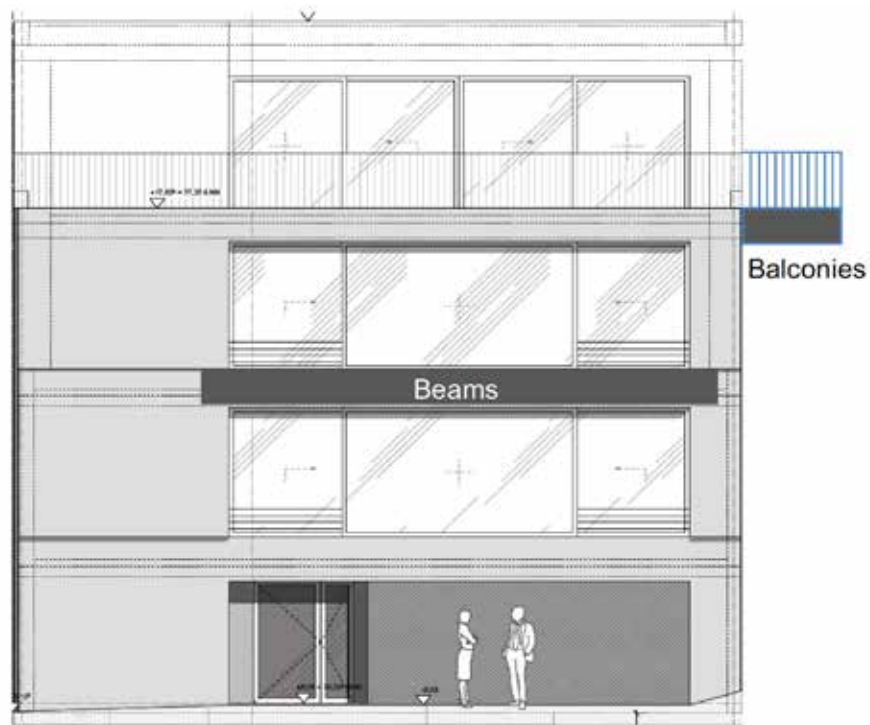

FIG. 8 Structural elements subjected to bending in an ILC-facade



FIG. 9 Pull-out test

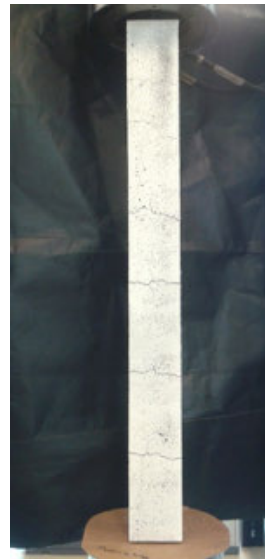

FIG. 10 Tension-stiffening test

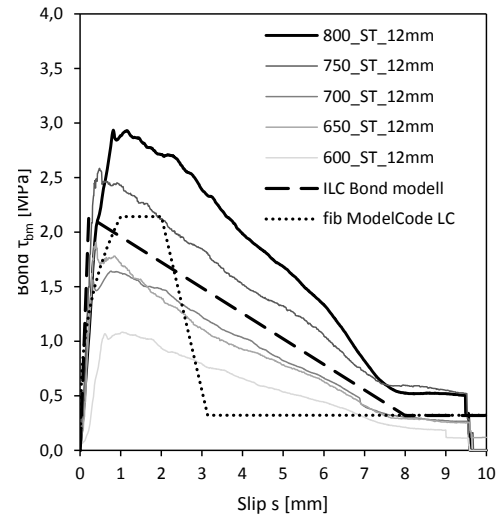

FIG. 11 Bond-slip-relationship of ILC with steel bars

The typical structural elements subjected to bending are beams and balconies. The results of the beam tests (set-up in Fig. 12) allowed a prediction of failure and deflection as a function of ILC grade, reinforcement ratio and material. The main test parameters were again the concrete unit weight (600 to 800 kg/m³), reinforcement bar diameter (8, 12 mm) and the reinforcement material (steel =ST, glass fibre composite = GF). The developed design method for ILC-elements (Hückler 2016) has been successfully applied for a structural design of balcony. The experimental results of the balcony test (Fig. 13) confirmed the theoretical prediction in maximum load and deflection.

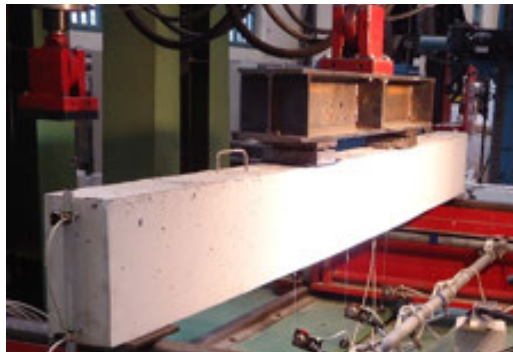

FIG. 12 Beam test

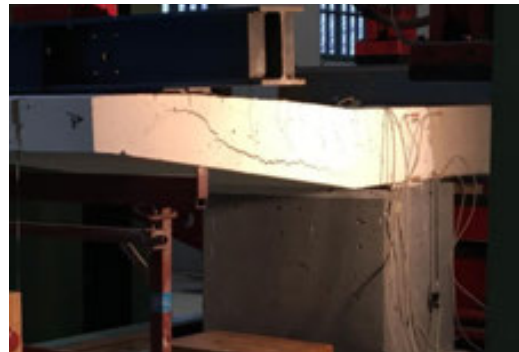

FIG. 13 Balcony test

4 CONCLUSION AND PROSPECTS

Infra-Lightweight Concrete has been researched for more than ten years. The concrete mix has been further developed and shows now an unusual combination of compressive strength and thermal conductivity. The potential of ILC for multi-story residential buildings was investigated and the bending behavior was researched in detail. Therefore, the current state of knowledge about ILC now allows for the construction of multi-story buildings using a monolithic ILC wall while meeting the current energy saving regulations. ILC is hence a real alternative to the market-dominating thermal insulation composite systems.

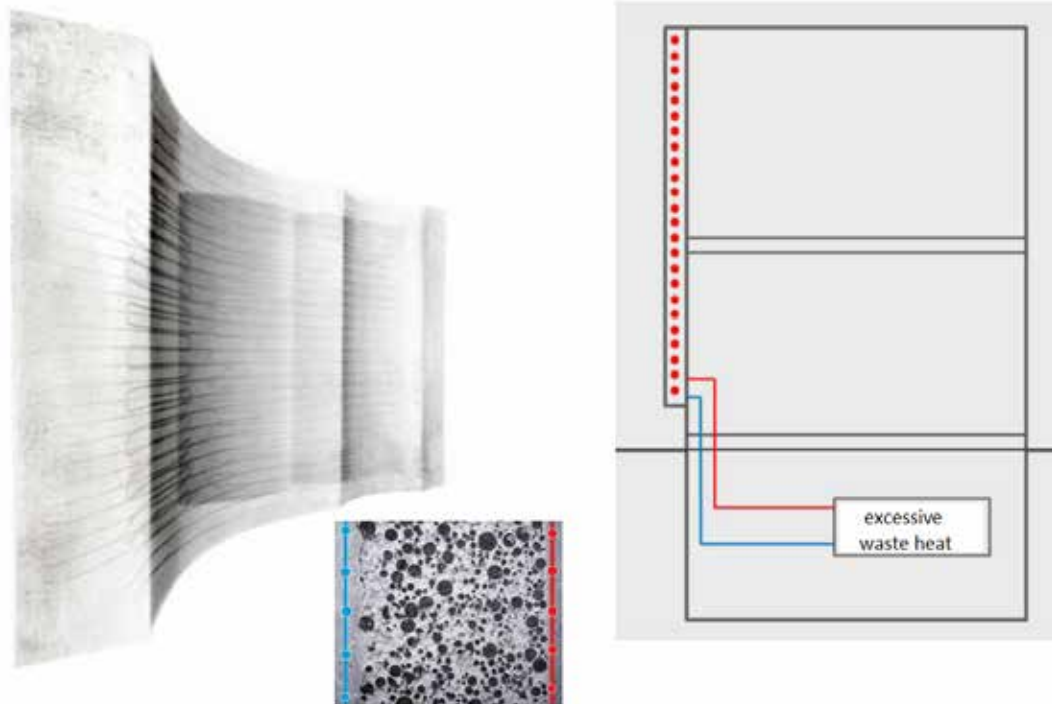

FIG. 14 Active heat insulating system

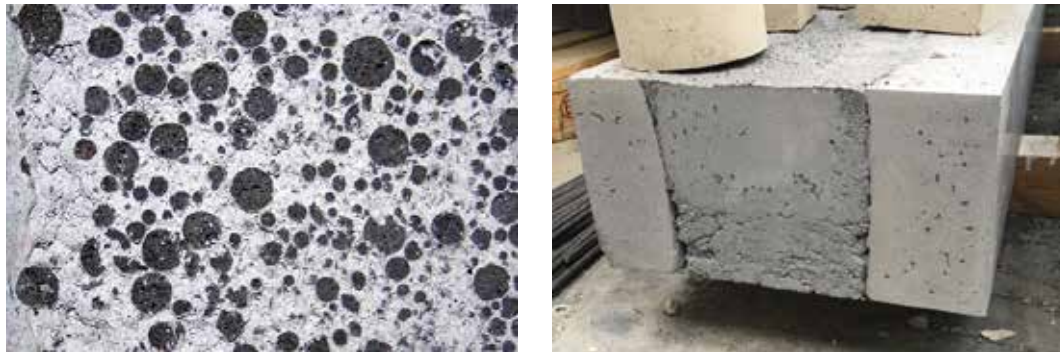

FIG. 15 ILC-members with varying porosity over cross-section: outer, load-bearing shell and inner, insulating core (left: cross section 0.10m(W), right: beam 0.40m(W)x0.2m(H))

The potential for future development of ILC is manifold. Steps in different directions have already been initiated. The improvement of the concrete mix is certainly a continuous task. For example, first tests have been carried out where the aggregate expanded clay was replaced by foam glass with the aim to increase the compressive strength. Further investigations in this matter will follow in the near future.

Another path is the combination of ILC with other techniques. In January 2016, a government funded project started to research multifunctional ILC-members with the aim to combine the material with other features. A multidisciplinary team works on walls where properties such as strength and insulation vary within the cross section (Fig. 15) and which include functions like e.g. active wall insulation (Fig. 14) or photocatalytic air purification (the transformation of air pollutants to harmless substances due to a reaction of photocatalytic active titanium dioxide when subjected to sunlight). The project's goal is to provide an integral approach for a construction method that is resource efficient, environmentally friendly, functional, aesthetical and sustainable.

To extend the application range of ILC to high rise buildings the idea of the "Stabwand", a wall with compression reinforcement that is embedded in ILC to avoid buckling, was developed (Fig. 16). This approach was the basis for the design of a 16 story residential building with ILC precast elements for the ideas competition Urban Living in Berlin (Team Barkow Leibinger 2014). Based on this design, a pilot project for a housing association is currently being planned.

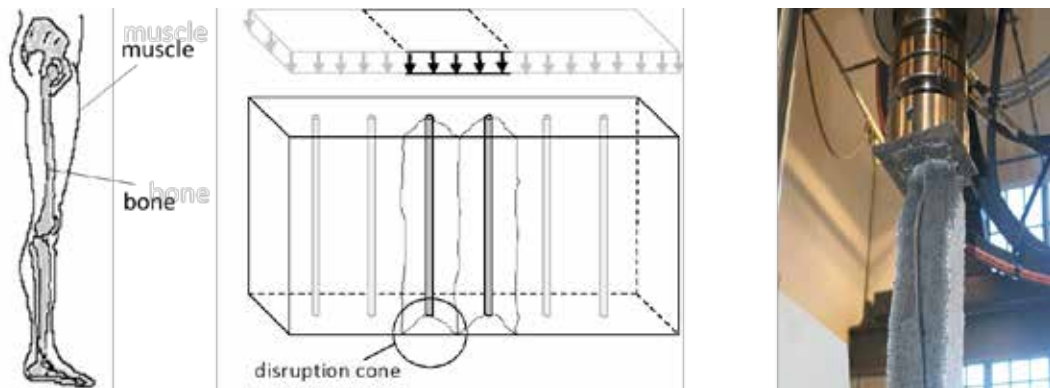

FIG. 16 "Stabwände": Principle of compression reinforcement protected from buckling by surrounding ILC



FIG. 17 "Betonose", Gruber+Popp Architekten



FIG. 18 "Grüne Ecke", Mattes Ringlewski Architekten

As another step towards implementation of the material in the market it is intended to use the findings of the project INBIG mentioned above for future development of precast ILC elements for multi-story residential buildings. Therefore, a subsequent research project is currently set up between the TU Berlin, a housing association and a precast concrete plant that aims at developing precast ILC elements and implementing them in a specific construction project of the housing association.

Besides the pilot project based on Urban Living mentioned above, there are currently various construction projects in preparation where ILC will be put into practice. For example, for a youth center in Berlin Lichtenberg (Fig. 17) and an office building in Heilbronn (Fig. 18) ILC will be used for the outer walls including lintels subjected to bending. Respective structural tests are currently being prepared to obtain technical approval for the building permit.

Acknowledgements

The authors acknowledge the funding of the research initiative "Zukunft Bau" (Federal Institute for Research on Building, Urban Affairs and Spatial Development (BBSR) within the Federal Office for Building and Regional Planning (BBR)), the German Research Foundation (DFG), and the Federal Ministry of Education and Research (BMBF) for financing the research projects described above.

References

- BMVBS (2014): Verordnung über energiesparenden Wärmeschutz und energiesparende Anlagentechnik bei Gebäuden. EnEV 2014. In: Bundesgesetzblatt.
- Breit, Wolfgang; Schulze, Joachim; Heese, Christian; Bund, Bianca (2014): Hochwärmedämmende, monolithische Sichtbetonaußenteile aus Architekturleichtbeton. Stuttgart: Fraunhofer IRB Verlag (Forschungsinitiative Zukunft Bau, 2894).
- Brouwers, H.J.H.; Yu, Q. L.; Lorencik, S. (2015): Functional lightweight concrete: aiming at an improved indoor air quality. *Advanced Building Skins*, 3-4 November, Bern, Switzerland. Hg. v. *Advanced Building Skins*.
- CEB-FIP (2013): fib model code for concrete structures 2010. Berlin: Ernst & Sohn.
- Filipaj, Patrick (2010): Architektonisches Potenzial von Dämmbeton. 2., überarb. und erw. Aufl. Zürich: vdf-Hochschulverl. Online verfügbar unter <http://www.vdf.ethz.ch/info/showDetails.asp?isbnNr=3299>.
- Hückler, Alex; Schlaich, Mike: Bond and deformation behaviour of reinforced Infra-Lightweight Concrete (ILC). In: *Proceedings of fib Symposium 2015*, Copenhagen, S. 116–117.
- Hückler, Alexander (2016): Trag- und Verformungsverhalten von biegebeanspruchten Bauteilen aus Infralichtbeton (ILC). Dissertation.
- Leibinger, Regine; Schlaich, Mike; Lösch, Claudia; Rieseberg, Philip; Ballestrem, Matthias (2016): Infralichtbeton im Geschosswohnungsbau (INBIG). Abschlussbericht zum Forschungsvorhaben, Zukunft Bau.
- Lösch, Claudia; Rieseberg, Philip; Schlaich, Mike; Leibinger, Regine; Ballestrem, Matthias: Infra-Lightweight Concrete in Multi-Story Residential Buildings. In: *Economic Forum (Hg.): 10th Conference on Advanced Building Skins*. 3-4 November 2015, Bern, Switzerland, S. 932–941.
- Schlaich, Mike; Hückler, Alex (2012): Infralichtbeton 2.0. In: *BUST 107* (11), S. 757–766. DOI: 10.1002/best.201200033.
- Schlaich, Mike; Zareef, Mohamed El (2008): Infralichtbeton. In: *BUST 103* (3), S. 175–182. DOI: 10.1002/best.200700605.
- Team Barkow Leibinger (2014): Wettbewerb Urban Living. Online verfügbar unter http://www.stadtentwicklung.berlin.de/staedtebau/baukultur/urban_living/download/kma/UL_BarkowLeibinger.pdf, zuletzt geprüft am 02.07.2015.
- Thienel, Karl-Christian (2015): Der Ästhet unter den Baustoffen Leichtbeton - wie gemacht für ökologisches Bauen. In: *context* (3), S. 32–33.

Cellular Lattice-Based Envelopes with Additive Manufacturing*

Roberto Naboni¹, Anja Kunic², Luca Breseghello³, Ingrid Paoletti⁴

- 1 ACTLAB - ABC Department, Politecnico di Milano, via Bonardi 9, Milano, Italy, tel.no. + 39 02 2399 5117, fax.no. + 39 02 2399 5151, roberto.naboni@polimi.it
- 2 ACTLAB - Politecnico di Milano, via Bonardi 9, Milano, Italy, anja.kunic@mail.polimi.it
- 3 ACTLAB - Politecnico di Milano, via Bonardi 9, Milano, Italy, luca.breseghello@mail.polimi.it
- 4 ACTLAB - ABC Department, Politecnico di Milano, via Bonardi 9, Milano, Italy, tel.no. + 39 02 2399 5117, fax.no. + 39 02 2399 5151, ingrid.paoletti@polimi.it

Abstract

Rapid industrialization of emerging economies and high material consumption in developed countries are leading to an increasing problem of resource scarcity. As a direct consequence to this claim, designers are challenged to rethink architecture and develop new ways of confronting with materials. A potential answer to this problem can be found in the exploration of computational logics for architectural design and fabrication inspired by the observation of biological formations. In this paper is described a method that encompasses computational design, fabrication and material experiments and performative assessment of full-scale prototypes produced with AM. The design phase employs algorithms for the topology optimization of freeform shapes to determine an optimal material organization according to stress intensity and pathways and inform a custom tessellation system. A performative matrix for the creation of a custom lattice microstructures is defined in a bottom-up manner based on the analysis of the intrinsic potential and limitations of the fabrication system and its interaction with extrinsic environmental forces. Through experiments at different scales the viability of the hierarchical cellular lattice-based envelope is demonstrated as a construction system for free-form lightweight structures, later on clad with fiberglass composites.

Keywords

Cellular lattice, Skin System, Digital fabrication, Additive Manufacturing, Computational Design

- * Full paper published in JFDE / Journal of Façade Design and Engineering, Volume 5, Number 1, 2017.
DOI 10.7480/jfde.2017.1.1427

3d-Printed Low-tech Future Façades – Development of 3d-printed Functional-Geometries for Building Envelopes

Moritz Mungenast¹

- ¹ Dipl.-Ing. Architekt, Assistant Professor, Technical University München, Associate Professorship for Architectural Design and Building Envelopes, Arcisstrasse 21, 80333 München, tel. no.: 0049 89 289 28928moritz.mungenast@hk.ar.tum.de

Abstract

WHY? 3d-printing offers new potentials in fabrication, prototyping or small series in the small scale is already competitive and the digital chain (from digital design to product) is closed by using less resources. The majority of buildings are prototypes, which means they differ in size, function and location. But how can the advantages of 3d-printing be adapted to the macro scale, to architecture? What is the architectural outcome? Material savings and process optimization are urgent topics in the building industry as well. WHAT? Aim of this research project is to include integrated façade-functions, material optimization and choice of material to estimate the potential of 3d-printed building envelopes. This should result not only in a 1:1 mock-up, but in a functional geometry with the chance of a new architectural language and the reduction of technical support. HOW? Different functional requirements of a building envelope are analyzed in regard of an effective functional-geometry and promising combinations are developed.

Keywords

Functional geometry, Additive manufacturing, 3d-printed architecture, Digital fabrication, Integrated façade technology

1 INTRODUCTION

After analyzing the current AM-projects in architecture, for example 'Urban Cabin' by DUS Architects, Karmemaker, Amsterdam and "3d printed concrete Mansion", 2015, WinSun, China

and 'Steel bridge', 2015, MX3D, Amsterdam and '3d printed Steel Knot', 2014, Salomé Galjaard, Team Leader, Arup and 'Office of the Future', 2016, Dubai Future Foundation, Dubai, AUE, it is obvious that the focus of these projects is always on one specific architectural question, the structure. This approach is absolutely right, because architecture is always a constructed form of material to define a space.

The other approach is the question of the impact of AM in the architectural appearance (Gestalt) for example the project 'digital grotesque', 2015, Hansmeyer Dillenburger, ETH Zürich, CH. This project is passing new borders. The approaches listed above are fundamental to the development of an architectural standing on the topic of AM in construction.

In mechanical engineering are already other advantages besides topology-optimization like functional integration, hierarchy complexity and material complexity integrated in the AM design methods. In conclusion to the other optimization topics there is still a great part unexplored on the building industry.

The aim of this research project is to target the potentials of AM in architecture by the means of integrated functions to reduce technical devices in the building. In this matter the building skin is the main focus of the research project.

The building skin (Façade) is a very heterogeneous building component which enhances a set of different functions on a minimal constructive area. These special circumstances are implementing the thought that there is a potential for new developments in regard of functional integration. AM has to a certain amount a great freedom to produce complex geometries economically, depending on the AM process for example FDM or SLS. This means that geometry is the main driver to be looked at in regard of façade functions. This is when the term 'functional geometries' is developed.

The research question is: Is it possible to solve facade functions with geometries? Which are these 'functional geometries' and how can they be integrated and combined in a building skin? To achieve this goal each façade function has to be analyzed in their current geometry and then adapted in regard of the possibility to 3d-print this functional geometry. The material and the AM process are not focus of this research project.

2 METHODOLOGY

The method used in the research project is often used in mechanical engineering to develop structural optimization (lightweight construction) and to tackle functional, material and hierarchy complexities.

The following methods are part of this research project:

Bionics combines biology and technology and is used as a solution space and creative tool, which is predestinated, because it is following the principals of functional, material and hierarchy complexities and their combination which are mostly found in nature (von Gleich et al. 2007). For that reason bionic is used in this research project as method to create systematic form finding and for invention and the possibility to solve functional and hierarchy complexities.

BioGen is a bionic methodology (Badarnah & Kadri, 2015) which has the principle of a parallel evolution. This means that different species develop autonomously similar solutions for the accomplishment of distinguished functions. An analyses and design path matrix were developed to identify examples and merge them in a holistic concept.

The research project incorporates the bionics- and 'research by design' method and adapts it to the façade functions. The following façade functions are selected after their potential for their geometrical optimization ability and are grouped in the following categories

- 1 Openings
 - 1.1 Static: Visual connection
 - 1.2 Dynamic: Natural light control, Natural ventilation control, Passage
- 2 Layers
 - 2.1 Static: Load bearing, Insulation, Weather protection, Thermal separation

The facade functions listed above are investigated by searching for biological solutions on similar functions by different species or artificial geometries. The found analogical geometries are analyzed, compared and evaluated in regard of the ability for transformation into a functional geometry for the façade function.

The selected geometries are processed into a 3D-CAD model, optimized with parametric design tools for example scale, gradient, movement etc. according to the façade function. 3d-printed models are produced to control the outcome and for an iteratively development.

The aim is to find potentials in new combinations of geometries and to use additive manufacturing effectively and to create more performing building envelopes with integrated functions.

3 EXPERIMENT / RESEARCH

3.1 FAÇADE FUNCTION > LAYER > LOAD BEARING > DIRECTED VORONOI

Voronoi are polygonal (most of the time pentagonal and hexagonal) structures in the nature. Those structures appear on shells, skins of animals, bone-structures, butterfly eggs and mushrooms. They can easily adapt to different situations. As they have the characteristic of having polygonal structures, they can easily assemble and fit like a puzzle by showing high static load. In three-dimensional spaces the voronoi structure randomly connects to each other in many different directions and build a stable and light structure.

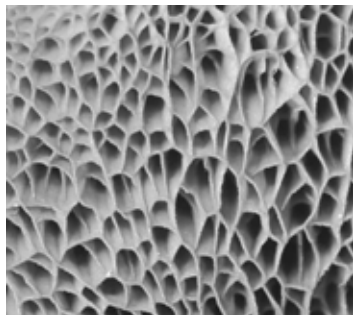

FIG. 1 Voronoi Structure



FIG. 2 Left: Undirected Vornoi Middle: Directed Vornoi Right: Kangome Structure

Voronoi can adapt to all volumes because of its ideal partition in its structure. It can produce regular and random generated structures and therefore it can adapt to the static load by either adding more struts or by thickening them. Openings and closed areas can be precisely defined and therefore add some technical details as for example for the ideal position of the sun history. Another study was made upon the Kangome cells which have a similar structure as the voronoi. The difference is, that the specific structure repeats itself and has not so many different parameters that change its appearance. A study to evaluate the most efficient of the three geometries was set up. Three geometries of the same mass (22gr) were tested to get an indication of the load-bearing capacity: an undirected voronoi, a directional voronoi and a kangome structure. By horizontally spanning the test piece and introducing a vertical load in the center the test has revealed that the directional voronoi had the most viable potential by not breaking and carrying up to 57kg.

The voronoi structure, as result from many studies, can be adapted to a supporting structure as well as a facade. With the help of a grasshopper file, the structure can get clear geometric edges or have a more organic form. Different models with gradient in density and material thickness in a double curved volume were created to show the potentials to adapt to different load conditions within one structural element also called topology optimization.



FIG. 3 3d-printed models Left: Density and material thickness Middle: Gradient material thickness Right: Gradient density

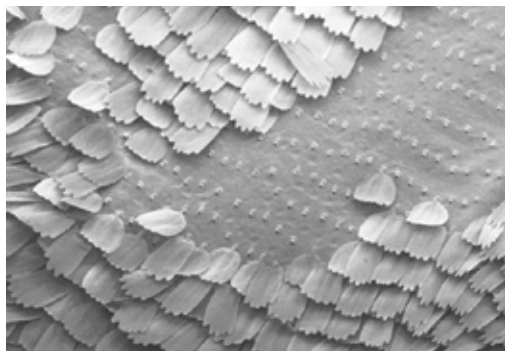

FIG. 4 Butterfly-Wing

3.2 FAÇADE FUNCTION > LAYER > LOAD BEARING > HYPERBOLIC CHANNELS

Inspired by the hyperbolic and porous structures that can be found in butterfly wings, the system was developed with the use of novel computational design, simulation and fabrication processes. In a first research phase the performance and structure of butterfly wings was examined and the underlying geometric pattern, functions and design rules were analyzed, abstracted and transferred into an architectural wall and ceiling system.

The geometry is a tri-continuous morphologic channel system that acts as a multi-functional and highly material-effective building shell. The system consists of three interlocking channels that form a load-bearing structure with each channel having a unique task and morphology. Through generic programming the transportation of temperature, air, water and light inside and outside of the channels can be controlled at any point in the building shell including architectural performance specification.

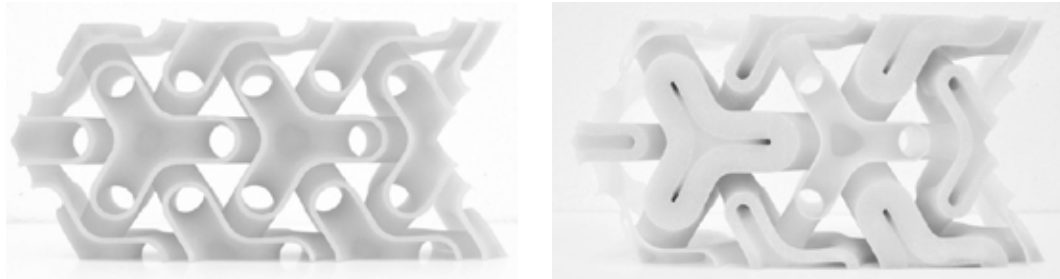

FIG. 5 3d-printed Model: Left: System of three interlocking channels Right: System with variable channel parameters to change the material thickness and intrinsic diameter

3.3 FAÇADE FUNCTION > LAYER > INSULATION > AIR CELLS

Goal was to find the best insulating geometry by researching various existing geometries. The first geometrical difference is the difference between fiber insulations with long stripes of insulating material and cell insulations, which can have open or closed cells. The decision to focus on the cells geometry is ascribed to a higher insulating ability, due to the high percentage of air, and the ability to 3d-print this form.

In an insulating material with a high percentage of air, the component which could be an excellent heat conductor is the material which closes each cell. The existing cell insulating materials are composed by irregular cells which allow a high transfer of heat across the surfaces. The amount of material decreases, by using spherical cells: with equal volume, the sphere occupies less volume and has smaller contact surfaces. To prevent free air circulation between the spheres little triangular plates are added among each sphere. There are two different application options: the first is a rigid insulating panel, suitable to each building by designing a suitable solution for each building. The second option is a flexible insulating panel, which can adapt itself to every surface without a previous design phase. Both solutions are 3d-printable in different scales, dimensions, materials, colors. To avoid the problem of air convection inside the spheres a max. diameter of 2 cm is used.

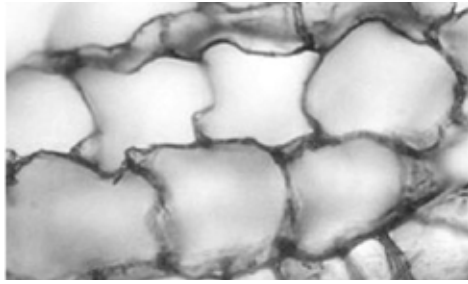

FIG. 6 Cellular structure of cork



FIG. 7 3d-printed model Left: Insulation spheres Right: with triangular plates

3.4 FAÇADE FUNCTION > OPENING > NATURAL VENTILATION CONTROL > AUXETHIC GEOMETRY

An auxethic geometry was the basis of an development of an autoreactive geometry, which expands by tension forces. The auxethic geometry serves as a weather protection and dynamic, self-sufficient regulation of aeration and solar irradiation. These regulative functions are realized in a global expanding or contracting movement, reacting to external parameters, such as temperature and humidity.

Ideally the material itself would react to humidity or temperature. The shell disc layer has been optimized for low material consumption, as well as the substructure, and collects rainwater by its surface relief. In general, the skin can be printed into any freeform shape required.

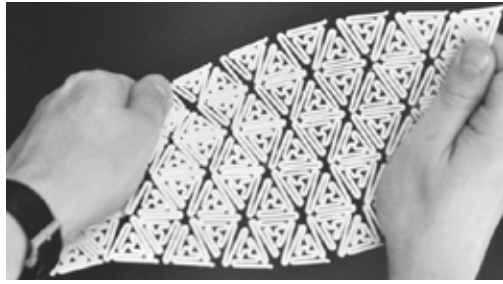

FIG. 8 3d-printed model of an auxetic geometry

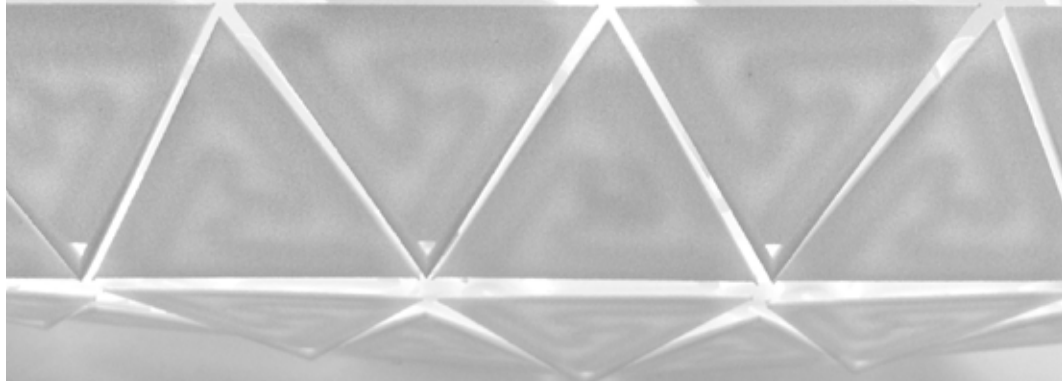

FIG. 9 3d-printed model of an auxetic geometry with weather protection discs and movable ventilation gaps

3.5 FAÇADE FUNCTION > OPENING > NATURAL LIGHT CONTROL > AUTOREACTIVE

The pine cone's folding motion that is related to structural changes like fiber array and hygroscopic properties of its "scales". The structural design of the exoskeleton of a spring tail and its honey comb like extreme light structure. The array and form of the shark's scales constantly self-cleaning surface impossible for habitat of parasites. The body segments of a caterpillar and their ability of sequential swelling and compressing in order to perform all kinds of acrobatic movements and motions like bend, stretch etc. The thermal expansion of wax due to external temperature increase.

All those principles are entreated into one 3D printable geometry with self-shading, self-ventilating properties. 3D printing technology allows the possibility of directly imbedding a thermodynamic material into the inner structure of the multi- material shading and ventilating segments of the facade in order to function without the presence of an external mechanically or electronically driven devices or attachments. This mimicked envelope approach can be parametrically optimized to different climates in the early design stage.

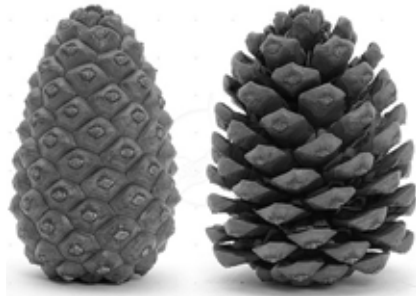

FIG. 10 Hydroscopic movement of pinecone



FIG. 11 Left: Section of volume chamber, Middle and Right: Model with integrated volume chamber to specify the movement with a thermodynamic material

3.6 FAÇADE FUNCTION > OPENING > PASSAGE > TRAPEZOIDAL CHAMBERS

The basic geometry of the “fin-ray-effect” allows to create motion. In the anatomy of fish the fin-rays are responsible for the movement of fins. Their simplified section is based on a triangular system.

The two longer legs of the triangle have connections which divide the triangle into trapezoidal-shaped chambers. These trapezia preserve the flexibility of the system.

A wave-like motion of the hole geometry is initiated by moving its basepoints. With this mechanism a flat fin-like element, which is arrayed along the sides of a triangle to form a three-dimensional module was developed.

In its closed state the module resembles a pyramid with curved faces which then opens up similar to a flower. This movement is controlled with a simple push-pull-mechanism to keep the element as clear as possible and which has the potential to be integrated in the geometry as an autoreactive activator.



FIG. 12 Sketch of Movement of the Fin-Ray Effect



FIG. 13 Pyramid modules of hingeless façade openings

4 RESULTS

The results of the first step are promising in a way that 3d-printed models were produced. The single results of the different functions have to be evaluated and then further developed in single functions or in a combination of functional geometries.

The combination of the layer results has shown a great potential for further development. Especially load bearing (Directed Voronoi) and insulation (Air Cells) as well the integration of hyperbolic channels.

The evaluation of the results is made by a matrix to find out what function and which combination of functions will be further developed in detail.

RESULT LAYERS	STRUCTURAL OPTIMIZATION	FUNCTIONAL OPTIMIZATION	MATERIAL DEPENDENCY	FREEFORM FRIENDLY	FUNCTIONAL COMBINATION FRIENDLY	AUTOREACTIVE ACTIVATOR FRIENDLY
Directed Voronoi	+	+	+	+	+	-
Hyperbolic Channels	+	+	0	0	0	0
Air Cells	+	+	0	+	+	-
Results Openings						
Auxethic Geometry	0	+	-	+	+	+
Autoreactive	0	+	-	+	+	+
Trapezoidal Chambers	+	+	-	-	-	+

TABLE 1 Evaluation matrix of the results + = good 0 = little - = none

5 CONCLUSIONS

Regarding the first research question 'Is it possible to solve facade functions with geometries?', 'Which are these 'functional geometries' and how can they be integrated and combined in a building skin?'

The results of this research project is a first step of developing functional geometries for building envelopes and show a opportunity for the goal of reducing building technology in the near future. The further development of functional geometries and their combination in functional and hierarchy complexities will be essential to the goal of using AM in a holistic way. The matter of material choice and 3d-printing process will affect the next step of integrating and in combining functional geometries.

Methodically is the bionic method combined with research by design in an iterative process promising for the design solutions for functional geometries combined with the AM process. To target the complexity of combinations of different functional geometries in different scales (micro and marco) will need further methods.

In the next step, after all, the architectural design will play an esthetical role and by addressing a new freedom in design there must be answers developed with the integration of functional-geometries.

Acknowledgements

Following students were part of the design team:

Bruno Knychalla, Dominik Bachmann, Luc Morrioni, Elena Gianitsopoulos, Maximilien Peter, Moritz Rieke, Iv Terezof, Maria Chebotarenko, Diego Buonanno, Tommaso Pojero

Fig 1-3: Luc Morrioni, Elena Gianitsopoulos

Fig 4&5: Bruno Knychalla

Fig 6&7: Diego Buonanno, Tommaso Pojero

Fig 7&8: Dominik Baumann

Fig 9&10: Iv Terezof, Maria Chebotarenko

Fig 11&12: Maximilien Peter, Moritz Rieke

References

Ferry, J. D. (1980). *Viscoelastic properties of polymers*, 3rd Ed. New York: Wiley.

Knaack, U., Klein, T., Bilow, M., & Auer, T. (2014). *Facades, Principles of construction*. Basel: Birkhäuser Verlag GmbH.

Badarnah, L., & Kadri, U. (2015). A methodology for the generation of biomimetic design concepts. *Architectural Science Review*, 58(2)

Convective Concrete – Additive Manufacturing to facilitate activation of thermal mass*

Dennis de Witte¹, Marie L. de Klijn-Chevalerias², Roel C.G.M. Loonen³, Jan L.M. Hensen⁴, Ulrich Knaack⁵, Gregor Zimmermann⁶

- 1 Corresponding author [MSc. D. (Dennis) de Witte] Design of Construction, Delft University of Technology, P.O. Box 5043, 2600 GA DELFT, The Netherlands, +31 (0)15 27 84094, d.dewitte@tudelft.nl – Institute of Structural Mechanics and Design, Technical University Darmstadt, Franziska-Braun-Straße 3, 64287 DARMSTADT, Germany, +49 6151 16 23035 dewitte@ismd.tu-darmstadt.de
- 2 MSc. M.L.(Marie) de Klijn-Chevalerias] Unit Building Physics and Services, Eindhoven University of Technology, P.O. Box 513, 5600 MB EINDHOVEN, The Netherlands, +31 (0)40 247 2577, m.l.d.klijn@tue.nl
- 3 [ir. R.C.G.M. (Roel) Loonen] Unit Building Physics and Services, Eindhoven University of Technology, P.O. Box 513, 5600 MB EINDHOVEN, The Netherlands, +31 (0)40 247 2571, r.c.g.m.loonen@tue.nl
- 4 [Prof.Dr.ir. J.L.M. (Jan) Hensen] Unit Building Physics and Services, Eindhoven University of Technology, P.O. Box 513, 5600 MB EINDHOVEN, The Netherlands, +31 (0)40 247 2988, j.hensen@tue.nl
- 5 [Prof. Dr.-Ing. U. (Ulrich) Knaack] Design of Construction, Delft University of Technology, P.O. Box 5043, 2600 GA DELFT, The Netherlands, +31 (0)15 27 84094, u.knaack@tudelft.nl - Institute of Structural Mechanics and Design, Technical University Darmstadt, Franziska-Braun-Straße 3, 64287 DARMSTADT, Germany, +49 6151 16 23013 knaack@ismd.tu-darmstadt.de
- 6 [Dr.-Ing. G (Gregor) Zimmermann] G.tecz engineering GmbH, Angersbachstraße 12b 34127 KASSEL, Germany, +49 561 86 17 555, contact@gtecz.com

Abstract

This paper reports on the research-driven design process of an innovative thermal mass concept: Convective Concrete. The goal is to improve building energy efficiency and comfort levels by addressing some of the shortcomings of conventional building slabs with high thermal storage capacity. Such heavyweight constructions tend to have a slow response time and do not make effective use of the available thermal mass. Convective Concrete explores new ways of making more intelligent use of thermal mass in buildings. To accomplish this on-demand charging of thermal mass, a network of ducts and fans is embedded in the concrete wall element. This is done by developing customized formwork elements in combination with advanced concrete mixtures. To achieve an efficient airflow rate, the embedded lost formwork and the concrete itself function like a lung. The convection takes place with separate pipes on both sides of the concrete's core to increase the charge/discharge of the thermal storage process. The first stage of the research, described in this paper, is to simulate the Convective Concrete at the component level, whereupon a mock-up is tested in a climate test set-up. The paper concludes with describing planned activities for turning this concept into a real building product.

Keywords

concrete, thermal mass activation, computational design support, Additive Manufacturing, advanced formwork, optimization, heat exchange, heat storage

- * Full paper published in JFDE / Journal of Façade Design and Engineering, Volume 5, Number 1, 2017.
DOI 10.7480/jfde.2017.1.1430

POWERSKIN
CONFERENCE



BAU 2017

16.-21. Januar · München

FORSCHUNGSINITIATIVE
ZukunftBAU



DEUTSCHE
AMPHIBOLIN-WERKE
VON ROBERT MURJAHN



DGNB

Deutsche Gesellschaft für Nachhaltiges Bauen
German Sustainable Building Council

DUCON



Glaserhandwerk

JUNG



KÖMMERLING
KÖMMERLING CHEMISCHE FABRIK GMBH



SOLARLUX®

UNIPOR

VFF

Verband Fenster + Fassade

Xia

intelligente architektur



ZUMTOBEL