

Preparation of Load Tests

Lantsoght, Eva; Schmidt, J.W.

Publication date

2019

Document Version

Accepted author manuscript

Published in

Load Testing of Bridges

Citation (APA)

Lantsoght, E., & Schmidt, J. W. (2019). Preparation of Load Tests. In E. Lantsoght (Ed.), *Load Testing of Bridges: Current Practice and Diagnostic Load Testing* (Vol. 12). CRC Press / Balkema - Taylor & Francis Group.

Important note

To cite this publication, please use the final published version (if applicable). Please check the document version above.

Copyright

Other than for strictly personal use, it is not permitted to download, forward or distribute the text or part of it, without the consent of the author(s) and/or copyright holder(s), unless the work is under an open content license such as Creative Commons.

Takedown policy

Please contact us and provide details if you believe this document breaches copyrights. We will remove access to the work immediately and investigate your claim.

Chapter 5. Preparation of load tests

E.O.L. Lantsoght

Politécnico, Universidad San Francisco de Quito, Quito, Ecuador & Concrete Structures, Delft University of Technology, Delft, the Netherlands

J. W. Schmidt

Danish Technical University, Kongens Lyngby, Denmark

ABSTRACT: This chapter discusses the aspects related to the preparation of load tests, regardless of the chosen type of load test. After determination of the test objectives, the first step should be a technical inspection of the bridge and bridge site. With this information, the preparatory calculations (assessment for existing bridges and expected behavior during the test) can be carried out. Once the analytical results are available, the practical aspects of testing can be prepared: planning, required personnel, method for applying the load, considerations regarding traffic control and safety, and the development of the sensor and data acquisition plan. It is good practice to summarize all preparatory aspects in a preparation report, and provide this information to the client/owner as well as to all parties involved with the load test.

1 INTRODUCTION

This chapter gives an overview of the steps that are carried out to prepare for a load test, regardless of the type of load test that is selected to meet the objectives of the test. These general considerations include formulating the specific objectives of the test, carrying out a technical inspection of the bridge, carrying out preliminary calculations, and then developing the practical aspects of the test.

It is good practice to report the preparation of the load test in a preparation report. The first item that should be included in this report are the test objectives. In a first step, in the previous chapter, the test objectives were explored from the point of view to decide whether or not a load test should be carried out. Once it is decided to carry out a load test, the test objectives should be clearly stated and agreed upon with the bridge owner and/or client. These objectives then form the basis for the preparation of the load test: which information about the bridge is needed, which calculations should be carried out, and how should the load be applied and the responses

be measured in such a way that the required information to meet the test objectives can be collected during the field test.

Since the available time on site during a load test is usually limited, a good preparation is necessary to streamline all activities on site. For this purpose, a technical inspection of the bridge and bridge site should be carried out before any other preparation steps are done. For an existing bridge, the inspection should focus on two aspects: the condition of the bridge, and possible site limitations. The condition of the bridge should be documented with photographs. Maps of deterioration, cracks, and other forms of damage should be developed based on the inspection. The effects of deterioration should then also be taken into account for the preparatory calculations. The structure should be inspected for changes with respect to the available plans, such as widening or a different lane layout, and special attention to the joints and bearings should be paid. Secondly, the bridge site should be investigated. Limitations with regard to the application of sensors, application of the load, transport of the load to and from the site, and possible hazardous situations should be evaluated and reported. When a load test is carried out on a new bridge, the technical inspection should focus on possible details that deviate from the design plans, and possible restrictions on the site for carrying out a load test.

The preliminary calculations for an existing bridge serve two purposes: carrying out the assessment calculations based on the Unity Check or Rating Factor, and predicting the behavior of the bridge during the test. For a new bridge, the design calculations are available, and the analytical models may be readily available. In that case, only the expected structural responses for the test load should be taken from the available model if a finite element model was used for the design. The model can be updated with the tested properties of the materials that were used for construction. For existing bridges, the assessment calculations may be available in an evaluation report of the structure. These calculations should be checked, and where the technical inspection identified changes to the structural system or deterioration, these effects should be considered in the assessment calculations. The second type of calculations, which are used to predict the behavior of the bridge during the test and the expected magnitude of the structural responses, should be carried out based on average material parameters and by omitting all load and resistance factors. Since load testing often has the purpose to reduce the uncertainties with regard to the behavior of the tested bridge, these exploratory calculations can only give an indication of the expected behavior. To cover these uncertainties, a range of values or situations (such as comparing the results with and without composite action) can be considered in the preparatory calculations.

Once the goals of the test are defined, the bridge is inspected, and its behavior is estimated with preliminary calculations, the practical preparations for the test can be done to ensure efficiency at the test site. An overall planning of the activities on site should be made, as well as a detailed planning which identifies who will be carrying out which task, when, and with which equipment. A second element is determining how the load will be applied, and where. The load can be applied with dead loads, heavy trucks, or with a test frame and hydraulic jacks. The method of load application, and the position of the load (single position or driving path) depends on the test goals. The safety of the personnel, bridge, and traveling public should be ensured during all activities on site. For this purpose, the possible hazardous situations for the personnel should be evaluated, the preparatory calculations are necessary, and traffic signaling or detours should be developed. Finally, a plan for the application of sensors and data visualization during the test (if required) should be developed. This plan should fulfil the goals during the test (for example, evaluation of the stop criteria during a proof load test), as well as the goals of the post-processing (for example, updating of the developed finite element model with the field observations).

2 DETERMINATION OF TEST OBJECTIVES

Before determining if a load test is the right way to address the open questions with regard to the structure, the test objectives should be clearly stated. Depending on the test objectives, the type of load test can be selected. These elements have been discussed in general terms in Chapter 4. A summary of possible objectives for load tests for new and existing bridges is given in Table 1.

Determining the test objectives is a critical step at the initial preparation of the load test. Since the steps required to prepare and execute the load test, and analyze its results afterwards depend on the goals of the test, defining the test objectives is of the utmost importance. The executing party and owner and/or client should agree on the test objectives early on when a load test is considered for the bridge under study, and write these objectives down in a memo that should be communicated with all parties involved.

Besides determining whether or not load testing is recommended, and which load test should be used, the test objectives are also required for the type, position, and range of the sensors that are applied during the load test. In addition, the test goals determine the sampling rate and type of the data acquisition system, as well as the data processing and visualization. For example, for

a proof load test, immediate data processing and visualization is required so that the stop criteria can be evaluated.

It is good practice to summarize all assumptions, calculations, and decisions that were made prior to the test in a preparation report. This report should state the test objectives, and sketch how these objectives will be met during and after the load test.

Table 1: Examples of goals that can be achieved with different types of load tests, for new and existing bridges.

	Diagnostic load test	Proof load test
New bridge	Verify design assumptions (stiffness, deflection, load distribution)	Demonstrate, prior to opening, that bridge can carry code-prescribed loads (uncommon nowadays)
Existing bridge	Verify structural behavior (stiffness, deflection, load distribution, composite action, rotation capacity at supports, continuity at supports). Verify behavior after rehabilitation/strengthening.	Demonstrate that bridge can carry code-prescribed loads (when loads have changed over time, material deterioration or degradation occurs, uncertainties of behavior at higher load levels are large)

3 BRIDGE INSPECTION

3.1 Inspection results

The first step during the preparation of a load test is the technical inspection of the bridge and the bridge site. A detailed reference that can be consulted on how to conduct a technical inspection is the Bridge Inspector’s Reference Manual (Ryan et al. 2012). The bridge plans available in the archives should be studied prior to the inspection and taken to the bridge site, so that changes with respect to the available plans can be noted and, where possible, measured. Possible alterations to the bridge that may not be shown on the drawings are:

- Widening of the bridge,
- Strengthening projects,
- Actual geometry and reinforcement placing,
- Sound barriers,

- Changes to the lane layout,
- Changes to the width of the shoulder at the edges of the lanes and between the driving directions,
- Changes to the thickness of the wearing surface or asphalt layer.

The joints and bearings should be inspected, so that it can be evaluated if restraint of deformations (for example caused by changes in temperatures) can occur. Frozen bearings (see Figure 1) can be identified by the following observations: bending, buckling, improper alignment of members, or cracks in the bearing seat. Pitting, section loss, deterioration, and the build-up of debris at the bearing can result in frozen bearings as well. If restraint of deformations occurs, and results in additional stresses on the cross-sections, this load effect should be considered in the assessment calculations and preparation of the test. Since these observations depend on the temperature, the temperature during the inspection should be measured and reported (Ryan et al. 2012). If the temperature is above the design temperature, the bearing should be in its expanded position. If the temperature is below the design temperature, the bearing should be in its contracted position. Unless otherwise noted, the design temperature is 18°C or 68°F.



Figure 1. Example of frozen bearing.

During the inspection of concrete bridges, a map of the cracks and deterioration should be drawn, along with the related cause. This map should represent the length, direction, and width of the cracks to scale for the accessible faces of the structure. For example, for slab bridges, the crack map should include the bottom face, side faces, and the top face if no wearing surface is provided. For girder bridges, the bottom and side faces of the girders should be presented, as well as the bottom of the deck, and when no wearing surface is applied, the top face of the deck. The width of cracks with a width $w \geq 0.15$ mm (0.006 in) should be indicated on the map of cracks. Additionally, regions with material damage and degradation should be marked on the drawing with the map of cracks. Examples are positions of delamination, and where rebar corrosion can be observed. A possible method for developing the map of damages is to mark the cracks with a marker, and to make photographs of the accessible faces of the structure. For reference, a grid can be drawn on the faces. The photographs can then be compiled in photo editing software. Special attention should be paid to the scale, which should be the same in all photographs, and possible effects of wide-angle lenses and other sources of distortion of the photographs. Once all photographs are combined to represent the entire face of the bridge that is studied, the marked cracks can be drawn by hand over the photograph in the editing software, and saved as a separate layer. When the layer with the photographs is disabled, the drawing of the crack map (including other forms of damage where relevant) remains. An example of an inspection map which depicts damages, is shown in Figure 2.

During the inspection of steel bridges, the position of signs of corrosion, fatigue damage, and fracture-critical details should be identified, and represented on a drawing of the occurring damage. This drawing should show all accessible faces of the structure. For box and tub girders, the inspection and drawing of the occurring damage should include the inside of the box or tub.

During the inspection of timber bridges, all positions with material damage and degradation should be identified and represented on a drawing. This drawing should show all identified damage, represent it on scale, and cover all accessible faces of the structure.

During the inspection of masonry bridges, a map of cracks should be developed in a similar way as the map of crack for concrete bridges. Additionally, where the mortar of the joints is degraded, and where bricks are missing, this damage should be included on the drawing that represents the condition of the structure. Other forms of observed material degradation and damage should be added as well. The drawing should cover all accessible faces of the structure.

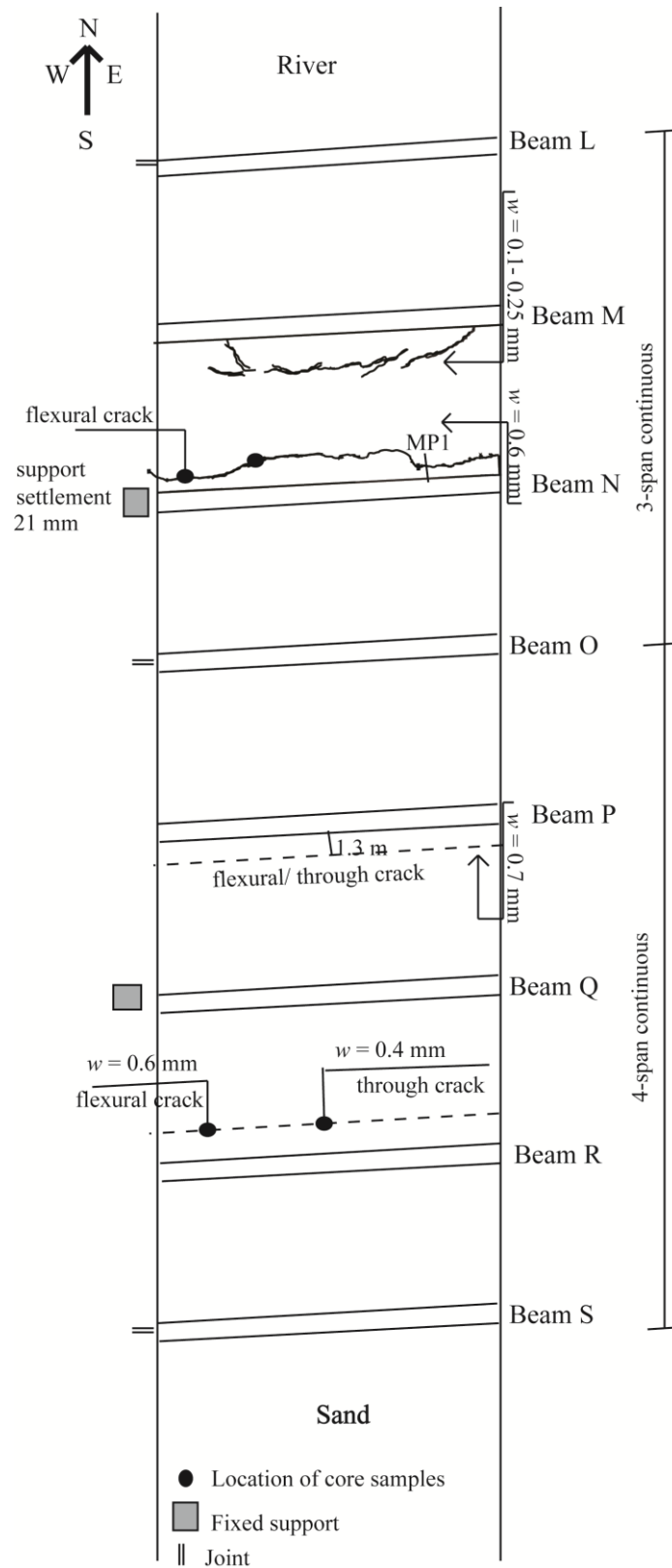

Figure 2. Example of map of damages. Reprinted with permission from ASCE from (Lantsoght et al. 2016). Conversion: 1 mm = 0.04 in, 1 m = 3.3 ft.

During the inspection of bridges using Fiber reinforced plastics (FRPs), special attention should be paid to damages and material degradation. In particular, delamination due to concentrated load exposure and adhesive joint locations should be checked in combination with durability deterioration caused by UV light, ozone, temperature, and humidity. A drawing representing the positions, type, and severity of the observed damage for all accessible faces of the structure should be prepared.

3.2 Limitations of testing site

Besides the inspection of the bridge to be tested, the bridge site and its accessibility should be checked during the inspection. Possible obstructions for the measurements, the load application, and the access of personnel to the site should be identified. Examples of limitations to the test site include:

- elevated sidewalks on the bridge, which makes measuring and marking sensor and load positions more difficult,
- restrictions to the access to the bridge structure, or limited space (or height) under the bridge or at the side faces,
- restrictions related to the access to the bridge site itself,
- restrictions caused by roadway or waterway traffic under or on (parts of) the bridge that may not be halted, or only when a special exception is granted for a short amount of time,
- obstructions that complicate the application of sensors to the bridge.

The restrictions regarding roadway or waterway traffic that cannot be halted significantly impact the load test. Especially if the bridge cannot be closed for traffic during the load test (see Figure 3 for an example), the effect of the passing traffic on the measured structural responses cannot be ignored. This situation is not desirable, but is sometimes necessary because of the accessibility to certain towns or dwellings. When the bridge cannot be closed for traffic during the test, the safety aspects need to be considered in even larger detail. At all times, crossing the bridge should be safe for the traveling public. When the load is applied through trucks, the truck drivers should be alerted about the passing of traffic on, for example, the remaining lanes of the bridge. When a proof load test is carried out, the structural responses should be followed in detail, the stop criteria should be checked meticulously, and at no point the load magnitude should cause danger to the traveling public, in terms of performance of the bridge, presence of large

amounts of counterweights, or possible collapse of the structure. In general, it is not recommended to allow traffic on a bridge during a proof load test. If closing is not possible, a temporary closing when the largest load levels are applied should be considered.

These limitations regarding access to the bridge structure and the test site need to be considered when choices are proposed during the preparation stage. They will influence the safety plan, sensor plan, loading protocol, and possibly the type of sensors that are selected as well as the way in which the load is applied.



Figure 3. Proof load test on viaduct where one lane of traffic (right side of photograph) remains open for traffic (Fennis et al. 2014, Koekkoek et al. 2015).

4 PRELIMINARY CALCULATIONS AND DEVELOPMENT OF FINITE ELEMENT MODEL

4.1 Development of finite element model

An important part of the preparation of a load test, is the development of a (linear) finite element model of the possible test bridge. Not all codes (for example the Manual for Bridge Evaluation (AASHTO 2016)) require that a finite element model is developed prior to the load test. In fact, depending on the objectives of the load test, it is not always desirable to develop a finite el-

ement model. In some cases, simplified analytical calculations are sufficient and keep load testing and attractive and reasonably economic option. The codes and guidelines that do not require a finite element model mention that the field test can be used to update the analytical model that is used for rating the structure. The analytical model can be of varying levels of detail and complexity. For new bridges, finite element models are often available as part of the design calculations. For existing bridges, this model serves the following purposes:

- It is used for the assessment (or rating) of the bridge prior to the test. Sometimes, the assessment based on a refined finite element model will show that the bridge fulfills the code requirements, and it may then be decided that a field test is not necessary.
- It will be used to identify the loading positions and the critical positions for which the structural response should be monitored during the test. The magnitude of the expected response is necessary to require the type and measurement range of the sensors.
- It can be used to identify overall structural behavior, such as stiffness and transverse load distribution, prior to the test. This behavior can then be compared to the measured responses during the test. Additionally, developing a finite element model gives the engineer a better understanding of the behavior and details of the bridge. Prior to the load test, the model can be used to evaluate the influence of certain factors: the stiffness of non-structural members such as barriers and parapets, unintentional restraint at the bearings, and other factors that typically are not considered during assessment. To evaluate the importance of these factors, for example the effect of the non-structural members, two models can be developed: a model with and a model without the non-structural members. The responses from these two models can then be compared to evaluate if the influence of the studied factor is significant. Similarly, for composite bridges, two models can be developed: one in which no composite action occurs, and one with the composite cross-section. The responses can then be compared, and can be used to evaluate the structural behavior during the field test (Zhou et al. 2007).
- If the preparations are carried out according to different Levels of Approximation as described in the *fib* Model Code for concrete structures (fib 2012), the results of hand calculations can be compared with the results in the model. For example, for transverse distribution, the distribution factors from codes such as the AASHTO LRFD code (AASHTO 2015) can be used to have a first idea. Additionally, the method of Guyon-Massonet can be used as a first approximation, or the recommendations from ACI 342R-16 (ACI Committee 342 2016) for concrete bridges. The results from a simplified analytical method can be compared with the results from the finite element model.

- After a diagnostic load test, the model should be updated based on the responses measured in the field, and used for the assessment (or rating) of the bridge after the test.

When the finite element model is used to identify the critical loading positions and the magnitude of the load in a proof load test that corresponds to the factored live load combination, a model with shell elements is sufficient (Lantsoght et al. 2017a). If structural responses such as strains over the height of the cross-section should be determined prior to the test, for example to prepare the stop criteria, solid elements are necessary.

For concrete bridges, in the linear finite element model the uncracked cross-sectional stiffness can be used together with a Poisson ratio of 0.15. Guidance for the modeling with nonlinear finite elements is given in guidelines such as the Dutch Guideline (Rijkswaterstaat 2017). When a concrete bridge is susceptible to a brittle failure mode, or when a steel bridge has fracture- or fatigue-critical details or possible structural stability issues, a nonlinear finite element model is recommended to analyze the structure in more detail and compare the responses from the model during the test with the measured responses. This nonlinear finite element model will also give a more precise estimate of the responses in concrete bridges after cracking and redistribution occurs.

The loads that are applied in the finite element model are the loads that are used for the assessment of the bridge. For a proof load test, the load combination with these loads should result in the same sectional moment or force (depending on the studied failure mode) as the applied load during the test. The following loads are typically modelled:

- Self-weight,
- Superimposed dead load,
- Live load,
- Loads or effects such as temperature changes that lead to stresses on the cross-section as a result of a restraint of deformation, or such as support settlements (if any) that change the distribution of sectional moments and forces.

The self-weight is modeled based on the load resulting from the material density. If a simplified model is used, in which the geometry is simplified, then the equivalent load of the omitted parts should be added as an external load.

For bridges with a superimposed dead load resulting from an asphalt layer, the resulting load can be determined based on a volume load of $23 \text{ kN/m}^3 = 0.15 \text{ kip/ft}^3$. The thickness of the as-

phalt layer can be taken from the structural plans. However, if additional layers have been added over time, the value in the plans may be unconservative. For that case, it is recommended to determine the thickness based on drilled core samples, or by using a nondestructive test method.

The live loads that are applied on the bridge depend on the considered code. The live load model typically consists of distributed and concentrated loads, for example as defined in AASHTO LRFD (AASHTO 2015) and NEN-EN 1991-2:2003 (CEN 2003). The distributed loads can be distributed lane loads, pedestrian loads, and distributed loads on the remaining area. The concentrated loads can be design trucks or design tandems placed in the bridge lanes. The notional lane width that is prescribed in the codes should be used; this lane width and the resulting layout can be different from the actual lane layout of the structure. For the design trucks or tandems, the position should be sought that results in the largest load effect. This position should give the most unfavorable case, which is governing for assessment.

When shell elements are used in the finite element model, the distribution of the concentrated wheel prints over the layer of asphalt and to the middle of the cross-section should be considered. An approximation for finding the resulting wheel print at the middle of the cross-section is to use a vertical distribution under 45° , as shown in Figure 4.

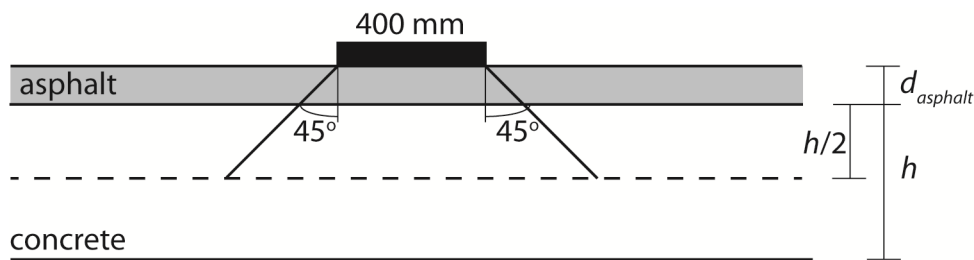

Figure 4. Distribution of wheel print to center of cross-section, applied to a concrete bridge, showing the tire contact area from NEN-EN 1991-2:2003. Conversion: 1 mm = 0.04 in.

4.2 Assessment calculations

For new bridges, the design calculations are available, and the preparation before the load test is limited to reading out the expected structural responses from the analytical model used for the design. For existing bridges, two types of preliminary calculations should be carried out: assessment calculations to evaluate if the bridge fulfills the code requirements, and calculations to predict the behavior during the test and the bridge's maximum capacity. The assessment calculations are based on load and resistance and characteristic material properties, whereas the calculations to predict the behavior are based on average values for the material properties and take all load and resistance factors equal to one.

The assessment calculations can be carried out with a combination of finite element models, hand calculations, or spreadsheets that automate hand calculations. These tools should be developed as part of the preparation stage of the load test. After the test, these tools can be reused to develop the improved assessment of the bridge, taking into account the field measurements.

The assessment calculations are carried out based on a Unity Check or a Rating Factor. The Unity Check is the ratio of the factored load effect as caused by the load combination to the factored resistance:

$$UC = \frac{\text{Load effect due to factored load combination}}{\text{Factored capacity}} \quad (0.1)$$

If the Unity Check is larger than one, it is concluded that the bridge does not fulfil the code requirements. Unity Checks can be calculated based on simple hand calculations, which are typically more conservative than the Unity Checks that result from using refined finite element models (Shu et al. 2015, Lantsoght et al. 2017c).

The Rating Factor (AASHTO 2016) gives the available capacity for live loads. If the Rating Factor is smaller than one, the available capacity is insufficient. Just as for the Unity Checks, different approaches can be used, from fast conservative hand calculations to more time-consuming refined finite element models. The Rating Factor RF for LRFR is calculated as follows according to the Manual for Bridge Evaluation (AASHTO 2016) Eq. 6A.4.2.1-1:

$$RF = \frac{C - (\gamma_{DC})(DC) - (\gamma_{DW})(DW) \pm (\gamma_P)(P)}{(\gamma_{LL})(LL + IM)} \quad (0.2)$$

with, for the Strength Limit States:

$$C = \phi_c \phi_s \phi R_n \text{ with } \phi_c \phi_s \geq 0.85 \quad (0.3)$$

and for the Serviceability Limit States:

$$C = f_R \quad (0.4)$$

where:

RF = rating factor

C = capacity

f_R = allowable stress specified in the LRFD Code (AASHTO 2015)

R_n = nominal member resistance (as inspected)

DC = dead load effect due to structural components and attachments

DW = dead load effect due to wearing surface and utilities

P = permanent loads other than dead loads

LL = live load effect

IM = dynamic load allowance

γ_{DC} = LRFD load factor for structural components and attachments

γ_{DW} = LRFD load factor for wearing surfaces and utilities

γ_P = LRFD load factor for permanent loads other than dead load = 1.0

γ_{LL} = evaluation live load factor

ϕ_c = condition factor

ϕ_s = system factor

ϕ = LRFD resistance factor

The load factors can be found in Table 6A.4.2.2-1 in the Manual for Bridge Evaluation. The condition factor depends on the observed deterioration and is given in Table 6A.4.2.3-1 of the Manual for Bridge Evaluation. The system factor considers redundancy in the structural system and is given in Table 6A.4.2.4-1 of the Manual for Bridge Evaluation. A bridge with less redundancy is more failure-critical, which is represented by a lower rating.

For concrete bridges, if the load effect is determined based on a finite element calculation, the effect can be averaged over a certain width in the transverse direction. For bending moment in reinforced concrete slab bridges, the peak can be averaged over 3 m (9.8 ft) in the transverse direction, or another width that corresponds to local practice (Lantsoght et al. 2017a). For shear in reinforced concrete slab bridges, the peak shear stress can be averaged over $4d_l$, with d_l the effective depth to the longitudinal reinforcement (Lantsoght et al. 2017b). An example is shown in Figure 5. For other types of structures and materials, the local rules of thumb can be followed, or a sensitivity study can be carried out to identify a suitable transverse distribution of the peak of the load effect.

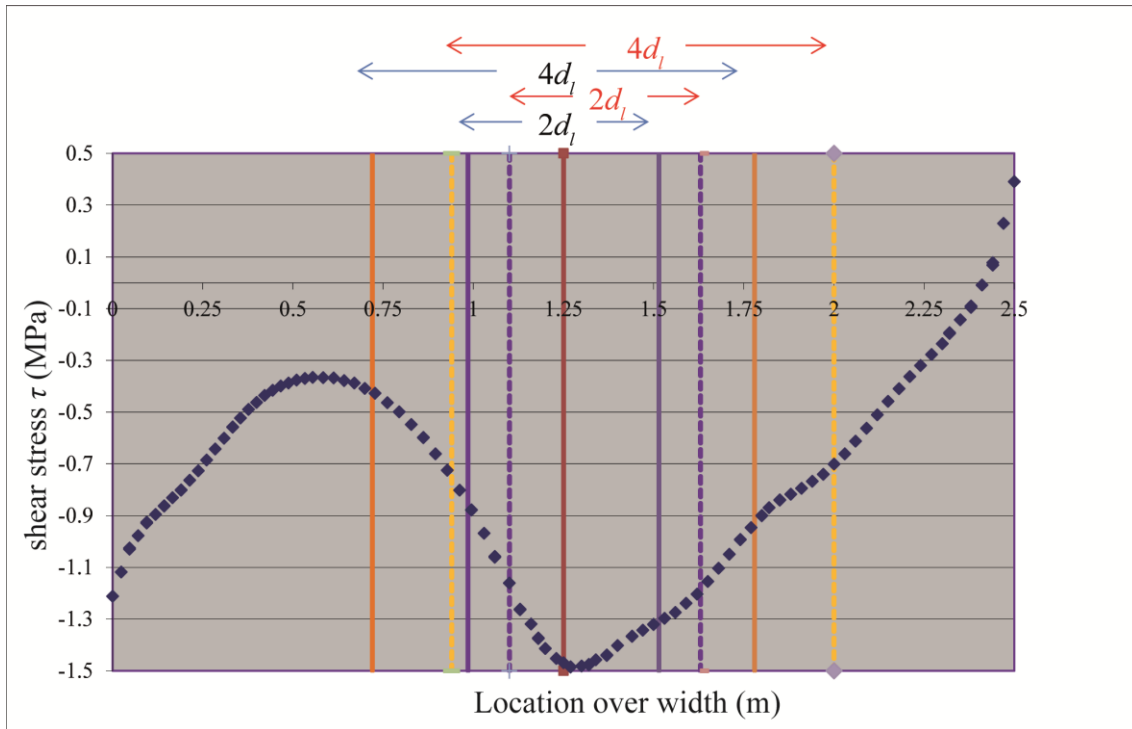

Figure 5. Example of distribution of shear stresses in transverse direction in reinforced concrete slab tested in the laboratory with 7 bearings for the support. Due to small imperfections, the slab did not rest on all bearings at the beginning of the test, resulting in an asymmetric stress profile. Conversion: 1 m = 3.3 ft, 1 MPa = 145 psi. Adapted from (Lantsoght et al. 2017b)

A steel bridge is considered fracture-critical when it contains fracture-critical details. A concrete bridge is considered shear-critical when the Unity Check for shear is larger than for bending moment, or when the Rating Factor for shear is smaller than for bending moment. Special precautions should be taken for proof load testing of shear-critical or fracture-critical structures, as high loads are involved. For diagnostic load testing, the applied loads are smaller and the involved risk is smaller, but the fact that the structure is fracture- or shear-critical should be taken into account during the preparation stage, and critical responses should be monitored during the test.

All information from the technical inspection should be taken into account for the assessment calculations. If material parameters have been determined from sample tests, the resulting characteristic values can be used. If section losses have occurred, the reduced areas and moments of inertia should be used for the assessment.

When assessment calculations are available with the documentation of the bridge under study, the assumptions made for these calculations should be verified. It is not sufficient to simply report the resulting Unity Check or Rating Factor from the available reports. The as-

assumptions that were made, for example with regard to section losses or restraint of bearings, should be reported and it should be evaluated if these assumptions are still valid, or if new assessment calculations should be added.

When in the available documentation with reported Unity Checks or Rating Factors the assumptions are not given, the assessment calculations should be repeated. It is of the utmost importance to report and document the assumptions that lie at the basis of the available assessment calculations. When these calculations and load tests are used to make official decisions with regard to posting, strengthening, or closing an existing bridge, all steps that lie at the basis of this decision should be reported and available for reference in the future.

4.3 Estimation of bridge behavior during load test

The second type of calculations that need to be carried out prior to a load test are the calculations that are used to estimate the bridge behavior during the load test. These calculations should be based on average (measured) material parameters, and capacity expressions without the resistance factor. The calculations should represent the actual situation of the bridge as closely as possible. For new bridges, the average material properties can be used as input in the analytical models used for the design, and the resulting expected response can be obtained. For existing bridges, section losses, reduction of the capacity caused by material damage or degradation, and other factors that may have been identified during the technical inspection should be taken into account. When additional load carrying mechanisms that can increase the capacity of the structure are expected, the influence of these mechanisms can be explored through sensitivity analyses. Moreover, the calculations should identify the expected failure mechanism and associated maximum load.

For truss bridges, the maximum load should be determined by evaluating the tensile and compressive strength of the critical truss member. The maximum load in compression should consider the structural stability of the member.

For arch bridges, the maximum compression in the arch should be determined based on the compressive strength as well as the structural stability of the arch. If the bridge is a tied arch, the maximum capacity of the deck should be determined by studying the bending moment capacity, shear capacity, and tensile capacity. For the bending moment capacity, the interaction with the occurring tension should be considered. For the shear capacity of a concrete deck, the reduction in capacity caused by the applied tension should be considered.

For steel girder bridges, in general the capacity in bending, shear, and normal force should be calculated, and all stability-related failure modes should be verified, to identify the most likely failure mode and its associated maximum load. The effect of fatigue and resulting reduction of the capacity should be considered.

For concrete bridges, the capacity in bending moment, shear and punching should be verified. If elements are subjected to normal forces, the interaction of these forces to bending moment, and shear and punching should be considered. For slender compression members, the maximum load taking into account structural stability issues should be determined. For concrete girder and slab bridges, the bending moment capacity can be determined for a cross-section at mid-span and a cross-section over the support. If the height of the cross-section is variable and/or the reinforcement layout changes throughout the span, a representative number of sections should be checked. For the studied sections, it is recommended to determine the following capacities without safety factors on forces and materials:

- Ultimate bending moment resistance based on average material properties,
- Moment-curvature diagram based on average material properties,
- Maximum applied load from vehicle or test tandem that causes yielding of the tension reinforcement,
- Maximum applied load from vehicle or test tandem that causes flexural failure,
- Shear resistance based on average material properties,
- Maximum applied load from vehicle or test tandem that causes shear failure,
- Punching shear resistance based on average material properties,
- Maximum applied load from vehicle or test tandem that causes a punching shear failure,
- Load-displacement diagram based on average material properties, which can be used for field test verification,
- Initiation of the first cracks based on the cracking moment,
- Thresholds related to the stop criteria, for proof load tests for failure modes and bridge types where no codified stop criteria are available.

4.4 Shear capacity considerations

Concrete shear failure is often described as a brittle and unwarned failure mode, where only limited deformations occur before initiation of the critical shear crack. Consequently, special attention and thus considerations with regard to this failure mechanism should be undertaken before loading of the bridge. This means that the shear capacity has to be evaluated as accurately as possible. If mechanisms are available that can increase the shear capacity as compared to the code-prescribed capacity, the effect of these mechanisms should be studied. For example, if plain bars are used, or if transverse redistribution can occur as in slab bridges, the expected increase in the shear capacity should be considered, and the maximum load without and with the capacity-increasing effect should be reported.

For the punching shear capacity, the critical position of the loading vehicle or test tandem should be considered that results in the lowest punching shear capacity. The difference between the punching capacity with three or four sides needs to be explored, both for a single wheel print, two wheel prints (Figure 6), and the entire tandem. If a loading tandem is placed in the first lane, the punching perimeter with four sides should be compared to the punching perimeter with three sides (see Figure 7), and the smallest perimeter length should be used for the calculations. For slabs with a small thickness, such as the deck slabs of girder bridges, punching shear can be the governing failure mode. For these cases, the effect of compressive membrane action should be explored and the maximum loads without and with this capacity-increasing effect should be reported (Amir et al. 2016).

If models are available to evaluate the expected capacity of a certain bridge type, but these models are not reported in the codes, then the code-prescribed capacities as well as the capacity determined from the specific model should be determined, reported, and compared. For example, for reinforced concrete slab bridges, a plasticity-based model (the Extended Strip Model (Lantsoght et al. 2017d)) can be used to determine the maximum load that is expected to cause failure, considering the interaction between two-way flexure and one-way shear.

If during the preparation for a proof load test, discussion arises with regard to the maximum load that the bridge can carry and the expected failure mode, nonlinear finite element models can be used to explore the effect of different assumptions (Rijkswaterstaat 2017). However, it must be remarked that often the goal of a field test is to remove certain uncertainties that cannot be directly covered by analytical models. Whether or not it is cost-effective to develop a nonlinear finite element model as part of the preparation depends on the test objectives and the type of load test under preparation. After the test, this model can then be updated with the field observations, where extrapolations to higher load levels can be the outcome (Lantsoght et al. 2018).

The used theoretical evaluations should provide a support to the identification of the critical areas of the structure and serve as a method to estimate placing of the monitoring equipment as well as support safety measures when planning the bridge test.

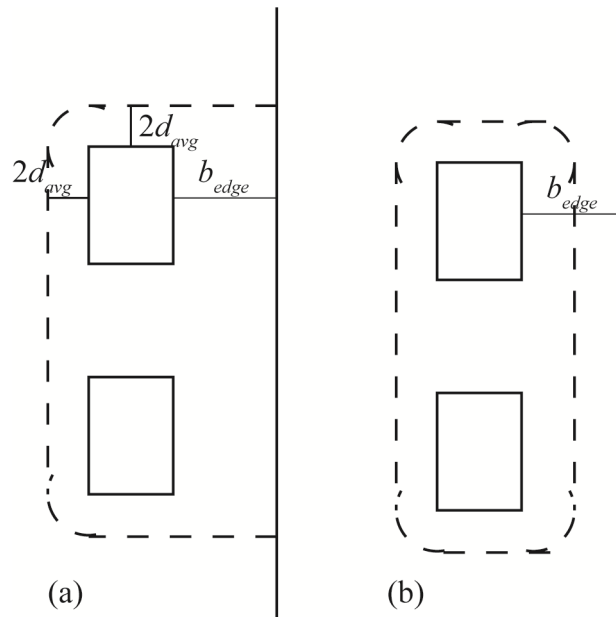

Figure 6. Punching of two wheels: (a) perimeter with three sides; (b) perimeter with four sides. d_{avg} is the average of the effective depths to the x- and y-direction flexural reinforcement, and b_{edge} is the edge distance.

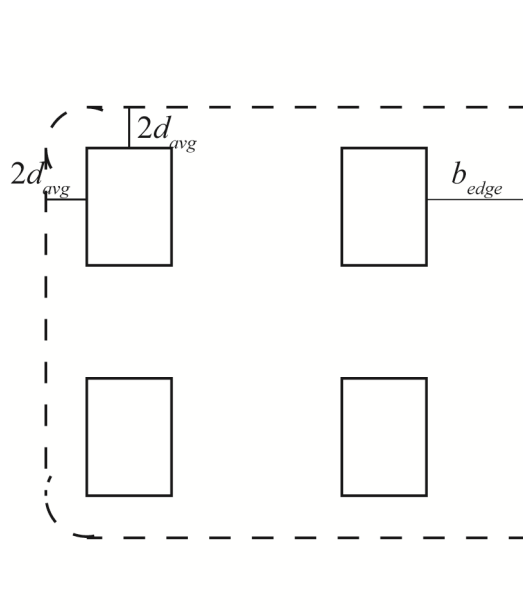

Figure 7. Punching of the entire tandem, showing perimeter with three sides. d_{avg} is the average of the effective depths to the x- and y-direction flexural reinforcement, and b_{edge} is the edge distance.

5 PLANNING AND PREPARATION OF LOAD TEST

5.1 Planning

To prepare for a successful execution of a load test, it is important to plan the on-site activities beforehand, as shown for example in Figure 8. All steps that form part of the load test on-site, such as applying the sensors, preparing the load, marking positions or driving paths, the actual load test, and then dismantling all equipment should be considered in this detailed planning. Examples of actions that can be included in the detailed planning can be:

- Collecting of sensors, wires, logging gear, and other required equipment.
- Verification of the bridge site closing time or related closing and rerouting schedule.
- Transportation of sensors, other required equipment, and personnel to the test site.
- If no scaffolding is constructed, it should be determined for which operations a manlift is necessary, which then will help to determine the required number of manlifts on site.
- Marking a grid on the structural members for reference. This grid may already be available from the detailed technical inspection, where it was used for drawing the map of damage and deterioration.
- Marking the positions of the sensors.
- Marking the critical positions of the wheel prints when jacks are used to apply the load, or the driving path when loading trucks are used to apply the load.
- Applying the sensors to their positions required during the test.
- Testing if the sensors are functioning correctly.
- Delivering the required loading equipment to the site, building the setup for applying the load, and applying the loading to its position as used during the test, when a system with jacks and counterweights is used.
- Coordination of bringing trucks, drivers, and weights to the test location, and weighing the trucks, when loading trucks are used.
- Execution of the load test according to a prescribed loading protocol.

- If another span is tested, changing the sensors to this span. If a test setup is built to apply the load, this setup should be moved to the next span that is to be tested as well.
- Removal of the loading equipment from the tested span and from the bridge site.
- Removal of the applied sensors.
- Transportation of sensors, other equipment, and personnel away from the test site.

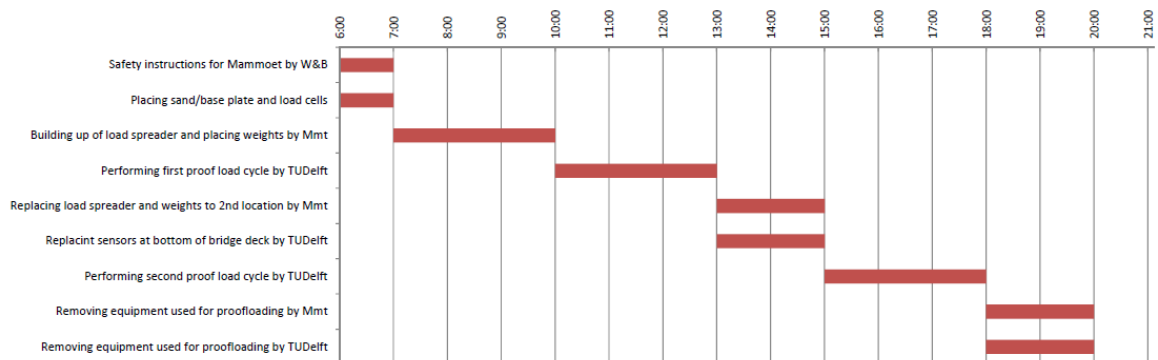

Figure 8. Example of time schedule for planning, showing one day.

It should be identified who will be responsible for which task, and which equipment is necessary. All potentially dangerous activities should be carried out by at least two individuals. Examples of such activities include handling of loading equipment, handling of ballast, applying measurement equipment from an elevated surface such as a ladder or in a manlift, hoisting, lifting, climbing, and activities close to water or moving traffic. The detailed planning is necessary for streamlining the activities on site, and should be discussed with all personnel that will be involved with these actions. This detailed planning can only be developed after the technical inspection, so that site limitations or changes to the structure can be accounted for.

An overall planning, outlining the larger actions that need to be carried out on site, should be prepared and included in the preparation report. In the general preparation for the load test, it must also be discussed with the owner of the bridge and/or client when a preparation report including the planning is expected, for how much time the bridge can be available for testing, and how much time after the test the final report should be delivered. It is good practice to deliver the preparation report including the planning to the bridge owner and/or client no later than five working days before the start of the activities on site. This report should also be communicated to all parties involved and should be accepted by all parties involved with the execution of the test.

5.2 Personnel requirements

Depending on the governing codes, there may be requirements stated with regard to the personnel. For example, ACI 437.2M-13 (ACI Committee 437 2013) requires that a licensed professional be responsible for the preparation of the load test and for decision-making on site during the test. The Manual for Bridge Rating through Load Testing (NCHRP 1998) stipulates that a qualified bridge engineer should be responsible for the planning and execution of the load test, and requires that the engineer has experience in testing and instrumentation, field investigations, and possesses adequate knowledge of bridge structural behavior. In addition, this manual requires that adequate staff be available to perform the load test, to provide traffic control during the test, and to assist in evaluating the results.

In most countries, current practice for the execution of load tests requires that the planning be developed by an engineer. During proof load tests, the stop criteria need to be checked by the responsible engineer based on real-time measurements (Figure 9). He/she needs to make the decision with regard to loading to the next load level, or he/she should decide that further loading could result in permanent damage to the structure, and that the test should be terminated prior to reaching the target proof load.

In addition to the requirements with regard to the responsible engineer, it is good practice to have one individual on site who is a certified safety engineer, and one individual who is trained in first-aid. As mentioned in §5.1, for all potentially dangerous activities, sufficient personnel should be present to be able to work safely. The required number of personnel, and their task division should be identified in the detailed planning. For the safety of the traveling public, personnel should be available to guide the traffic, or a detour should be determined and signposted.



Figure 9. Measurement engineers following measurements in real-time during a proof load test. Photo by M. Roossen, used with permission.

5.3 Loading requirements

The loading setup relates to the type of load test that will be carried out and its objectives. If a diagnostic load test will be carried out, the applied load should result in measureable responses, so that these responses can be used for comparison to and updating of the analytical model. If a proof load test will be carried out, the applied load should be representative of the factored load combination, so that it can be experimentally shown that the bridge fulfils the code requirements.

For a diagnostic load test, the magnitude of the load that results in measureable responses can only be determined after the technical inspection and preliminary calculations have been carried out. These preliminary calculations and the developed analytical model are necessary to determine the expected response under a certain magnitude of applied load. If the behavior is expected to change for different load levels, for example as a result of unintended composite action, the applied load should be representative of the heaviest service load. This load level is

then required to ensure that the measured responses and the updating of the analytical model are in line with the responses at the load level that governs for rating and assessment.

For a proof load test, the required target proof load and resulting loading requirements can also only be determined after the technical inspection and preliminary calculations. The analytical element model that is developed as part of the preliminary calculations will be used to identify the target proof load. This target proof load should represent the factored live load on the bridge, and the equivalence between the loads can be determined based on sectional moments or forces.

Depending on the type of test, different methods can be used for applying the load. The most common methods are:

- The use of dead weights that are applied to the bridge directly, Figure 10a.
- The use of a loading frame or other type of test setup and hydraulic jacks, Figure 10b.
- The use of test vehicles: dump trucks or specifically designed trucks for load tests, Figure 11.

Examples of the use of dead weights in a load tested building are shown in Figure 12 and Figure 13. Dead loads are more commonly used for load testing of buildings than for bridges.



(a)



(b)

Figure 10. Load application methods: (a) dead weights on bridge, and (b) application of loading rig with hydraulic jacks.



Figure 11. Load application with dump trucks.



Figure 12. Example of application of dead weight with water. Photograph by S. Camino. Printed with permission.



Figure 13. Example of application of dead weight with cement bags. Photograph by S. Camino. Printed with permission.

When a loading vehicle is used, the choice of the vehicle (in terms of axle layout and load capacity) should be based on the following considerations:

- The loading vehicle should be representative of the load used for the design of the bridge (for a new bridge) or the load used for the assessment of the bridge (for an existing bridge).
- If the bridge should be rated for permit vehicles, the loading vehicle should be representative of this load and vehicle type.

- The loading vehicle should be similar to the heavy vehicles that are expected to use the bridge (for new bridges) or that are using or will be using the bridge (for existing bridges) in terms of weight and axle configuration.
- The loading vehicle should be able to induce the critical state of stress in the element that needs to be verified- or evaluated.
- The loading vehicle should also be selected based on its availability within a reasonable distance from the testing site and based on practical considerations regarding the execution of the load application and associated costs.

Different controlling failure modes, as may be tested for in a proof load test, may require different vehicles. An example, showing a special load testing vehicle, is given in Figure 14

The loading requirements for proof load testing are stricter, as higher load levels are applied during proof load testing. The requirements then have, as their goal, to ensure a safe execution of the load test. To maintain structural safety during a proof load test, it is imperative that the load can be offloaded rapidly when large deformations occur, e.g. when a stop criterion is exceeded. As such, the application of dead load alone is not recommendable for proof load tests on bridges, as this loading method may result in collapse if the structure is weakened due to undesirable structural damage as well as large deformations. An added disadvantage of the use of dead load is that, when deflections occur in the tested structure, arching action can develop in the loads, resulting in effectively lower loading in the structure as the load is carried through the arch to the supports. This disadvantage can be mitigated by using water in soft basins as a load application method. When a system with hydraulic jacks and a loading frame is used, see Figure 10b and Figure 15, large deformations will result in the deactivation of the hydraulic jacks, so that the structure is not loaded anymore and the load of the applied counterweights is carried directly to the supports.

For proof load testing, a cyclic loading protocol with a number of load cycles for each load level is recommended, so that the stop criteria can be checked after each load cycle, and so that the linearity and reproducibility of the results can be checked after each load cycle. Therefore, a requirement to the loading method is that the loading protocol can be applied in the test. This protocol can be achieved with loading vehicles (Steffens et al. 2001, Bretschneider et al. 2012) and a loading frame with hydraulic jacks, see Figure 15. Moreover, to make sure that all loading cycles at the same load level are comparable, it is necessary that the applied loading is executed at a prescribed loading speed. This requirement can be achieved by using loading vehicles driving at a constant (crawl) speed, or by using hydraulic jacks with a prescribed loading speed.



Figure 14. Example of application of load with load testing vehicle. Photograph by D. Hordijk. Printed with permission.



Figure 15. Use of counterweights, steel spreader beam, and a single hydraulic jack.

5.4 Traffic control and safety

For all activities on site, all aspects of safety should be considered and checked for by the responsible safety engineer. All possibly hazardous situations and possible problems during the onsite activities should be reported in a risk analysis as part of the preparatory report. This analysis can only be carried out after the technical inspection of the bridge and bridge site, during which attention should be paid to the potentially hazardous situations. Possible problems that can occur during the activities on site should be considered, and a solution or back-up plan should be thought through before the test. Possible problems include mechanical failures, electrical and electronical failures, sickness of personnel, and external conditions such as bad weather conditions.

The specific tasks of the safety engineer depend on national practice and codes. In the Netherlands, the safety engineer is responsible for the safety card, the safety briefing, inspection of the on-site safety, and preparation of a report regarding safety for all parties involved prior to the test. The safety card gives a brief overview of the actions that need to be taken in case of an accident, fire, or other calamity, and contains the phone numbers and addresses of the emergency services, police, fire station, nearest hospital, nearest doctor, and nearest pharmacist. The safety briefing is required for all personnel prior to starting their on-site activities to review the basic safety principles and dangers related to working on site. For some projects, a safety certificate is required for all personnel involved.

During all onsite activities, the safety of the traveling public and possible local spectators should be safeguarded. The responsibility for the safety of the traveling public and local spectators lies with the parties executing the load test, not with the traveling public and local spectators themselves. A traffic control plan and, if the bridge is closed during the load test, a detour should be developed together with the local road authorities. An example of a temporary traffic situation during a load test is shown in Figure 16.



Figure 16. Overview of traffic situation during a load test. From left to right: one lane open for traffic, one lane used for load testing, temporary bike bridge. Photograph by S. Fennis. Printed with permission.

The last aspect of safety that should be ensured during all onsite activities is the structural safety. For this purpose, thorough preparations of the load test are recommended, together with adequate instrumentation of the structure. Since load tests are sometimes used to answer questions with regard to behavior of the structure, the thorough preparations prior to the test can sometimes only give an indication of the expected behavior. For this reason, varying possible effects (restraint at bearings, unintended composite action...) in the finite element models during the preparation stage can give a possible range of expected responses. To make sure the responses during the test lie within the expected range, or to find an explanation for responses that lie outside of this range, the responses should be measured. Extensive finite element models prior to load tests are not always cost-effective and the decision with regard to modeling depends on the bridge type and test objectives. When such calculations are not carried out, the measurements become even more important. The sensor output should be followed and evaluated during the load test. For proof load testing the measured responses also serve the purpose of verifying the stop criteria. As such, the development of the sensor plan is a part of the preparations for the test and the preparations to ensure the safety during the test.

5.5 Measurements and sensor plan

An important part of the preparation for a load test is the development of the sensor plan, which should show the position, type (Ettouney and Alampalli 2012), and range of the selected sen-

sors, and give insight in the data collection scheme by including the data logger type, sampling rates, test controls, data transmission means, as well as the mounting and wiring details, where relevant. An example sensor plan (not showing the data collection system and wiring details) is given in Figure 17. The preparation report should also include a detailed list explaining the requirements per sensor and a justification for its inclusion in the sensor plan.

The first step in developing a sensor plan is to select the suitable sensors. The required range of the sensors should be selected based on the preliminary calculations. For materials with time-dependent behavior such as concrete, the effect of time-dependent behavior on the responses should be considered. For concrete, the structural response also differs depending on whether the cross-section is uncracked or cracked. An extra margin for the structural responses should be taken into consideration, so that no sensor runs out of its measurement range when larger structural responses than expected occur during the test. Moreover, the accuracy of the sensor or chosen measurement technique should be sufficient for the load test. Where small variations may be critical, the selected sensor should be able to capture these responses. Additionally, the sampling rate of the sensor or selected measurement technique (when this sensor or technique is digital) should be selected taking the loading speed and expected speed of change in responses in consideration (i.e. for dynamic load testing, a faster sampling speed is required than for a static load test with a monotonic loading protocol during which the load is kept constant for 24 hours). All sensors should be calibrated before each load test, and their correct conversion factors should be updated in the data logging and visualization software. Finally, all deployed sensors should be suitable for field testing and outdoors conditions and their operation should be affected as little as possible by (changes in) the environmental conditions (often monitoring equipment is developed for laboratory conditions). Examples of limitations to sensors in field conditions include difficulties with laser sensors during rain (the rain drops reflect the laser beam), as well challenges using photogrammetry and DIC calibration when the camera lens fogs over or when there is limited daylight.. Besides the possible effects of temperature and humidity, which will be discussed later in this section, the proper functioning of the sensor should depend as little as possible on the environmental conditions. Any external influence in the sensor results should be justified and quantified in regards to the precision before test initiation.

A requirement for the data acquisition equipment is that its sampling rate should correspond to the loading speed and expected speed of change in responses. When the structural responses should be followed in real-time during the experiment, analog to digital conversion and data analysis software should be present and running during the experiment. For proof load testing, the structural responses must always be followed in real-time, so that the stop criteria can be checked.

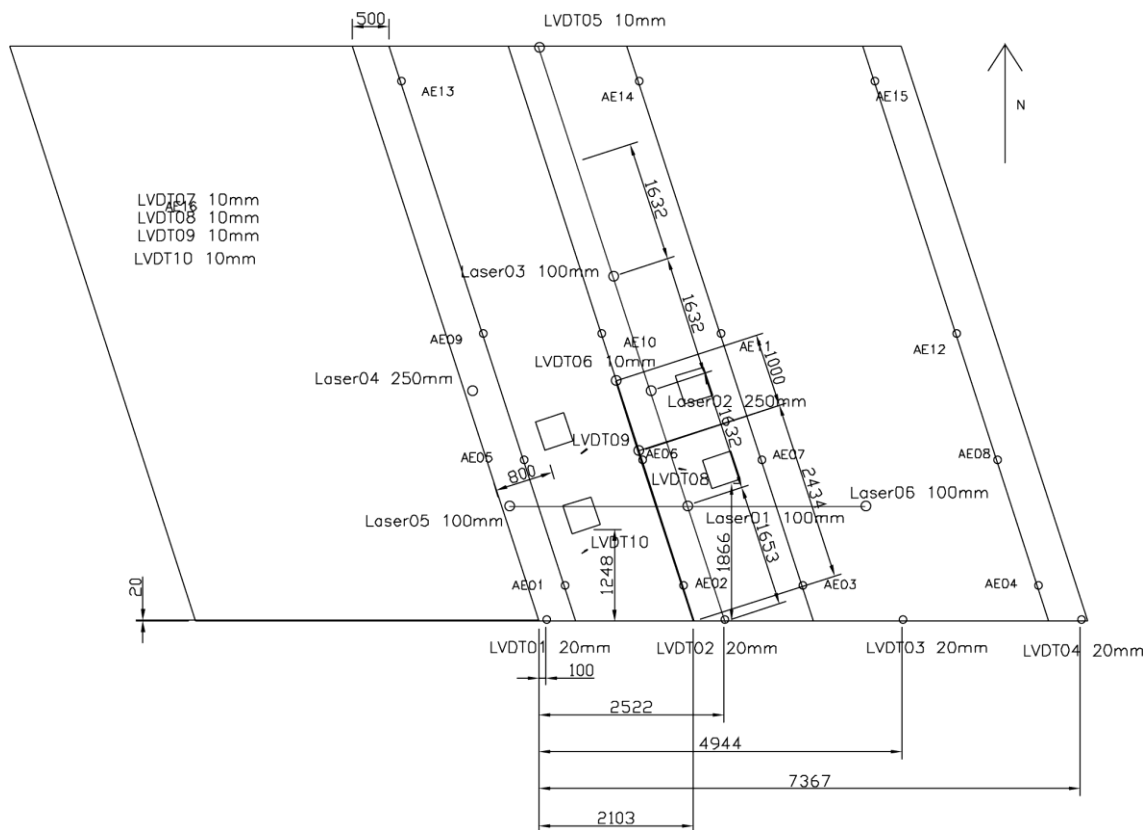

Figure 17. Example of sensor plan, showing position of loading tandem, position and range of lasers and LVDTs to determine deflection profiles, acoustic emissions sensors and additional LVDTs for monitoring crack width of cracks that are selected on site. Modified from (Lantsoght et al. 2017e).

The sensor plan should be developed in such a way that the critical structural responses can be followed during the load test, and so that the required information about the structural behavior can be gathered during the test. The sensor plan should be developed keeping in mind the requirements for monitoring during the test and the required information to meet the objectives of the test for the analysis afterwards. For a diagnostic load, the measurements are followed during the test to check if the structural responses are within the expected range, and the responses are used after the test to update the analytical model that was used for design or assessment of the bridge. For a proof load test, the measurements are followed during the test to check if the structural responses are within the expected range, and to verify if no irreversible damage occurs. The latter criterion is expressed based on the stop criteria. These stop criteria need to be determined prior to the proof load test, and the acceptable threshold values, determined based on the expected failure mode and preliminary calculations, should be agreed upon prior to the test.

Parameters that are typically measured during a load test are:

Local measurements:

- The linear strains at locations of interest can be measured. For example, for concrete bridges the strain on the bottom of the cross-section can be followed for the verification of the stop criteria, for steel girder bridges the longitudinal strain on the bottom surface at mid span can be monitored to follow the maximum strains when loading trucks drive over the bridge, the strains can be determined over the height of the girder to find the position of the neutral axis and evaluate if unintended composite action occurs, or strains in the transverse direction can be used to find the transverse distribution.

Exterior and global measurements:

- The deflections at a number of positions or at the critical position can be measured. When only the critical position is measured, the load-displacement diagram can be analyzed, which gives an idea of the overall stiffness of the structure and may indicate the onset of nonlinear behavior. When the deflections at a number of positions are measured, the deflection profiles in the longitudinal and/or transverse directions can be developed. These profiles give an indication of the overall structural behavior, onset of nonlinear behavior, (re)distribution, settlements etc.
- The surface deformations can be monitored to estimate strains over a certain length or surface or to cover cracking over a certain length or surface.
- The rotations at the supports can be measured, to get an idea of the real boundary conditions at the supports. As such, these measurements can give an idea of the restraint magnitude occurring in joints and/or bearings.
- For concrete bridges, existing cracks can be monitored during the test and the opening and closing of the crack during the test can be measured. If a selected critical crack is monitored, there may be discussion about the selection of this crack. A solution to this problem is the use of non-contact measurements that can follow all cracks in a predetermined area.
- In dynamic load tests, it is necessary to measure accelerations.
- The reference strains outside the loaded member/span can be monitored to measure the effect of temperature and humidity and find the net structural response.
- The compression of the supports for bridges with elastomeric bearings should be measured to find the net deflections.

- The settlements of the substructure need to be monitored when significant settlements are expected and/or a stop criterion regarding the substructure is defined.
- The compression and expansion at the joints needs to be monitored when limited space in the joints is observed during the technical inspection.
- The environmental conditions during the test should be measured: The ambient temperature, wind speed (if relevant), and humidity during the test. Additionally, the surface temperature of the bridge at relevant positions can be measured.

Interior measurements

- Acoustic emissions (see Figure 18) can be monitored during load testing, to get information about changes in structural behavior before these changes can be observed with the bare eye, such as for concrete cracking.
- Optical fibers provide a promising strain measurement method. These sensors can be cast into the structure during casting of concrete or adhesively bonded into a surface slit on existing bridges. They can cover larger distances than traditional localized strain measurements.

When critical situations or elements were determined during the inspection as part of the preparatory stage, the corresponding structural response should be measured during the load test, and the acceptable threshold values should be determined prior to the load test. Depending on the goals of the load test and the type of critical situation or element, the responses should be monitored in real time during the test, or checked visually during the test at certain time intervals.



Figure 18. Application of acoustic emissions sensors. Photograph by Y. Yang, used with permission.

The effect of the ambient conditions on the sensors during a load test should be taken into account. Changes in temperature and humidity affect the measured structural responses in two ways:

1. The measured structural response includes the structural response due to the changes in temperature and humidity.
2. The sensor may behave differently when the ambient conditions change, which can result in unwanted or erroneous measurements.

For the first case, the net structural response due to the applied load should be filtered out and used for the analysis of the test. The structural response due to changes in temperature and humidity should be subtracted from the measured output. For this purpose, sensors can be applied outside of the tested region, so that only the effect of changes in temperature and humidity be measured. An example of such a reference sensor, as part of a sensor plan, is shown in Figure 19. Another solution would be taking measurements for a certain amount of time prior to the load application, to follow the structural responses as a function of the changing ambient conditions (Zhou et al. 2007). However, if the bridge is open to traffic and traffic is busy throughout the day, a clean registration of the baseline response will be difficult. For the second case, the inherent error in the sensor due to changes in temperature and humidity, the provided documen-

tation of the sensor fabricator should be consulted. For strain gages in particular, temperature-compensating gages may be used.

The magnitude of the effect of temperature and humidity on the structural members that are tested and on the sensors depends on the conditions of the load test. If the test is short in duration and carried out during the night, the effect will be smaller than when the test duration is longer and carried out during a sunny day, when the temperatures rise steadily.

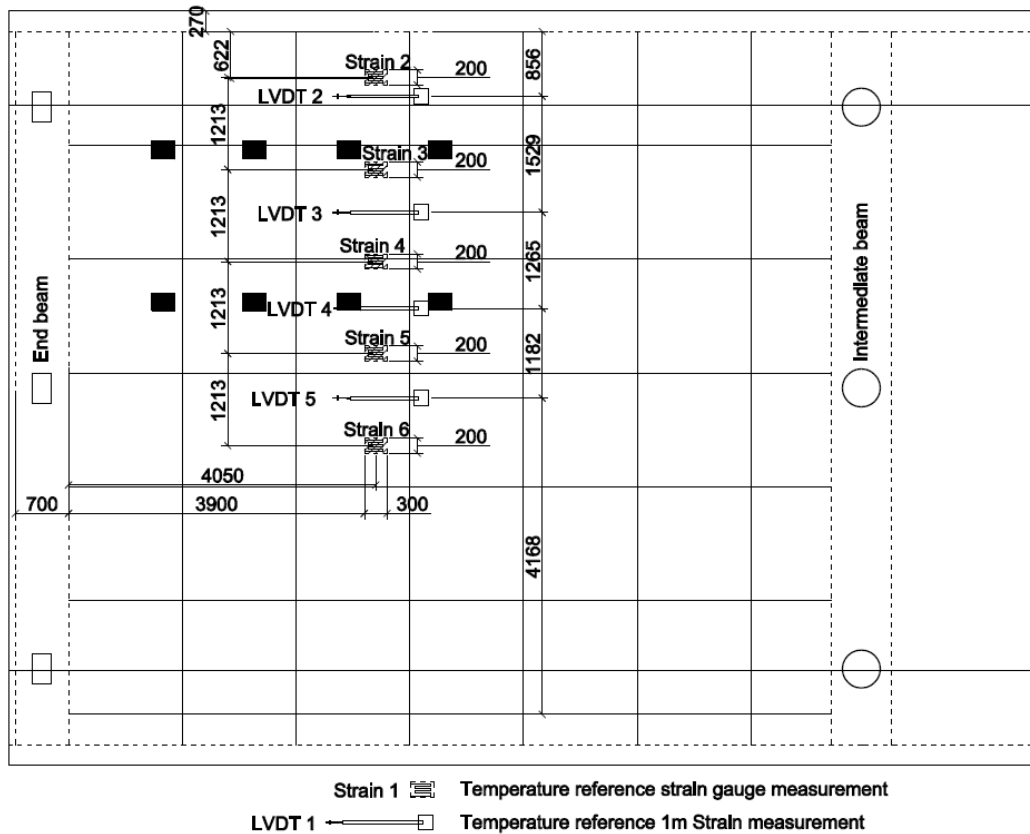

Figure 19. Example sensor plan, indicating LVDT1 as a reference strain measurement to compensate for the effects of temperature and humidity on the strain measurements.

When all sensors are selected, the sensor plan can be developed. Since the particularities for developing a sensor plan for a diagnostic load test and a proof load test are quite different, this section focuses on the general requirements to the measurements and sensors, whereas Part III gives guidance for the development of a sensor plan for a diagnostic load test and Part IV for a proof load test. The sensor plan can only be developed after the technical inspection of the bridge and its location. Site limitations or restrictions to the site access may prohibit the application of certain sensor types or positions. In some cases where access is severely restricted, only non-contact sensors may be applied.

In general terms, a sensor plan contains or can contain the following information:

- type, position, and range of all sensors that will be applied,
- additional sensors with type and range of which the position will be applied in the field (for example, for monitoring crack width in concrete bridges),
- number, type, and range of back-up sensors that need to be taken to the field,
- the required elements for data acquisition and real-time monitoring: data logger (and list identifying which sensor is connected to which canal), amplifier, analog-to-digital converter, data visualization software,
- the properties of the different data acquisition and visualization elements, including the sampling rates,
- a list with calibration values of all sensors and the date of the most recent calibration,
- details of sensor mounting for contact sensors,
- wiring details for wired sensors.

6 SUMMARY AND CONCLUSIONS

This chapter discussed the preparatory steps that are required prior to a load test to ensure the safety during the test and an efficient use of time on site. It is good practice to report the observations, choices, and calculations that were carried out during the preparation stage in a report that should be communicated to the bridge owner and/or client prior to the start of the on site activities, as well as to all parties involved.

Typically, the preparatory report summarizes the following elements:

- Statement of the test objectives, and a discussion of how these objectives will be met with the load test,
- Observations from the technical inspection of the bridge, documented with photographs and summarized in maps of deterioration and damage. If there are limitations on the test site with regard to the application of sensors or the load, and when possibly hazardous situations are observed, these should be reported as well. Critical structural elements or conditions observed during the inspection that should be monitored during the test should be discussed and documented as well.

- Preliminary calculations to prepare for the test: a summary of the design calculations for new bridges and assessment calculations for existing bridges, and a prediction of the expected structural responses during the test.
- An overview of the decisions with regard to the practical aspects during the load test: planning, personnel requirements, loading requirements, regulations with regard to safety, traffic control, sensor plan, and data acquisition and visualization requirements.

The test objectives determine in the first place if a load test is the correct method for meeting the objectives. Once it is decided that a load test is the right means to meet the objectives, and the type of load test is determined, the specific goals for the test should be identified. These goals are the basis for determining how the test will be carried out, what will be measured, and which post-processing and analysis is required.

Before any calculations and planning can be done, a technical visit to and inspection of the bridge and the bridge site should be carried out. This inspection is the first step in preparing for the test. The condition of the bridge should be evaluated and reported, and the site limitations that may affect the way in which the load test is executed should be documented and considered for the following calculations.

To prepare for the load test, preliminary calculations should be carried out. Depending on the test objectives, uncertainties, and available time, a finite element model of the bridge can be used for these calculations. It should be evaluated if a finite element model is cost-effective for the project. For new bridges, such models can be available from the design calculations. For existing bridges, such models can be built taking into account the material deterioration (resulting for example in section losses) and restraints at the supports. The assessment calculations can then be carried out based on these models. Then, the expected structural response during the experiment should be determined by using average (measured) material parameters and omitting all load and resistance factors. Where available, methods that have been developed based on laboratory experiments can be used to give a refined prediction of the expected behavior. When the uncertainties on the structure are large, the structural response for ranges of parameters with uncertainties can be explored. The expected behavior is required to determine the positions where the structural responses should be measured during the test, and the expected magnitude of the response, so that a suitable sensor type can be selected.

Once the condition of the bridge and site are known, and the expected behavior is calculated, the practical preparations can be carried out. A detailed planning of all activities on site is nec-

essary to streamline the activities. The required personnel, their qualifications, and assigned tasks during the test should be considered. Depending on the objectives of the test, the loading requirements can be determined. The method of load application should be determined (dead load, trucks, hydraulic jacks in a loading frame), and the critical position or wheel path during the test should be determined and reported on drawings. The safety of the bridge, personnel, and traveling public should be considered during the preparation stage. Where necessary, detours should be coordinated with the local road authority. Based on the goals of the test and the expected responses, the adequate sensor type, range, and sampling rate, sensor location, wiring, mounting, data acquisition, and data visualization (when required) should be selected. After this selection, a drawing showing these details, called the sensor plan, should be developed and added to the report.

REFERENCES

- AASHTO 2015. *AASHTO LRFD bridge design specifications, 7th edition with 2015 interim specifications*, Washington, DC, American Association of State Highway and Transportation Officials.
- AASHTO 2016. *The manual for bridge evaluation with 2016 interim revisions*, Washington, D.C., American Association of State Highway and Transportation Officials.
- ACI COMMITTEE 342 2016. ACI 342R-16: Report on Flexural Live Load Distribution Methods for Evaluating Existing Bridges. Farmington Hills, Michigan: American Concrete Institute.
- ACI COMMITTEE 437 2013. Code Requirements for Load Testing of Existing Concrete Structures (ACI 437.2M-13) and Commentary Farmington Hills, MA.
- AMIR, S., VAN DER VEEN, C., WALRAVEN, J. C. & DE BOER, A. 2016. Experiments on Punching Shear Behavior of Prestressed Concrete Bridge Decks. *ACI Structural Journal*, 113, 627-636.
- BRETSCHNEIDER, N., FIEDLER, L., KAPPAHN, G. & SLOWIK, V. 2012. Technical possibilities for load tests of concrete and masonry bridges. *Bautechnik*, 89, 102-110 (in German).
- CEN 2003. Eurocode 1: Actions on structures - Part 2: Traffic loads on bridges, NEN-EN 1991-2:2003. Brussels, Belgium: Comité Européen de Normalisation.
- ETTOUNEY, M. & ALAMPALLI, S. 2012. *Infrastructure health in civil engineering*, Boca Raton, FL, CRC Press.
- FENNIS, S. A. A. M., VAN HEMERT, P., HORDIJK, D. & DE BOER, A. 2014. Proof loading Vlijmen-Oost; Research on assessment method for existing structures (in Dutch). *Cement*, 5, 40-45.

- FIB 2012. *Model code 2010: final draft*, Lausanne, International Federation for Structural Concrete.
- KOEKKOEK, R. T., YANG, Y., FENNIS, S. A. A. M. & HORDIJK, D. A. 2015. Assessment of Viaduct Vlijmen Oost by Proof Loading. Stevin Report Nr. 25.5-15-10. Delft University of Technology. Delft, the Netherlands.
- LANTSOGHT, E., VAN DER VEEN, C., HORDIJK, D. & DE BOER, A. 2017a. Recommendations for proof load testing of reinforced concrete slab bridges. *39th IABSE Symposium - Engineering the Future*. Vancouver, Canada.
- LANTSOGHT, E. O. L., DE BOER, A. & VAN DER VEEN, C. 2017b. Distribution of peak shear stress in finite element models of reinforced concrete slabs. *Engineering Structures*, 148, 571-583.
- LANTSOGHT, E. O. L., DE BOER, A. & VAN DER VEEN, C. 2017c. Levels of Approximation for the shear assessment of reinforced concrete slab bridges. *Structural Concrete*, 18, 143-152.
- LANTSOGHT, E. O. L., DE BOER, A., VAN DER VEEN, C. & HORDIJK, D. A. 2018. Modelling of the proof load test on viaduct De Beek. *Euro-C*. Austria.
- LANTSOGHT, E. O. L., VAN DER VEEN, C., DE BOER, A. & ALEXANDER, S. D. B. 2017d. Extended Strip Model for Slabs under Concentrated Loads. *ACI Structural Journal*, 114, 565-574.
- LANTSOGHT, E. O. L., VAN DER VEEN, C., DE BOER, A. & HORDIJK, D. A. 2017e. Collapse test and moment capacity of the Ruytenschildt Reinforced Concrete Slab Bridge *Structure and Infrastructure Engineering*, 13, 1130-1145.
- LANTSOGHT, E. O. L., VAN DER VEEN, C., WALRAVEN, J. C. & DE BOER, A. 2016. Case Study on Aggregate Interlock Capacity for the Shear Assessment of Cracked Reinforced-Concrete Bridge Cross Sections. *Journal of Bridge Engineering*, 21, 04016004-1-10.
- NCHRP 1998. Manual for Bridge Rating through Load Testing. Washington, DC.
- RIJKSWATERSTAAT 2017. Guidelines for Nonlinear Finite Element Analysis of Concrete Structures.
- RYAN, T. W., MANN, E., E., Z., CHILL, M. & OTT, B. T. 2012. Bridge Inspector's Reference Manual. *In: US DEPARTMENT OF TRANSPORTATION, F. H. A. (ed.)*.
- SHU, J., PLOS, M., ZANDI, K. & LUNDGREN, K. 2015. A Multi-level Structural Assessment Proposal for Reinforced Concrete Bridge Deck Slabs. *Nordic Concrete Research*, 53-56.
- STEFFENS, K., OPITZ, H., QUADE, J. & SCHWESINGER, P. 2001. The loading truck BELFA for loading tests on concrete bridges and sewers (in German). *Bautechnik*, 78, 391-397.
- ZHOU, Y. E., CUPPLES, T. H., BROWN, R. & HWANG, G. 2007. Re-evaluation of Weight Limits for Six Bridges in Montgomery County Maryland. *IBC 2007*.

