

Mind your thoughts

BCI using single EEG electrode

Narayana, Sujay; Venkatesha Prasad, RangaRao; Warmerdam, Kevin

DOI

[10.1049/iet-cps.2018.5059](https://doi.org/10.1049/iet-cps.2018.5059)

Publication date

2019

Document Version

Final published version

Published in

IET Cyber-Physical Systems: Theory and Applications

Citation (APA)

Narayana, S., Venkatesha Prasad, R., & Warmerdam, K. (2019). Mind your thoughts: BCI using single EEG electrode. *IET Cyber-Physical Systems: Theory and Applications*, 4(2), 164-172. <https://doi.org/10.1049/iet-cps.2018.5059>

Important note

To cite this publication, please use the final published version (if applicable). Please check the document version above.

Copyright

Other than for strictly personal use, it is not permitted to download, forward or distribute the text or part of it, without the consent of the author(s) and/or copyright holder(s), unless the work is under an open content license such as Creative Commons.

Takedown policy

Please contact us and provide details if you believe this document breaches copyrights. We will remove access to the work immediately and investigate your claim.

Mind your thoughts: BCI using single EEG electrode

ISSN 2398-3396

Received on 25th August 2018

Revised 12th November 2018

Accepted on 22nd November 2018

E-First on 15th February 2019

doi: 10.1049/iet-cps.2018.5059

www.ietdl.org

 Sujay Narayana¹ ✉, RangaRao Venkatesha Prasad¹, Kevin Warmerdam¹
¹Embedded Software Department, Delft University of Technology, The Netherlands

 ✉ E-mail: sujay.narayana@tudelft.nl

Abstract: These days, the Internet of things (IoT) research is driving large-scale development and deployment of many innovative applications. IoT has indeed brought many smart applications to the doorstep of users. IoT has also made it possible to connect many sensors and control equipment. Here, the authors address an important application for physically challenged. The authors present a brain-computer interface (BCI) system to lock/unlock a wheelchair and control its movements using BCI. The approach presented here uses NeuroSky's MindWave Mobile, a single electrode electroencephalography (EEG) headset that can be connected to any Bluetooth-enabled system. The raw EEG data from the headset is processed on an Android mobile device to extract the electromyography (EMG) patterns that occur due to eye blinks and activity of muscles in the jaw. These patterns are used to control the movement of a wheelchair in all possible directions. A biometric security system is provided to lock and unlock the wheelchair by extracting the information about different brain waves from the raw EEG signal. In this system, only the user knows the password which is generated using brain waves and it can lock/unlock the wheelchair and control it. The proposed system was verified and evaluated using a prototype.

1 Introduction

In the recent years, brain-computer interface (BCI) has become more accessible to communicate with machines. Usually, electroencephalography (EEG) is used in BCI. Conventional EEG-based systems require a network of large set of electrodes, monitoring multiple points around the head. In particular, with a large number of electrodes, hitherto, the main focus of BCI is related to medical research, where brain activities are studied to diagnose the mental diseases. It is also used as diagnostic, and to some extent, in curing too. BCI technology has shed light on many medical support systems where a paralysed person can move using brain-controlled wheelchairs. BCIs are used in treating several neurological or psychiatric diseases such as Alzheimer's disease, where patients in the advanced stages lose the ability to communicate verbally. BCI systems allow these patients to convey their basic thoughts and emotions in terms of 'yes' or 'no'. Industries like Intel are exploring innovative ways to develop and introduce new BCI systems that can be a boon to the future society.

Apart from medical applications, some prototypes have demonstrated the possibility of introducing BCI in the area of entertainment. This approach includes applications like BCI 'painting' system where a physically disabled patient can get the pleasure of painting without using hands [1]. BCI games have also been used to stimulate mental exercises. In the context of Internet of things (IoT), there are a few simple applications, such as identifying brain activity when an object is touched [2], game play [3], robot navigation [4, 5], child educator [6], personal career plan [7], control of prosthetics, vision analysis etc. Companies like NeuroSky, Emotiv, and others offer developer tools and headsets which can be wirelessly connected. However, these devices use single dry sensor compared to that of medical systems, which predominantly use multiple electrodes with wet sensors for precision measurements.

For large-scale use of BCI systems in daily life, it is important to have sensors that are simple to use. Here, the *first* challenge is to get useful command and control with fewer sensors (preferably single) unlike the multiple wet electrodes used in medical systems. While a single electrode and its placement limit the potential applications of such devices, they are inexpensive and offers ease of use. For complex analysis of the different classes of neural

oscillations, it should be noted that movements in the head such as blinking are strongly detectable through such a sensor along with EEG signals. The responsiveness of the signals originating from muscular movements, called electromyography (EMG), is superior. Within the broader system, the latter can be used to control the wheelchair, while the former can be used for biometric security.

The voltage level of electrical signals generated by brain cells is very less compared to that of muscle cells. Hence, the muscle movement such as eye blinking, tensing the jaw etc. generates signals with higher voltage when compared with that of brain cells. Yet, in both the cases, the output signal is in the range of few microvolts. Therefore, the output from EEG sensors is amplified to boost the signal and to convert them to digital; however, in the process, the noise is also equally amplified. Consequently, the traditional method of identifying the peak amplitudes in the EEG signal [8] is not fruitful if the muscular activity is to be detected. Now, the *second* challenge is to get the meaning out of such signals.

The approach presented in this paper goes beyond the conventional method of detecting muscular activity such as jaw tension or eye blinks by peak detection. We propose novel signal conditioning methods to detect multiple activities (in turn they can be used as commands). This work proposes a method of interpreting the EEG signal produced by an off-the-shelf BCI headset. In our experiments, we used NeuroSky's MindWave Mobile [9], which has a single electrode. This headset is comparatively inexpensive and communicates wirelessly via Bluetooth. The *third* challenge is to make this system universally usable, i.e. to make it lightweight so as to execute on a mobile device. It also makes it easy to connect to the Internet. Once the signals are interpreted, it can be used to control any other connected devices. As an example, we demonstrate both controls of a miniature electric wheelchair and also we secure it from being used by others. The contributions of this work include:

- i. We propose lightweight signal processing algorithms to get the meaning out of raw EEG data rather than signals derived from the EEG headset.
- ii. We blend EEG and EMG signals and demonstrate controlling of different devices and applications.

- iii. We propose a method for identifying mental tasks, where an individual is in attentive state, meditation state and neutral states (relaxed state, not doing any work) are distinguished.
- iv. A biometric identification system is proposed using EEG signals to lock and unlock the wheelchair to secure it from being used by others.
- v. The movement control of a wheelchair in all possible directions is accomplished by interpreting jaw tension and eye blinking through the analysis of EMG signals.

An important aspect is that the signals are of very low frequency in terms of a few hertz. Therefore, the task of processing such signals is highly challenging.

The rest of this article is structured as follows. In Section 2, we provide state of the art in the field of BCI. In Section 3, we explain the basic principle behind the operation of BCI and different classifications of brain waves. In Section 4, novel methods are presented for the extraction of information from EEG and EMG signals in order to distinguish different commands. Experimental set-up and the evaluation of the system are described in Sections 5 and 6. Finally, we conclude in Section 7.

2 Related work

Online classification of two mental tasks using a support vector machine (SVM)-based BCI system is dealt in [10]. In this approach, signals are registered using 16 electrodes. They are differentiated using an SVM-based classifier in order to control a robotic arm in a two-dimensional space. Hal *et al.* [11] presented a real-time sleep detection system using a NeuroSky MindSet. Here, the EEG signal from a single, dry sensor is filtered into different EEG frequency bands and analysed to indicate the onset of sleep. An EEG-based eye blink detection system for BCI is reported in [8] by identifying the voltage peaks which are generated during eye blink. Campisi and Rocca [12] address several techniques for an automatic user recognition system based on the analysis of brain activity in real-life applications.

Huang *et al.* [13] proposed the fastest BCI called 'fast Phonics-to-Chinese-Character system' for individuals to write Chinese characters using his/her brain waves. They developed a novel spelling system for writing Chinese characters using both P300 and N200 spelling systems. BCI with EEG signals for automatic vowel recognition based on articulation mode is implemented in [14]. The approach consists of using brain signals while thinking of a specific task corresponding to vowels. A BCI classifier for wheelchair commands using the neural network with fuzzy particle swarm optimisation is dealt in [15]. They present a classification of three mental tasks based on BCI that uses the Hilbert–Huang transformation for extracting features from brain waves. These features are then used to control a wheelchair and composing words. A design of BCI system for piloting a wheelchair using five classes of motor imagery-based EEG is presented in [16]. Where EEG signals are analysed using wavelet transform and then features are extracted. These features are classified using SVM to control the directional movement of a wheelchair. A navigation system using brain waves to control a robot is addressed in [4]. Here, the system is tested with two headsets, one from NeuroSky and one from Emotiv. However, they do not process the raw signals from the headsets. Instead, they use the processed signals provided by these prototypes. Eid and Fernandes [17] present a BCI system that reminds readers when they are not focusing on the text. They use NeuroSky MindWave headset to measure the attention level of readers and combine the measurement with visual-based information. They make use of the processed EEG signal values for reading attention and meditation levels provided by the headset.

As we see in the literature, more focus is on BCI systems using multiple electrodes. Many of the single electrode experiments reported to use NeuroSky headset, but they all use the processed attention and meditation levels provided by the vendor. The work presented in this paper goes beyond the conventional use of NeuroSky MindWave headset by exploiting the raw EEG signals from the electrode instead of using the blink details or the attention and meditation levels given directly by the headset. Moreover, we

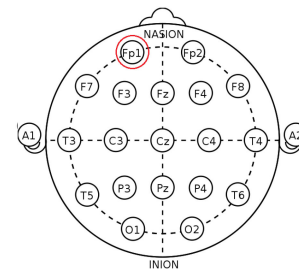

Fig. 1 Ten to 20 electrode placement system (http://commons.wikimedia.org/wiki/File:21_electrodes_of_International_10-20_system_for_EEG.svg)

demonstrate how a BCI system can be used in the field of biometric security, a scarcely represented topic in the BCI-related literature. In the subsequent section, we describe BCI and the methodology used.

3 Neural oscillation

The brain communicates with different parts of the body by sending electrical signals via neurons. Hence, there is a concentration of electromagnetic signals in and around the brain. The amplitude of these signals is very low (a few microvolts), yet measurable. The EEG sensors placed on the head can detect different electrical signals corresponding to the brain activity. There are two types of EEG electrodes, *viz.* invasive – where the sensors are placed inside the skull by surgery to measure the electrical impulses; and non-invasive – where the electrodes are placed on the head and touch the scalp to measure the signals. Non-invasive electrodes produce poor signal resolution as the skull dampens electromagnetic signals. Non-invasive type electrodes are further classified into active (wet) electrodes and passive (dry) electrodes. Wet electrodes make use of a conducting gel applied between the scalp and the electrode for a better conduction of signals. Dry electrodes are worn without this, similar to the way a hair band or a cap is worn.

3.1 Electrode placement

For analysing the brain's activities, the brain is divided into four parts or lobes and each of them is responsible for a specific task performed by the brain. The frontal lobe is responsible for making judgements, like controlling some motor functions. The parietal (top) lobe is involved in sensory functions, like visual attention. The occipital (back) lobe controls the interpretation of the vision. Lastly, the temporal (bottom middle) lobe governs hearing, smell, and short-term memory. When a certain task is performed by the brain, the electrical signals related to respective tasks are concentrated in the corresponding lobe. To get consistent readings from a specific region of the head for a specific task, a standard '10–20 system' is used, where non-invasive electrodes are placed accurately. The 10–20 system is an internationally recognised system that specifies the physical distances between the adjacent electrodes placed on the head. The numbers 10 and 20 refer to distances used in terms of percentage of the total distance between the *nasion* and *inion* as shown in Fig. 1. Here, the markers **F**, **Fp**, **C**, **T**, and **O** stand for frontal, pre-frontal, central, parietal, temporal, and occipital positions, respectively. The other electrodes are placed at similar fractional distances. NeuroSky's MindWave Mobile uses a passive type EEG sensor with one electrode that rests on the forehead above the left eye, or the Fp1 position, to measure the signal from the frontal lobe. The MindWave headset is shown in Fig. 2. The ground reference for the electrode is taken from the A1 position using an ear clip.

3.2 Distinct waves

Neural oscillations measured by EEG can be characterised by their frequency, amplitude, and phase. These properties change when the tasks performed by the brain change. Neural waves are most generally classified as [18, 19]; we reproduce them for the sake of



Fig. 2 Neurosky mindwave mobile EEG headset

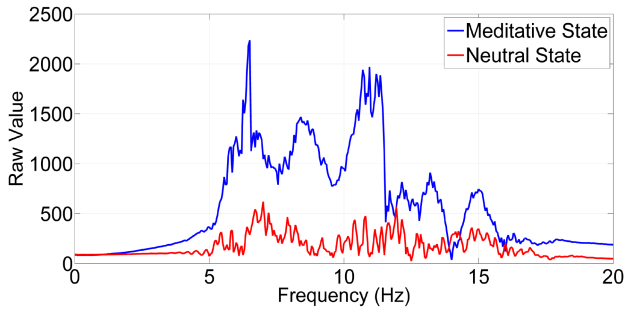

Fig. 3 Alpha activity, transitioning from meditative to neutral state

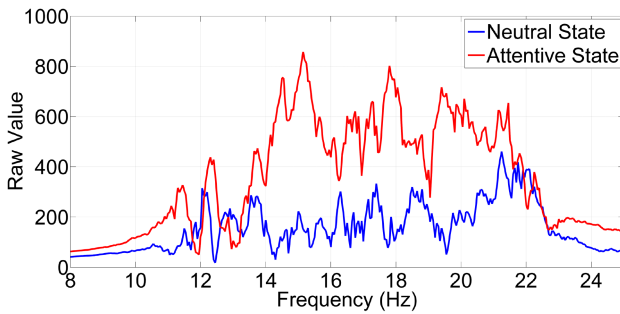

Fig. 4 Beta activity, transitioning from neutral to attentive state

completeness: (i) delta waves (1–4 Hz) are a low-frequency signals generated in the brain when the person is in deep dreamless sleep; (ii) theta waves (4–8 Hz) can be seen during dreams and in deep state of meditation; (iii) alpha waves (8–13 Hz) are dominant in a relaxed state like visualisation and meditation; (iv) beta waves (13–30 Hz) are generated usually in working state, especially when the person is attentive, applying logic, anxious, or stressed; and (v) gamma waves (30–70 Hz) are high-frequency waves in the EEG signal. They can be seen in states of peak performance, both physical and mental, during high focus and concentration. These signal properties can be extracted from neural recordings using frequency-domain analysis. Activities in the brain can be detected from wave patterns in the corresponding frequency bands.

4 Signal processing

In our work, we concentrate on the meditative and attentive states of the brain, identified using alpha and beta waves, respectively. By switching between these states, a biometric password is created that can be used to lock/unlock an electronic system. Once the system is unlocked, we make use of EMG signals created by eye blinks and jaw tensions to command (such as moving a wheel chair front, back) the system. In this section, we first explain how the EEG pattern is recognised and how the different states (alpha and beta waves) are classified, and then EMG pattern recognition for eye blink and jaw tension detection.

4.1 EEG pattern recognition

The first step in recognising a brain state is to acquire the signal from the sensor and filter the noise. Then, the frequencies that are out of band of the frequency of interest need to be eliminated. For

example, to identify the meditation state, all the frequencies in the signal that are not corresponding to alpha waves are filtered. Finally, the magnitude of either alpha waves while in a resting/meditative state or beta waves in an attentive/focused state are differentiated from a neutral state of the brain. To analyse a state, a band-pass filter is used to isolate the frequency range appropriate for either alpha waves or beta waves. We used sixth-order Butterworth filters, corresponding to

$$\omega = [A \ B], \quad (1)$$

where ω contains the cut-off frequencies of the filter, A and B are the individual cut-off frequencies, normalised to the Nyquist frequency ($f_N = 256$ Hz). Hence, the normalised lower cut-off frequency for the filter can be obtained by f_L/f_N , where f_L is the lower cut-off frequency. Similarly, the normalised higher cut-off frequency can be obtained by f_H/f_N , where f_H is the higher cut-off frequency. This leads to

$$\omega_\alpha = [0.03125 \ 0.05468] \quad (2)$$

$$\omega_\beta = [0.05468 \ 0.078125], \quad (3)$$

Respectively, for the alpha and beta waves. The frequency band using ω_α includes $f_L = 8$ to $f_H = 14$ Hz and the frequency band using ω_β includes $f_L = 14$ Hz to $f_H = 20$ Hz. Since it is the intention to use this for biometric security, users switch between these states in a distinct pattern. The transitions between them are included in the measurements. In a meditative state, eyes are closed, breathing is slowed down, and a single thought is sustained. During the attentive state, some new information is read or some mathematical problems are solved. The neutral state consists of opened eyes but otherwise no exertion.

In Fig. 3, the difference in alpha activity between the meditative state and the neutral state is shown. This plot results from a continuous measurement of 40 s which includes the transition between the states halfway through. We observe in the figure that the amplitude of the brain signal in meditative state is high when compared with that in neutral state. Similarly, beta activity during the transition between the neutral state and the attentive state is shown in Fig. 4. The output signal from the EEG sensor has been smoothed-out using a moving average filter with a span of 100 samples. Given these outputs, the state can be identified, using the history of the time-domain signal. After filtering and transformation into the frequency power spectrum, the states are identified by magnitude within the two ranges.

For an individual, the magnitude of alpha and brain waves in the neutral state has almost the same magnitude over time compared to meditative or attentive states, respectively. In both Figs. 3 and 4, the magnitude of alpha and beta waves are almost equal to 500 over the time period. This corresponds to the neutral state. The magnitude of alpha wave in the meditative state has a peak reaching up to 2000 and beta wave up to 800 during attention. This magnitude holds true only for a particular individual where NeuroSky electrode is placed in the Fp1 location of his/her head. This threshold may vary for different users with an electrode placed in the same location or for the same user with an electrode at different locations on the forehead. Considering the neutral condition (where the individual is in relaxed state, not doing any work) as a reference, the magnitude of alpha and beta waves during meditative and attentive states are identified to differentiate between these two mental states. A combination of alpha and beta waves recorded over specific time can be used to generate a biometric password. Several subwindows are considered, wherein each window, the user has to perform a specific task to induce alpha or beta waves at high concentration. Fig. 5 shows a sample pattern with a total time of 23 s which includes four subwindows with 5, 5, 8, and 10 s in series, respectively. For the first 5 s, alpha waves in high concentration are induced by meditation. For the next 5 s, the user is not doing any task and is being neutral. The last two windows include high-amplitude beta waves and a neutral state, stimulated by being attentive and neutral, respectively. This

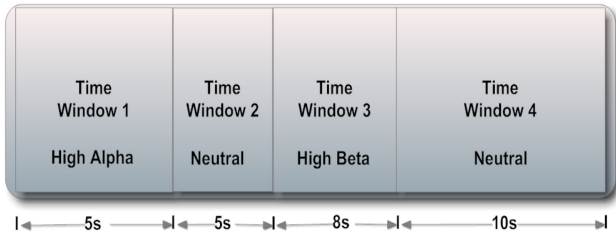

Fig. 5 Subwindow

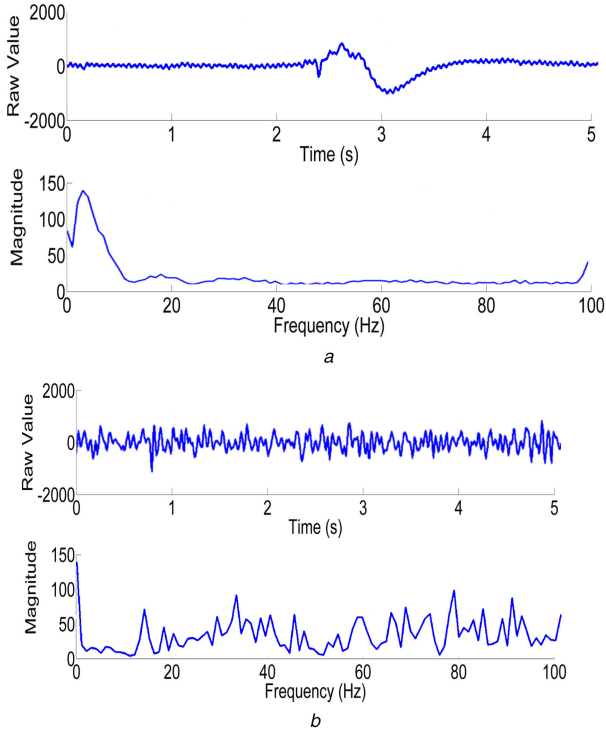

Fig. 6 Signal processing
(a) EEG output with blinking, (b) EEG output with jaw tension

whole pattern recorded for 23 s will form the biometric password that can be used to secure a system. The system can be unlocked only if the same pattern is generated which is only possible by the rightful user who knows the password. This pattern is more difficult to replicate by anyone other than its creator. Though we consider a sample window with a total duration of 23 s, the duration of each subwindow, hence, the total lock/unlocking time can be varied. However, this depends on the capability of the user to switch between different mental tasks in the specific time period. This uniqueness is also an advantage in terms of security as the lock pattern cannot be replicated by another user easily.

Once the password pattern is generated for a specific duration, it is stored in the Android device securely along with the length of each subwindows. On the fly when a user wants to lock/unlock the system, the EEG signal from the sensor is acquired. As soon as the acquisition time matches with the first window of the password, the mental state in the acquired subwindow is identified comparing it with the neutral state which is considered as a reference. If a match is found, then the same process is repeated for subsequent subwindows until all the subwindows provide matching between the password pattern and acquired signal. The magnitude of samples in each subwindow can be found as below

$$S_t = \sum_{i=1}^n f_t[i], \quad (4)$$

where S_t is the sum of the magnitude of samples in the window t and n the number of samples in the fast Fourier transform (FFT) of acquired signal, $f_t[i]$, in the subwindow t .

If T_s is the threshold for state s (attention or meditation) calculated with reference to neutral state for the user, if $S_t \geq T_s$, then the mental task performed in subwindow t is s . In this way, every task in each subwindow of the password has to be compared with that of acquired signal to get a match. On the perfect match, the system is unlocked.

In this experiment, we considered only alpha waves and beta waves as they can be measured in the frontal lobe efficiently during meditation and attention. Moreover, single electrode sensor limits the potential to measure other neural oscillations. When a greater number of electrodes and more types of brain waves are considered, multiple secured passwords with different combinations of varying subwindows could be generated in a shorter period.

4.2 EMG pattern recognition

As an alternative to attempting to read the EEG signals, the electrical potentials associated with EMG, or the activity of muscles, can be analysed with the same sensor. In our experiments, two scenarios exploiting the disruptive signal provided by muscle movements in the head are used control signals.

In the EMG measurements from the MindWave Mobile headset, blinking of the eyes causes a waveform of a single period with significant amplitude which can be seen in Fig. 6a. Whereas blinking gives this single, instantaneous event, a continuous signal can be achieved by tensing of muscles. A strong example of this follows from clenching the jaw, as can be seen in Fig. 6b. The muscle tension causes a continuous signal composed of a broad range of frequencies that are different from the blinking.

4.2.1 Blink detection: The EEG signal pattern generated while blinking is different for different people. Even though a single pulse is generated for every blink, the amplitude, frequency, and phase of the pulse can vary for different persons. Hence, it is not efficient to assign a common threshold to these signal parameters to detect blinking. Owing to the distinct shape of the influence of blinking on the EEG, a correlation function is used to identify blinking. A stored pattern of blinking for a particular user, 250 samples in length, is constantly compared with the filtered previous 250 samples received from the headset. This is done according to

$$C = \sum_{i=1}^{250} P[i]D[i], \quad (5)$$

where C is the current measure of correlation, P a vector containing the stored pattern of blinking, and D a vector consisting of filtered last 250 received samples of data. Specifically, we use filter

$$D[n] = c_1S + c_2D[n-1], \quad (6)$$

where again D is a vector containing the stored data, S is the newly received sample, and c_1 and c_2 are constants determining the weight of new samples. Values of $c_1 = 0.1$ and $c_2 = 0.9$ were found empirically to get the desired low-pass behaviour. To illustrate this, Fig. 7 shows the filtering applied to the raw signal. The stored blinking pattern used in the correlation function and the measure of correlation between the stored pattern and the filtered data while blinking is shown in Fig. 8.

Hysteresis thresholds within the correlation result in (5) then determine when a blink has occurred. To further modulate information with blinking, consecutive blinks within 1 s of each other are counted. This causes a delay in the output of the signal equal to the allowed time between blinks in exchange for the ability to differentiate between different blinking patterns.

4.2.2 Jaw tension detection: The influence of muscle tension in the jaw is most distinctly characterised by the broad range of frequencies which begin to occur. If the average of frequencies in this range within the frequency domain is taken, however, interference such as blinking can still result in a higher magnitude

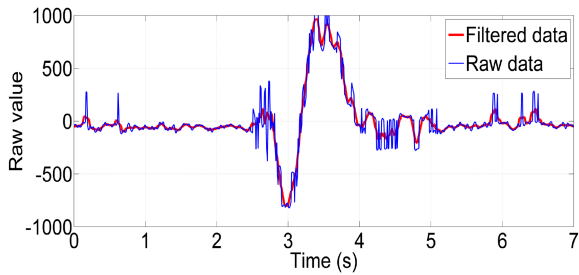

Fig. 7 Raw and filtered data through blinking

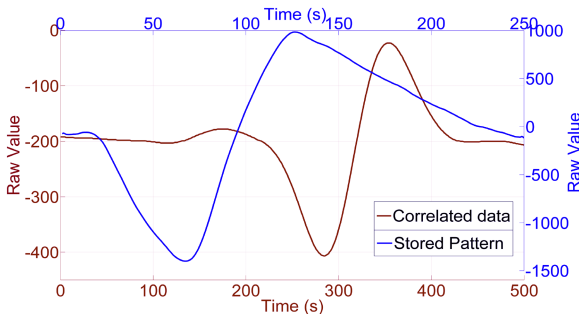

Fig. 8 Stored pattern and correlation function through blinking

```

1: procedure DETECTJAW(last second of raw data, minimum frequency, maximum frequency, number of regions, inner threshold, outer threshold, hysteresis margin)
2:   transformed data  $\leftarrow$  power spectrum(FFT(last second of raw data));
3:   active regions  $\leftarrow$  0;
4:   for each regions do
5:     signal  $\leftarrow$  0;
6:     for each sample within region do
7:       if transformed data sample > inner threshold then
8:         signal  $\leftarrow$  signal + transformed data sample - inner threshold;
9:       if signal > outer threshold then
10:        active regions  $\leftarrow$  active regions + 1;
11:      if active regions = number of regions then
12:        jaw tension  $\leftarrow$  true;
13:      else
14:        if active regions < number of regions - hysteresis margin then
15:          jaw tension  $\leftarrow$  false;

```

Fig. 9 Algorithm 1: Jaw tension detection

than tensing the jaw. Moreover, as can be seen in Fig. 6b, the magnitude is discontinuous over this range of frequencies.

To identify jaw tension, an algorithm is devised which differentiates solely based on the range of frequencies, within a margin of many discontinuities in magnitude over that range. The corresponding pseudocode is shown in Algorithm 1 (see Fig. 9). In the frequency domain, power spectrum of ten evenly spaced regions are defined. This width must be enough to overcome the discontinuity of the spectrum. Within each region, a threshold of magnitude is checked. Then, by the number of regions exhibiting a signal, jaw tension is detected. In the given algorithm, a frequency range of 20–90 Hz, a choice of ten regions, an inner threshold of 15, an outer threshold of 0, and a hysteresis margin of 4 result in a sufficiently robust detection scheme.

5 Implementation

In this section, we explain our experimental set-up and different modules involved in the set-up.

5.1 Experimental set-up

To analyse the EEG signals, the raw data obtained from the electrode is sampled at 512 Hz and sent over a Bluetooth

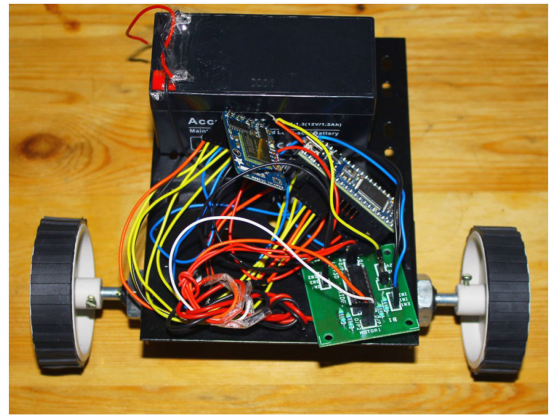

Fig. 10 Prototype of the wheel chair

connection to a mobile device, which a patient could easily carry around while operating the wheelchair. Here, the Android operating system is used to process the raw data. An application is developed to process the signal and output commands to the wheelchair to control its movement. This last step of communication is through Wi-Fi. The wheelchair is represented by a small robot vehicle. It includes a Wi-Fi chip to interpret commands and has two motorised wheels, just as a wheelchair would have. This experimental set-up is used to analyse the different brain waves and its properties so that a prototype can be built.

We built a prototype consisting of a robotic vehicle to imitate a wheelchair and a biometric security system to demonstrate how BCI can be used in security applications. With this prototype, we demonstrate:

- moving a wheelchair in all directions using EMG signals (blink detection and jaw tension detection),
- a biometric security system to lock and unlock the wheelchair using EEG signals (alpha and beta waves) so that the movement can be controlled later.

We provide implementation and details of testing the proposed idea with a prototype as follows:

- Wheel chair movement:* The prototype consists of a server program running on a PC to which an Android mobile and the wheelchair are connected. We use a two-wheeled robotic vehicle that acts as a wheelchair as shown in Fig. 10. The NeuroSky MindWave Mobile is connected to the mobile via Bluetooth as the signal processing takes place on the mobile device for controlling the movement of the wheelchair. The raw EEG data received on the Android mobile from the EEG headset is processed for blink and jaw tension detection as described in Section 4.2. Creating tension in jaw corresponds to forward movement of the wheelchair. Two fast eye blinks and three fast blinks correspond to left and right turning of the wheelchair, respectively. A blinking pattern for the backward movement was not created, as this can be achieved with the combination of left/right and forward movement. Relaxing the jaw makes the wheelchair stop moving forward.
- Biometric security:* To lock or unlock the wheelchair using brain waves, the raw data acquired is processed in the Android device to extract the information from alpha and beta waves to identify the task performed by the user as either attention or meditation. The wheelchair is secured with a password. This password is a combination of mental tasks performed by the user, generated using the information obtained from alpha and beta waves, as explained in Section 4.1. The wheelchair is unlocked and allowed to control the movement only if the user is able to generate the pattern by performing mental tasks, which is same as the password pattern.

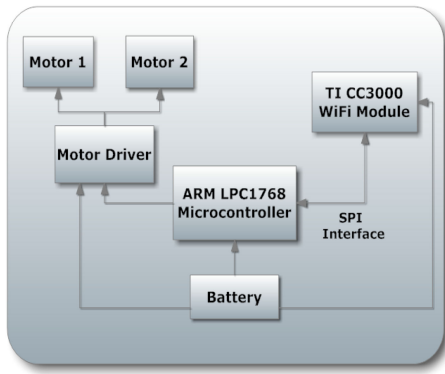

Fig. 11 Modules of the wheel chair

5.2 Components

The components of the set-up are described below.

5.2.1 Server: Although the server is not required in the case of a one-to-one Wi-Fi connection from the Android mobile to the wheelchair directly, a centralised server system running on a PC is developed, which acts as a mediator to establish a connection between the mobile device and the wheelchair. Any number of other devices and applications can be connected to this centralised server to perform specific predefined tasks depending on the mental or muscular effort performed by a user. On startup, the server will be waiting for the devices to connect. There is no predefined order for any of these devices to get connected to the server as the identification of devices takes place internally. Once both the mobile device and wheelchair are connected to the server, the wheelchair movement is controlled by blinking and creating tension in the jaw.

5.2.2 Mobile application: An Android mobile application was developed to which the NeuroSky MindWave headset can be connected via Bluetooth. The complete signal processing algorithm for blink and jaw tension detection is run by this app to control the wheelchair. The existing jTransforms library is used to calculate the FFT of the raw EEG signals on Android mobile. Once the signals are processed, the statuses of blinking and jaw tension events are sent to the server. The server sends corresponding commands to the wheelchair as the front, left, right, and stop for the tasks jaw tension, two blinks, three blinks, and jaw relaxation, respectively.

5.2.3 Wheelchair: The wheelchair is represented by a two-wheeled robotic vehicle that was assembled from scratch. It consists of two motors fitted to the wheels, a motor driving circuit to drive the motors in forward and reverse directions, an ARM Cortex M3 microcontroller (LPC1768) whose purpose is to communicate to the server via TI's CC3000 Wi-Fi module and to send commands to the motor driver. Fig. 11 shows the different modules present in the wheelchair.

The screenshot of log messages displayed by the server application and the Android mobile application is shown in Fig. 12.

6 Results and evaluation

Using the prototype, the EMG and EEG pattern detection schemes were tested. Based on these results, the proposed approach is evaluated.

6.1 EMG detection analysis

The movements of the wheelchair for EMG detection are tested for accuracy with multiple users. Randomly, ten people were asked to wear the NeuroSky MindWave headset and control the movement of a wheelchair in all directions. Before starting the test, each person's blink pattern was recorded using the headset and stored on the Android mobile. This pattern could then be used by the

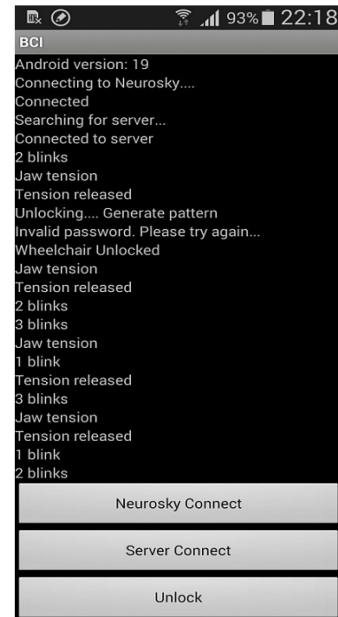
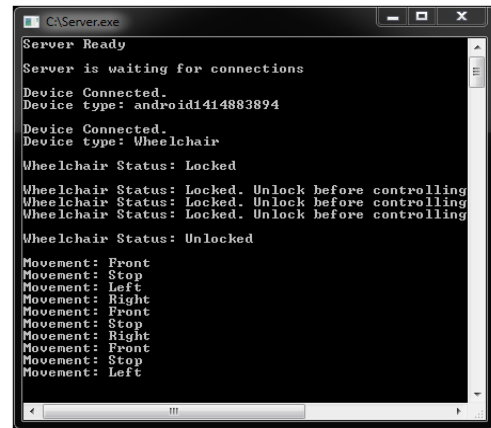

Fig. 12 Log messages displayed on server and Android application

application to correlate with the raw EEG signals during online eye blink detection. It was observed that the amplitude threshold set for jaw tension detection for one user did not provide accurate results for the next user. Hence, for each person, different thresholds were set in the code for jaw tension detection. During testing, the actual action performed by every user and the resulting movement of the wheelchair is noted in each trial. The matching between blink and jaw tension patterns and the actual movement is done as follows:

- Front movement: Creating tension in the jaw.
- Stop moving: Releasing the tension on the jaw.
- Left turn: Blinking both the eyes twice, with no more than 1 s between blinks.
- Right turn: Blinking both the eyes thrice, with no more than 1 s between blinks.

Table 1 shows the confusion matrix obtained for an intended action performed and the observed wheelchair movement. This matrix was generated by considering the average of all the movements commanded by all ten persons. Totally, there were 110 movements commanded by 10 people. The movement along the rows specifies the action performed by the user and column indicates the movement of the wheelchair. From the table, it is evident that the accuracy is >86% since the non-principal diagonal elements are >0.86. The most accurate command was 'Stop' as this could happen only when there is a transition from tensed to released state of the jaw. The forward movement of the wheelchair is 96% accurate where 2% is lost to the action 'Left' and rest 2% for 'No task'. This is because, for jaw tension created by some of the users, the transition triggered one blink and two blinks which

Table 1 Confusion matrix obtained via blinking and jaw tension

	Front	Left	Right	Stop	No task
front	0.96	0.02	0	0	0.02
left	0	0.88	0.02	0	0.1
right	0	0.11	0.86	0	0.03
stop	0	0	0	0.98	0.02
no task	0	0.06	0	0	0.94

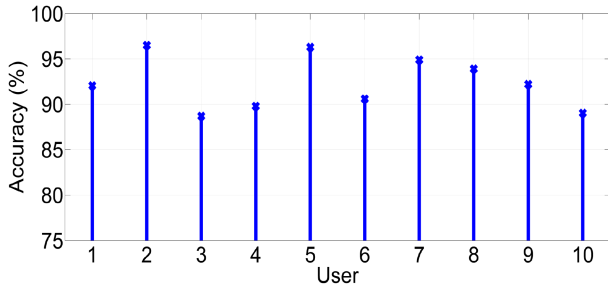
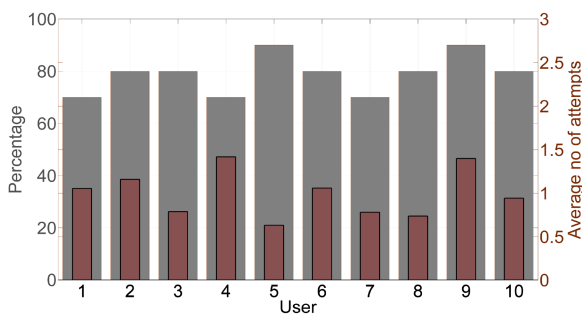
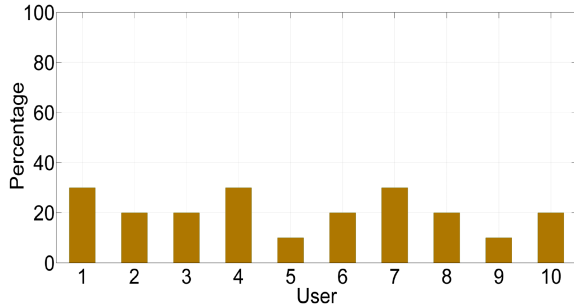
**Fig. 13** Accuracy of blink and jaw tension detection from each user**Fig. 14** Success rate**Fig. 15** False unlocking rate

corresponded to ‘No action’ and ‘Left’, respectively. The Left movement is 88% accurate. Higher percentage for ‘Left’ is lost to ‘No task’ as out of two blinks performed to command ‘Left’, only one blink was detected sometimes which matched ‘No task’. Similarly, the three blinks were detected as two blinks by the Android application sometimes for ‘Right’ movement which resulted in 86% accuracy.

The accuracy of pattern recognition by the application including both blink and jaw tension for tasks performed by each user is represented in a bar chart as shown in Fig. 13. The accuracy for each user is calculated as, the number of trials for which correct movement observed for corresponding user action over total number of trials. The maximum accuracy achieved is 96.3%.

6.2 EEG detection analysis

The EEG pattern recognition approach was tested using the same wheelchair where users were asked to lock/unlock it. The prototype was evaluated with the help of ten people. Each person was asked to create a password to secure the wheelchair, by performing mental tasks: meditation, attention, and a neutral state randomly for a specific amount of time. The combination of these states was left

to the user. The raw EEG signals from each user were stored on a PC when these actions were performed. The individuals were also asked to set the duration of each subwindow >5 s. For instance, a random task set containing four subwindows can be: meditating for 5 s, being neutral for 5 s, meditating for 8 s, and finally being attentive for 10 s. This forms the password: meditate–neutral–meditate–attention. The number of subwindows and subwindow durations had to be memorised by the user so that he/she can generate the same pattern (password) again. Though the way of performing different tasks such as attention and meditation can be chosen by the user, for experimental purposes, they were provided with some specific tasks. Each user meditated in his/her own way by closing their eyes to induce more alpha waves. To stimulate high concentration of beta waves, they were given with mathematical equation to solve (attention), asked them to read some texts or to solve some puzzles. The password thus stored for all ten users formed training data and the wheelchair was locked using the respective password for the corresponding user, during the test.

While testing, the individuals were asked to induce the same EEG pattern again to unlock the wheelchair with their unique password. Each user was asked to unlock the wheelchair ten times. Since it was difficult to generate EEG pattern all the times in a single trial, they were provided with five trials to unlock the file. If the wheelchair was unlocked within these five trials, then it was considered a success; else it was considered a failure. Hence, every person had to unlock the wheelchair ten times with five trials provided for each unlocking session. The success rate (SR) and false unlocking rate (FUR) for each unlocking trial can be described as follows:

$$SR = \frac{\text{Number of times the wheelchair was unlocked}}{\text{Total number of unlocking sessions}} \quad (7)$$

$$FUR = \frac{\text{Number of times a user was not able to unlock}}{\text{Total number of unlocking sessions}} \quad (8)$$

The SR and FUR obtained with ten users are shown in Figs. 14 and 15, respectively. When few users were asked to perform specific mental tasks for different time intervals (subwindow), they had to count the time so that the mental state can be changed then. Since all tasks such as meditation, attention, including counting the time were controlled by the brain, the meditation and attention tasks were affected by time counting. This resulted in almost equal amplitude levels by both alpha and beta frequencies as there was mix up of tasks in the brain, generating irregular patterns, both for password and during testing. In order to eliminate the problem with time counting, multiple alarm were set on the Android mobile to beep at specific intervals of user's choice to indicate the user to change his/her task.

On observing the obtained SR and FUR, we see that the maximum SR achieved was 90% and the least FUR was 10%. From these results, it can be concluded that when a person can perform single task like meditation or attention without any disturbance, higher SR can be achieved even when single BCI electrode is used.

Fig. 16 shows the CDF plot of the number of trials each user has taken to unlock the wheelchair successfully. It is evident from the plot that all users were able to unlock the wheelchair within provided five trials. The histogram of a number of trials is shown in Fig. 17 which reveals that out of total 100 trials, the system was unlocked 35 times in 1 trial, 37 times in 2 trials, and 19 times in 3 trials.

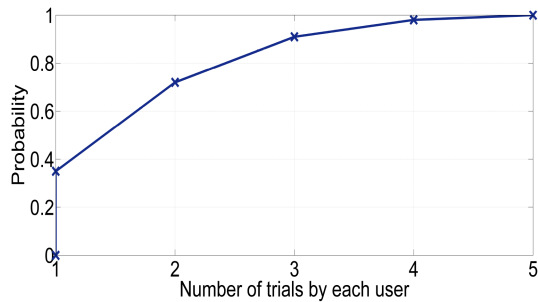

Fig. 16 CDF plot of number of trials

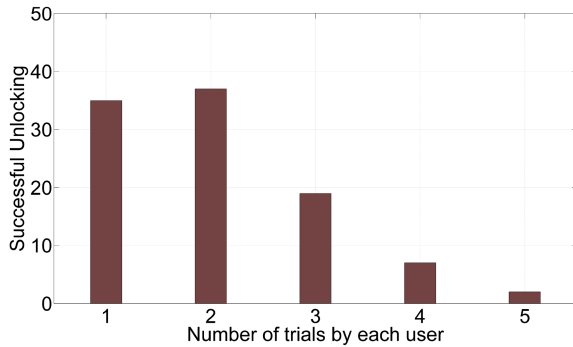

Fig. 17 Histogram of number of trials

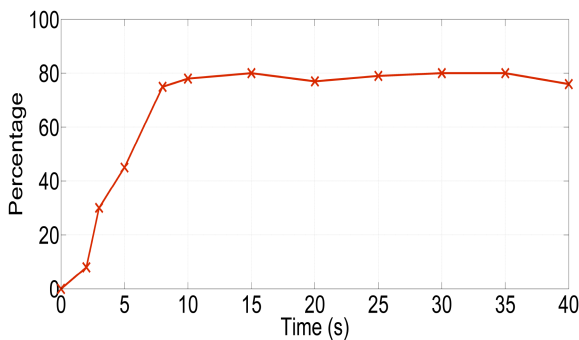

Fig. 18 Success rate with different subwindows

In this experiment, NeuroSky Mindwave headset having single electrode was used to capture brain waves from the frontal lobe. After analysing the stored EEG patterns of all ten users, it was observed that the number of subwindows, duration of each subwindow, and the total length of password were different, hence providing a secured password. This helped a lot in achieving low FUR. Since the system is applicable in the field of security, the FUR should be as low as possible, ideally equal to zero. The FUR can be decreased and best security can be provided in several ways:

- i. Multiple tasks (brain waves): Along with the tasks that induce alpha and beta waves, if other tasks which stimulate theta, delta, and gamma waves are considered in the proposed approach, then the password will be stronger, decreasing the FUR almost to zero. To achieve this, different sensors have to be placed in multiple locations on the head as per 10–20 system.
- ii. Multiple electrodes: The concentration of a specific brain wave is higher in particular brain lobe when a certain task is performed. For instance, the alpha waves have a higher magnitude in the parietal lobe when the user is visually attentive. The alpha waves can be detected in the occipital lobe for the same task but will be with less magnitude. Hence for a specific mental task, multiple electrodes have to be placed in different parts of the brain to identify the presence of particular brain wave accurately. Therefore, the SR can be increased and the FUR can be decreased if multiple electrodes are used to measure the brain waves from different parts of the brain.

Considering the combination of different subwindows, multiple mental tasks (brain waves), and multiple electrodes, it is possible to obtain a stronger secured password which is almost impossible to break using brute force.

Fig. 18 shows the average SR from ten users at different subwindows until 40 s. From the graph, we observe that the SR is less for shorter subwindows such as 5 s. The reason for this is that a person cannot easily switch between tasks like meditation and attention in a short time. The value starts stabilising at around 10 s after which the SR stays high. This 10 s is sufficient enough to transit from neutral to meditative or attentive states and vice versa. The subwindow duration depends on the type of task that a person is performing and also his capability to switch to another task in less time. Further, it should be considered that with longer subwindows, there is a possibility that the SR might decrease as the individual may not be able to stick to the particular task that he is performing, for a longer duration.

For some of the users, the alpha waves (meditation) were clearly distinguishable from being neutral. For the rest of the users, the beta waves were dominant. Hence, the SR and the detection possibility completely depend on the discipline of the individual.

7 Conclusion

In the context of IoT, this work presented several novel interconnections between humans and the IoT systems. EMG data was measured with the NeuroSky WindWave Mobile headset and interpreted on an Android device. The derived signals were published over Wi-Fi to a server. This server, in turn, was made capable of interpreting EEG data for the purposes of biometric security. The server connected to a robot representing the wheelchair. Commands forwarded to this robot were executed, making it possible to control it with eye blinks and creating tension on the jaw.

The algorithm currently implemented on the Android device for the identification of a user based on EEG patterns can further be converted to C code. This way, it can be executed on a microcontroller instead, increasing the applicability of the security implementation. In the present implementation, the blink pattern for every user has to be stored beforehand so that it can be used for correlation later. Moreover, the amplitude threshold set for jaw tension detection varies for different individuals. We want to eliminate this and make the system user-independent. A higher success rate with smaller subwindows in the biometric security system is desired. The usage of multiple electrodes is one avenue for further work to achieve this. This would also give a higher overall security and accuracy.

A video, demonstrating the prototype, can be found at <https://www.dropbox.com/s/s0u88fwosa4qxse/Video.mp4?dl=0>.

8 References

- [1] Gurkok, H., Nijholt, A.: 'Affective brain-computer interfaces for arts'. Proc. Humaine Association Conf. on Affective Computing and Intelligent Interaction, Geneva, 2013
- [2] Erp, J.B.F., Brouwer, A.: 'Touch-based brain computer interfaces: state of the art'. Proc. IEEE Haptics Symp., Houston, TX, 2014
- [3] Marshall, D., Coyle, D., Wilson, S., *et al.*: 'Games, gameplay, and BCI: the state of the art', *Proc. IEEE Trans. Comput. Intell. AI Games*, 2013, **5**, (2), pp. 82–99
- [4] Vourvopoulos, A., Liarokapis, F.: 'Robot navigation using brain-computer interfaces'. Proc. IEEE 11th Int. Conf. on Trust, Security and Privacy in Computing and Communications, Liverpool, 2012
- [5] Leeb, R., Tonin, L., Rohm, M., *et al.*: 'Towards independence: a BCI telepresence robot for people with severe motor disabilities', *Proc. IEEE*, 2015, **103**, (6), pp. 969–982
- [6] Lee, P.J., Chin, S.W.: 'Early childhood educator assistant with brain computer interface'. Proc. Int. Conf. on Software Intelligence Technologies and Applications & Int. Conf. on Frontiers of Internet of Things 2014, Hsinchu, 2014
- [7] Tan, H.H., Chin, S.W.: 'Personal career planner via brain-computer interface'. Proc. Int. Conf. on Software Intelligence Technologies and Applications & Int. Conf. on Frontiers of Internet of Things 2014, Hsinchu, Taiwan, 2014
- [8] Rihana, S., Damien, P., Moujaess, T.: 'EEG-eye blink detection system for brain computer interface'. Proc. Converging Clinical & Engineering. Research on NR, BIOSYSROB, Springer, Berlin, Heidelberg, 2013
- [9] NeuroSky: 'MindWave datasheet EN'. NeuroSky Inc., Head Set Features + Technical Specifications, 2011

- [10] Hortal, E., Ubeda, A., Ianez, E., *et al.*: 'Online classification of two mental tasks using a SVM-based BCI system'. Proc. 6th Annual Int. IEEE EMBS Conf. on Neural Engineering, San Diego, California, 6–8 November 2013
- [11] Hal, B.V., Rhodes, S., Dunne, B., *et al.*: 'Low-cost EEG-based sleep detection'. 36th Annual Int. Conf. of the IEEE Proc. Engineering in Medicine and Biology Society (EMBC), Chicago, IL, 2014
- [12] Campisi, P., Rocca, D.L.: 'Brain waves for automatic biometric-based user recognition', *Proc. IEEE Trans. Inf. Forensics Sec.*, 2014, **9**, (5), pp. 782–800
- [13] Huang, T.W., Tai, Y.H., Tian, Y.J., *et al.*: 'The fastest BCI for writing Chinese characters using brain waves'. Proc. Fourth Global Congress on Intelligent Systems, Hong Kong, 2013
- [14] Sarmiento, L.C., Cortes, C.J., Bacca, J.A., *et al.*: 'Brain computer interface (BCI) with EEG signals for automatic vowel recognition based on articulation mode'. Biosignals and Biorobotics Conf. Proc. Biosignals and Robotics for Better and Safer Living (BRC), Salvador, 2014
- [15] Chai, R., Ling, S.H., Hunter, G.P., *et al.*: 'Brain computer interface classifier for wheelchair commands using neural network with fuzzy particle swarm optimization', *Proc. IEEE J. Biomed. Health Inf.*, 2014, **18**, (5), pp. 1614–1624
- [16] Reshmi, G., Amal, A.: 'Design of a BCI system for piloting a wheelchair using five class MI based EEG'. Proc. Third Int. Conf. on Advances in Computing and Communications, Cochin, 2013
- [17] Eid, M., Fernandes, A.: 'Readgogo!: towards real-time notification on readers' state of attention'. Proc. XXIV Int. Conf. on Information, Communication and Automation Technologies (ICAT), Sarajevo, 2013
- [18] Zhuang, T., Zhao, H., Tang, Z.: 'A study of brainwave entrainment based on EEG brain dynamics', *Proc. Comput. Inf. Sci. J.*, 2009, **2**, (2), pp. 80–86
- [19] <http://www.brainworksneurotherapy.com/what-are-brainwaves>, 1 May 2015