



Delft University of Technology

Volterra equations with periodic nonlinearities

Smirnova, Vera B.; Proskurnikov, Anton V.

DOI

[10.1142/S0218127419500688](https://doi.org/10.1142/S0218127419500688)

Publication date

2019

Document Version

Final published version

Published in

International Journal of Bifurcation and Chaos

Citation (APA)

Smirnova, V. B., & Proskurnikov, A. V. (2019). Volterra equations with periodic nonlinearities. *International Journal of Bifurcation and Chaos*, 29(5), Article 1950068. <https://doi.org/10.1142/S0218127419500688>

Important note

To cite this publication, please use the final published version (if applicable).
Please check the document version above.

Copyright

Other than for strictly personal use, it is not permitted to download, forward or distribute the text or part of it, without the consent of the author(s) and/or copyright holder(s), unless the work is under an open content license such as Creative Commons.

Takedown policy

Please contact us and provide details if you believe this document breaches copyrights.
We will remove access to the work immediately and investigate your claim.

Green Open Access added to TU Delft Institutional Repository

'You share, we take care!' - Taverne project

<https://www.openaccess.nl/en/you-share-we-take-care>

Otherwise as indicated in the copyright section: the publisher is the copyright holder of this work and the author uses the Dutch legislation to make this work public.



Volterra Equations with Periodic Nonlinearities: Multistability, Oscillations and Cycle Slipping

Vera B. Smirnova

Department of Mathematics,

*St. Petersburg State University of Architecture and Civil Engineering,
2-nd Krasnoarmeiskaya St. 4, St. Petersburg 190005, Russia*

*Faculty of Mathematics and Mechanics, St. Petersburg State University,
Universitetsky Pr. 28, Peterhof, St. Petersburg 198504, Russia
root@al2189.spb.edu*

Anton V. Proskurnikov

*Delft Center for Systems and Control at Delft University of Technology,
Mekelweg 2, Delft, 2628 CD, The Netherlands*

*Institute for Problems of Mechanical Engineering
of the Russian Academy of Sciences (IPME RAS),
V.O., Bolshoj Pr., 61, St. Petersburg 199178, Russia
anton.p.1982@ieee.org*

Received August 27, 2018

In this paper, systems of nonlinear integro-differential Volterra equations are examined that can be represented as feedback interconnections of linear time-invariant block and periodic nonlinearities. The interest in such systems is motivated by their numerous applications in mechanical, electrical and communication engineering; examples include, but are not limited to, models of phase-locked loops, pendulum-like mechanical systems, coupled vibrational units and electric machines. Systems with periodic nonlinearities are usually featured by multistability and have infinite sequences of (locally) stable and unstable equilibria; their trajectories may exhibit nontrivial (e.g. chaotic) behavior. We offer frequency-domain criteria, ensuring convergence of any solution to one of the equilibria points, and this property is referred to as the *gradient-like* behavior and corresponds to phase locking in synchronization systems. Although it is hard to find explicitly the equilibrium, attracting a given trajectory, we give a constructive estimate for the distance between this limit equilibrium and the initial condition. The relevant estimates are closely related to the analysis of *cycle slipping* in synchronization systems. In the case where the criterion of gradient-type behavior fails, a natural question arises — which nonconverging solutions may exist in the system and, in particular, how many periodic solutions it has. We show that a relaxation of the frequency-domain convergence criterion ensures the absence of high-frequency periodic orbits. The results obtained in the paper are based on the method of integral quadratic constraints that has arisen in absolute stability theory and stems from Popov's techniques of "a priori integral indices". We illustrate the analytic results by numerical simulations.

Keywords: Integral equations; nonlinear system; multistability; oscillations.

1. Introduction

The idealistic model of a mathematical pendulum, that is, a point mass swinging on an weightless and inextensible cord, is a textbook example of a planar nonlinear system with a periodic nonlinearity. In spite of their simplicity, pendulum-like models describe a broad class of natural and engineered systems, from vibration units and electric machines to quantum oscillators and Josephson junction arrays [Baker & Blackburn, 2005; Stoker, 1950; Leonov *et al.*, 1996b; Blekhnman, 2000; Czolczynski *et al.*, 2012; Fradkov, 2017]. More general equations with scalar or vector periodic nonlinearities naturally describe phase-locked loops (PLL) and other synchronization systems [Lindsey, 1972; Leonov, 2006], broadly used in communication and electronic engineering for carrier recovery in demodulator circuits, time synchronization, frequency synthesis, clock and data recovery in communication networks [Gardner, 1966; Lindsey, 1972; Margaritis, 2004; Best, 2003; Razavi, 2003]. Periodic nonlinearities in the corresponding mathematical models naturally represent nonlinear characteristics of *phase detectors* (comparators). This paper deals with a general class of infinite-dimensional systems with periodic nonlinearities and establishes a number of analytic criteria, ensuring their convergence and nonoscillatory properties.

1.1. Literature survey

Systems with periodic nonlinearities can often be transformed into dynamical systems on toric or cylindrical manifolds [Kudrewicz & Wasowicz, 2007; Leonov *et al.*, 1996a]. Considered in the Euclidean space, such systems are *multistable* and have infinite sequences of equilibria. Many effects, observed in multistable systems, e.g. hidden oscillations and attractors [Leonov & Kuznetsov, 2013; Dudkowski *et al.*, 2016] or cycle slipping [Ascheid & Meyr, 1982], cannot be examined via linearizations at equilibria and require special “nonlocal” techniques. Even simple models of PLLs had not been rigorously investigated until recently [Chicone & Heitzman, 2013; Leonov & Kuznetsov, 2014; Leonov *et al.*, 2015a, 2015b; Best *et al.*, 2016]. Even more complicated is the theory of *networks* with periodic couplings, referred to as the Kuramoto’s [Strogatz, 2000; Dörfler & Bullo, 2014] or “phase-locked” networks [Monteiro *et al.*, 2003]. Many important effects in such networks are still waiting for

mathematically rigorous analysis. Such networks naturally arise as approximations of pulse-coupled oscillator ensembles and have found many applications in neuroscience [Izhikevich, 1999; Hoppensteadt & Izhikevich, 2000; Proskurnikov & Cao, 2017].

Most of the aforementioned works are confined to the case of ordinary differential equations, whereas many practically important systems with periodic nonlinearities are essentially *infinite-dimensional*; the ODE models can be considered only as their approximations. One standard “culprit” of infinite-dimensional dynamics is *communication delay*. Delays are inevitable in many synchronization circuits and may substantially deteriorate the synchronization system’s behavior up to inducing instability [Wischert *et al.*, 1992; Bergmans, 1995; Buckwalter & York, 2002]. Distributed parameter models also naturally represent synchronization systems, whose *loop filters* [Best, 2003; Margaritis, 2004] have nonrational transfer functions; this holds e.g. for *fractional-order* filters that have much better attenuation of high frequencies [Hélie, 2014] than integer-order filters. As reported in [Tripathy *et al.*, 2015], a PLL with a fractional-order filter “can provide faster response and lower phase error at the time of switching compared to its integer-order counterpart”. In some models of PLLs, both infinite-dimensional filters and delays are present [Yu & Wang, 2013]. Even being a finite-dimensional system itself, a synchronization circuit may be incorporated into some infinite-dimensional control system. For instance, some approaches to active vibration control for flexible beams [Balas, 1978; Niezrecki & Cudney, 1997] employ PLLs as “residual mode” filters [Lin, 1993] to suppress unmodeled high-frequency oscillations. Although a straightforward engineering approach to the analysis of such a system is to replace the distributed-parameter system by its finite-dimensional approximation (assuming that the infinite-dimensional “residual dynamics” is attenuated), its complete model leads to a system of PDE with a periodic nonlinearity (the characteristics of the PLL’s phase detector).

The mathematical results, regarding the dynamics of infinite-dimensional systems with periodic nonlinearities, are very limited. Some infinite-dimensional PLL circuits have been studied in [Hoppensteadt, 1983; Skorokhod *et al.*, 2000; Hoppensteadt, 2003], focusing on random and singular

perturbations effects. In this paper, we study the dynamics of a general Lur'e-type system, representable as a feedback interconnection of infinite-dimensional linear part and a finite-dimensional periodic nonlinearity. The linear part is described by the integro-differential Volterra equation, and the nonlinearity can be partially uncertain, satisfying some slope restrictions. Systems of this type describe, in particular, a broad class of PLLs that may have infinite-dimensional loop filters and communication delays. Extending and refining results from the monographs [Leonov *et al.*, 1992; Leonov *et al.*, 1996b] and more recent papers [Perkin *et al.*, 2012; Perkin *et al.*, 2013; Perkin *et al.*, 2014; Smirnova *et al.*, 2015; Perkin *et al.*, 2015; Smirnova & Proskurnikov, 2016], we address the following three problems: the solutions' *convergence* to the set of equilibria, deterministic *cycle-slipping* effects and the *nonexistence of high-frequency oscillations*. The approach is based on the method of integral quadratic constraints (IQC), which originates from Popov's idea of "a priori integral indices" [Rasvan, 2006] and has been developed in the framework of absolute stability theory, see [Megretski & Rantzer, 1997; Yakubovich, 2000, 2002] and references therein. The criteria offered in this paper employ a "frequency-algebraic" condition, consisting of a frequency-domain restriction on the linear part's transfer function and nonlinear algebraic constraints.

1.2. Problems in question and the paper's organization

The paper is organized as follows. Section 2 introduces the class of systems to be considered, key assumptions and relevant notation. Applications are also discussed that lead to the model in question.

Section 3 addresses the first of the aforementioned problems: *to disclose conditions, ensuring convergence of any solution of the system to one of the equilibria points*. In synchronization systems, such a convergence is often referred to as *phase locking*, and the system whose solutions are phase-locked is sometimes called *gradient-like* [Leonov, 2006; Duan *et al.*, 2007]. In this paper, we give novel frequency-domain criteria for gradient-like behavior of synchronization systems, extending the relevant criteria from [Leonov *et al.*, 1992; Leonov *et al.*, 1996b] in the case, where the periodic nonlinearity is slope-restricted. Note that the methods from the works [Leonov *et al.*, 1996a; Gelig *et al.*, 2004;

Leonov, 2006; Duan *et al.*, 2007], addressing the stability problems for systems with periodic nonlinearities, are based on the Kalman–Yakubovich–Popov (KYP) lemma and cannot be employed in the analysis of integro-differential equations.

Section 4 is concerned with the second of the aforementioned problems: *to estimate the equilibrium to which a given solution converges*. A typical question is whether the phase converges to the nearest equilibrium, or leaves its basin of attraction and converges to some distant point. The latter effect is prominently illustrated by a pendulum's rotation around the upper suspension point before calming down at the lower point. In synchronization systems, such a behavior is known as *cycle slipping* [Ascheid & Meyr, 1982], a similar phenomenon is the *step (or pole) skipping* in stepper motors [Stoker, 1950]. In both situations such a behavior is considered as undesirable, leading, respectively, to demodulation errors in communication systems and losing the positioning quality. In the literature on PLLs, stochastic cycle slippings are usually considered that are caused by the presence of random noises and disturbances [Viterbi, 1963; Tausworthe, 1967; Ascheid & Meyr, 1982; Skorokhod *et al.*, 2000]. In this paper, we deal with a deterministic cycle-slipping problem, pioneered in [Ershova & Leonov, 1983]: for a given initial condition, estimate the number of slipped cycles (which, in some sense, may be considered as an estimate for the distance between the initial condition and the solution's limit).

Section 5 is related to the third problem: *in the case where convergence of all solutions cannot be proved by using our criterion, which types of nonconvergent solutions can the system have?* Although this general problem still remains open, one can cope with a simpler problem, addressed in [Shakhgil'dyan & Lyakhovkin, 1972; Yevtyanov & Snedkova, 1968] for PLLs: when does a *periodic* solution of a given period exist? The problem of primary interest is to prove the absence of high-frequency oscillations. Most of the existing works, concerned with the latter problem [Garber, 1967; Leonov & Speranskaya, 1985; Leonov *et al.*, 1996b; Leonov & Fyodorov, 2011; Perkin *et al.*, 2015] exploit the idea of Fourier-series expansion. In Sec. 5, we extend this method to the integral equations and multidimensional nonlinearities.

The concluding Sec. 6 is devoted to discussions, including detailed comparison of our results

with previous works and directions of ongoing research. Some technical proofs are collected in the Appendix.

2. Preliminaries and Notation

Unless otherwise stated, we use lower case letters to denote vectors and *diagonal* matrices; all nondiagonal matrices and sets are denoted by capital letters. As usual, $d = \text{diag}(d_1, \dots, d_n)$ denotes the diagonal $n \times n$ matrix, whose main diagonal is constituted by the scalars d_1, \dots, d_n . A vector $x \in \mathbb{R}^l$ is considered as a column of height l ; $|x| \triangleq \sqrt{x^\top x}$ denotes the Euclidean norm of the vector x . For a matrix A , $|A|$ stands for the induced operator norm, that is, $|Ax| \leq |A||x|$ for any appropriately dimensioned vector x . For a complex-valued matrix H , we use $H^* \triangleq \overline{H}^\top$ to denote its complex-conjugate transpose. If H is a square matrix, let $\text{Re } H \triangleq \frac{1}{2}(H + H^*)$ stand for its symmetrization. A Hermitian matrix $H = H^*$ is positive definite (semidefinite), written $H > 0$ (resp., $H \geq 0$) if $x^* H x > 0$ (resp., $x^* H x \geq 0$) for any vector $x \neq 0$ of the appropriate dimension.

We consider the system of integro-differential Volterra equations

$$\begin{aligned} \dot{\sigma}(t) &= b(t) + R\xi(t-h) - \int_0^t \Gamma(t-\tau)\xi(\tau)d\tau, \\ \xi(t) &= \varphi(\sigma(t)), \quad t \geq 0. \end{aligned} \tag{1}$$

Here $\sigma(t) \in \mathbb{R}^l$ is a vector function; motivated by the applications to synchronization systems, considered below, $\sigma(t)$ is said to be the *phase vector*, and its elements $\sigma_j(t)$, where $j = 1, \dots, l$, are called *phases*. The matrix function $\Gamma(t)$ (the convolutional kernel) and the vector function $b(t) \in \mathbb{R}^l$ are supposed to be known, R is a fixed $l \times l$ matrix and $h \geq 0$ is a constant *delay*.¹ To simplify matters, we consider only smooth solutions $\sigma \in C^1([0, \infty), \mathbb{R}^l)$, such a smoothness is guaranteed by the choice of the initial conditions

$$\begin{aligned} \sigma(\cdot)|_{[-h,0]} &= \sigma^0(\cdot) \in C([-h; 0], \mathbb{R}^l), \\ \sigma(0+) &= \sigma^0(0). \end{aligned} \tag{2}$$

Substituting the second equation in (1) into the first equation, one could get rid of the function $\xi(t)$ and consider (1) as a nonlinear integro-differential

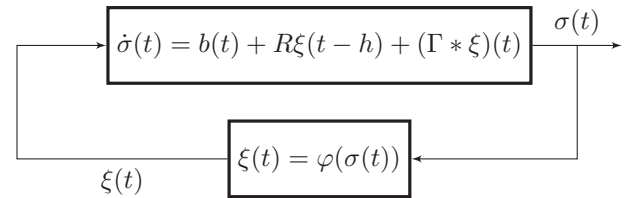

Fig. 1. The system (1) as a feedback interconnection of two subsystems.

delay equation. The representation (1) appears however to be more convenient, decomposing the nonlinear equation into a *feedback interconnection* of two simpler subsystems (Fig. 1). The first of these subsystems is *linear* and described by the convolutional Volterra equation, and the second subsystem is represented by the static nonlinearity $\varphi(\cdot)$. In control theory, such a decomposition is called *Lur'e* form, and the systems representable in this form are referred to as *Lur'e* systems [Lur'e, 1957]. The method used in this paper stems from Popov's method of "a priori integral indices" [Popov, 1973; Yakubovich, 2002; Rasvan, 2006]; along with other methods of "absolute stability" theory [Popov, 1973; Megretski & Rantzer, 1997; Gelig *et al.*, 2004; Yakubovich, 2002], this method deals with Lur'e systems, where the linear part is known, whereas the nonlinear "feedback" can be uncertain.

2.1. Basic assumptions and notation

We start with introducing two basic assumptions, regarding, respectively, the properties of the linear part and the nonlinearity, which are supposed henceforth to hold.

Assumption 1 (Linear Part). The linear part of the system (1) is exponentially stable

$$|b(t)| + |\Gamma(t)| \leq Ce^{-rt}, \tag{3}$$

where $C, r > 0$ are constants. The function $b(t)$ is continuous at any $t \geq 0$.

Assumption 2 (Nonlinearity). The map $\varphi: \mathbb{R}^l \rightarrow \mathbb{R}^l$ is C^1 -smooth and satisfies the following conditions:

- (1) (decoupling) for any $j = 1, \dots, l$, its j th coordinate depends only on σ_j , that is, $\varphi(\sigma) = (\varphi_j(\sigma_j))_{j=1}^l$;

¹For simplicity, we consider only one discrete (lumped) delay, the case of multiple discrete delays h_1, \dots, h_N can be considered without serious changes, replacing $R\xi(t-h)$ by a sum $\sum_{i=1}^s R_i\xi(t-h_i)$.

- (2) (periodicity) each scalar function $\varphi_j(\sigma_j)$ is Δ_j -periodic, that is, $\varphi_j(\zeta + \Delta_j) = \varphi_j(\zeta) \forall \zeta \in \mathbb{R}$ and $\Delta_j > 0$ is the minimum number with such a property;
- (3) (zeros) each function $\varphi_j(\sigma_j)$ has a nonempty zero set, consisting of isolated points;
- (4) (slope restriction) for each $j = 1, \dots, l$ we define

$$\mu_{1j} \triangleq \min_{\zeta \in [0, \Delta_j]} \frac{d\varphi_j(\zeta)}{d\zeta} < 0, \tag{4}$$

$$\mu_{2j} \triangleq \max_{\zeta \in [0, \Delta_j]} \frac{d\varphi_j(\zeta)}{d\zeta} > 0;$$

- (5) (maximal value) for each $j = 1, \dots, l$ we define

$$\hat{\varphi}_j \triangleq \max_{\zeta \in [0, \Delta_j]} |\varphi_j(\zeta)| < \infty. \tag{5}$$

Note that the inequalities $\mu_{1j} < 0 < \mu_{2j}$ in (4) are entailed by conditions (2) and (3): since each of φ_j is nonconstant and periodic, it cannot be monotone, and hence φ'_j changes its sign on $[0, \Delta_j]$.

2.2. Applications

In this subsection, we discuss several applications where the dynamical system (1) naturally arises.

2.2.1. Mathematical pendulum and synchronous motors

A textbook example of a system with periodic nonlinearity is the *pendulum* [Fig. 2(a)], on which a constant rotating torque is applied. Assuming that the cord's mass is negligible compared to the load M ,

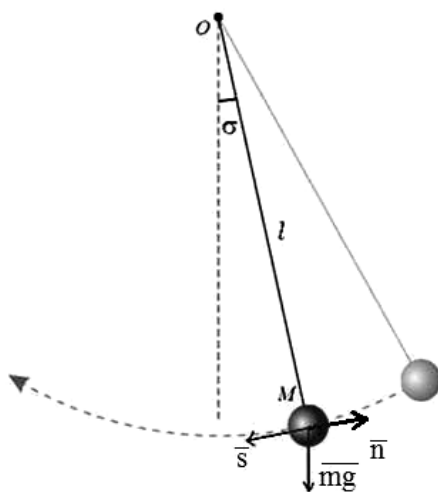

(a)

the cord is inelastic and the damping (viscous friction) force \bar{s} is proportional to the linear velocity of the mass (equivalently, angular velocity $\dot{\sigma}$), the equation of the pendulum is [Stoker, 1950]

$$\ddot{\sigma} + a\dot{\sigma} + b(\sin \sigma - \beta) = 0, \tag{6}$$

where the parameters $a, b > 0$ and $\beta \in \mathbb{R}$ are uniquely determined by the mass of the load (m), the length of the cord (l), the viscous friction coefficient and the rotating torque.

Equation (6) may also serve as a simplistic mathematical model for the synchronous machine, being a reduced form of the well known Park equations [Adkins, 1960; Halanay *et al.*, 1987; Leonov, 2006]. Here $\sigma(t)$ is the angle between the plane of the rotor frame and the plane orthogonal to the magnetic field. The values a, b and β depend on parameters of the rotor and the magnetic field.

Equation (6) is apparently a special case of (1) since

$$\dot{\sigma}(t) = \dot{\sigma}(0)e^{-at} - b \int_0^t (\sin \sigma(\tau) - \beta)e^{-a(t-\tau)} d\tau. \tag{7}$$

2.2.2. Synchronization of vibrational units (“rotors”)

Another example is synchronization of $n \geq 2$ vibroexciters (“rotors”) [Blekhman, 2000], installed on a rigid swinging platform with one degree of freedom and rotated by asynchronous motors [Fig. 2(b)]. The rotors can synchronize without additional mechanical couplings among them [Blekhman, 2000].

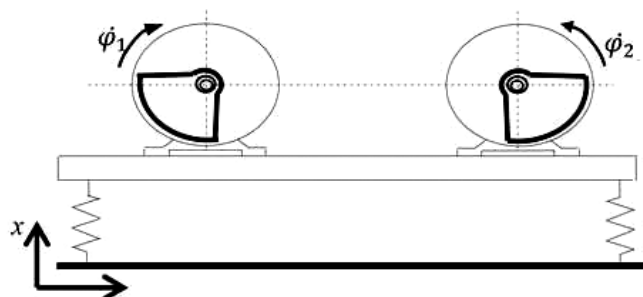

(b)

Fig. 2. Illustrations of Secs. 2.2.1 and 2.2.2: (a) Mathematical pendulum and (b) rotors on a swinging platform.

Consider for simplicity $n = 2$ rotors with angular coordinates φ_i and let x stand for the vertical coordinate of the platform. We assume that rotation torques of the motors are constant, the viscous friction forces are proportional to the respective angular velocities $\dot{\varphi}_i$ and the platform's spring dampers are linear. The equations of the system are as follows [Blekhman, 2000]

$$I_i \ddot{\varphi}_i = L_i^0 - k_i \dot{\varphi}_i + m_i \varepsilon_i \ddot{x} \sin \varphi_i \quad (i = 1, 2), \quad (8)$$

$$M \ddot{x} = -cx + \sum_{i=1}^2 m_i \varepsilon_i (\dot{\varphi}_i^2 \cos \varphi_i + \ddot{\varphi}_i \sin \varphi_i), \quad (9)$$

$$M \triangleq M_0 + m_1 + m_2; \quad I_i \triangleq J_i + m_i \varepsilon_i^2.$$

Here J_i, m_i, ε_i stand, respectively, for the moment of inertia, the mass and the eccentricity of the i th rotor, L_i^0, k_i are the rotating torque and the friction constant of the i th motor, M_0 is the mass of the platform and c is the spring constant.

Although Eqs. (8) and (9) cannot be solved analytically, an approximation to the solution is given by a singular perturbation technique [Sperling *et al.*, 1997], referred to as the method of *direct partition of motions* (DPM) [Blekhman, 2000]. It is supposed (and confirmed experimentally) that around a synchronous manifold the angular velocities of the rotors are almost constant in the sense that $\dot{\varphi}_i \approx \Omega$ and $\ddot{\varphi}_i \approx 0$, and their synchronous motion leads to nearly harmonic oscillations of the platform. The residual $\varphi_i(t) - \Omega t$ is then split into the sum of “slow” and “fast” variables

$$\begin{aligned} \varphi_i(t) - \Omega t &= \alpha_i(t) + \psi_i(t, \Omega t), \\ \frac{1}{2\pi} \int_0^{2\pi} \psi_i(t, \vartheta) d\vartheta &= 0. \end{aligned} \quad (10)$$

Here $|\dot{\alpha}_i + \dot{\psi}_i|, |\ddot{\alpha}_i + \ddot{\psi}_i| \ll 1$. Substituting $\varphi_i \approx \Omega t + \alpha_i, \dot{\varphi}_i \approx \Omega, \ddot{\varphi}_i \approx 0$ into (9), the platform's motion is then approximated [Sperling *et al.*, 1997] as follows

$$x(t) \approx A_{xx} \sum_{i=1}^2 f_i \cos(\Omega t + \alpha_i(t)), \quad (11)$$

$$A_{xx} \triangleq \frac{1}{M(\omega^2 - \Omega^2)}, \quad \omega^2 \triangleq \frac{c}{M}.$$

The approximation (11) is then substituted to (8). Splitting fast and slow variables in the resulting equation (by averaging over the “fast time” Ωt)

yields in the dynamics for $\dot{\alpha}_i$ [Sperling *et al.*, 1997]

$$\begin{aligned} I_1 \ddot{\alpha}_1 + k_1 \dot{\alpha}_1 &= k_1(\Omega_1 - \Omega) - A \sin(\alpha_1 - \alpha_2), \\ I_2 \ddot{\alpha}_2 + k_2 \dot{\alpha}_2 &= k_2(\Omega_2 - \Omega) + A \sin(\alpha_1 - \alpha_2), \end{aligned} \quad (12)$$

$$\Omega_i \triangleq \frac{L_i^0}{k_i}, \quad A \triangleq \frac{1}{2} A_{xx} f_1 f_2.$$

A natural assumption that (12) should have a static solution $\alpha_i \equiv \text{const}$ (corresponding to the ideal harmonic motion) leads to the condition $k_1(\Omega_1 - \Omega) + k_2(\Omega_2 - \Omega) = 0$, that is,

$$\Omega = \frac{k_1 \Omega_1 + k_2 \Omega_2}{k_1 + k_2}. \quad (13)$$

Under the assumption (13), the slow terms $\alpha_i(t)$ obey the following nonlinear equations

$$\begin{cases} I_1 \ddot{\alpha}_1 + k_1 \dot{\alpha}_1 + A \varphi(\alpha_1 - \alpha_2) = 0, \\ I_2 \ddot{\alpha}_2 + k_2 \dot{\alpha}_2 - A \varphi(\alpha_1 - \alpha_2) = 0, \end{cases} \quad (14)$$

$$\varphi(\sigma) \triangleq \sin \sigma - \frac{\beta}{A}, \quad \beta \triangleq \frac{k_1 k_2}{k_1 + k_2} (\Omega_1 - \Omega_2).$$

Resolving (14) with respect to $\dot{\alpha}_i$, one obtains

$$\begin{aligned} \dot{\alpha}_j(t) &= \dot{\alpha}_j(0) e^{-r_j t} + (-1)^j A \int_0^t \frac{1}{I_j} e^{-r_j(t-\tau)} \\ &\quad \times \varphi(\alpha_1(\tau) - \alpha_2(\tau)) d\tau \quad (j = 1, 2) \end{aligned} \quad (15)$$

with $r_j = \frac{k_j}{I_j}$. Therefore the deviation $\sigma(t) = \alpha_1(t) - \alpha_2(t)$ is a solution to (1) with

$$\begin{aligned} R &= 0, \quad h = 0, \\ b(t) &= \dot{\alpha}_1(0) e^{-r_1 t} - \dot{\alpha}_2(0) e^{-r_2 t}, \\ \Gamma(t) &= \frac{A}{I_1} e^{-r_1 t} - \frac{A}{I_2} e^{-r_2 t}. \end{aligned} \quad (16)$$

The (approximate) synchronization of rotors corresponds to the convergence $\sigma(t) \rightarrow \text{const}$ and $\dot{\sigma}(t) \rightarrow 0$ as $t \rightarrow +\infty$. Notice that Eqs. (14) resemble the pendulum equation (6), however, the deviation $\sigma(t)$ does not satisfy (6) [in fact, (14) can be transformed into a third-order ODE for $\sigma(t)$].

2.2.3. Phase-locked loop (PLL)

The minimal structure of a PLL circuit is shown in Fig. 3(a). The three cornerstone elements are the *phase detector* (comparator), the bandpass *loop filter* and the *voltage control oscillator*, which has to

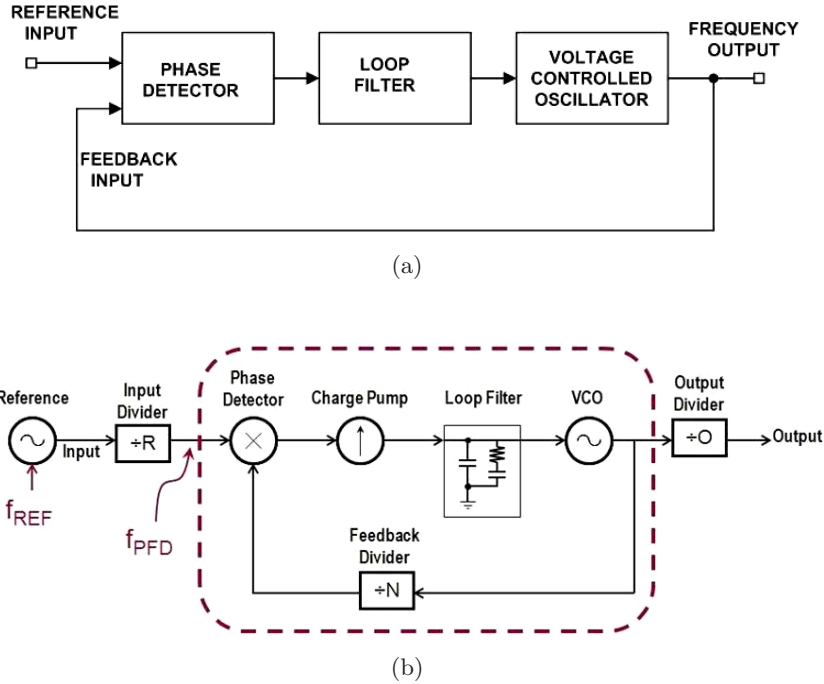

Fig. 3. Illustration of Sec. 2.2.3: the “minimal” PLL versus a more general synchronization circuit.

be synchronized with the reference oscillatory signal. In practice, synchronization circuits often have more intricate structures, including e.g. frequency dividers, charge pumps to raise or lower voltage, etc. [Fig. 3(b)].

The input to PLL is produced by some *reference oscillator* (RO), which is usually considered to be harmonic with some fixed frequency $\omega_{RO} > 0$, that is, $f_{in}(t) = \sin \sigma_{RO}(t)$, where $\sigma_{RO}(t) = \omega_{RO}t + \theta_0$. The VCO’s output $f_{out}(t) = \sin \sigma_{VCO}(t)$ has to be (asymptotically) *synchronized* with the RO in the sense that

$$\begin{aligned} \sigma(t) &\triangleq \sigma_{RO}(t) - \sigma_{VCO}(t) \xrightarrow{t \rightarrow \infty} \sigma_* = \text{const}, \\ \sigma(t) &= \omega_{RO} - \dot{\sigma}_{VCO}(t) \xrightarrow{t \rightarrow \infty} 0. \end{aligned} \tag{17}$$

The desired behavior (17) is referred to as the phase and frequency *locking*. To reach it, the feedback control loop [Fig. 3(a)] is designed, consisting of the phase detector and loop filter. The phase detector (comparator) receives the input and output signals $f_{in}(t), f_{out}(t)$, and returns a sum of “slowly” changing functions, represented as $F(\sigma(t))$, and a “fast” oscillatory signal, which is then cancelled by the low-pass filter. In analog PLLs, the simplest detector of this kind computes the product

$$f_{in}(t)f_{out}(t) = \frac{1}{2} \cos(\sigma(t)) - \frac{1}{2} \cos(\sigma_{VCO}(t) + \sigma_{RO}(t)).$$

To simplify modeling, it is typically assumed that the filter perfectly rejects high-frequency components of the detector’s output, and only the “slow” part of this output $F(\sigma(t))$ (*phase error*) influences the VCO; here $F(\sigma)$ is typically a 2π -periodic function of the phase. Typically, the VCO’s controlled frequency is the sum of the free run (open-loop) value ω_{VCO}^0 and a term, proportional to the filtered phase error, that is,

$$\dot{\sigma}_{VCO}(t) := \omega_{VCO}^0 + Le(t),$$

$$e(t) = -\rho_F F(\sigma(t)) + \int_0^t g_F(t-s)F(\sigma(s))ds, \tag{18}$$

where L is a control gain and $\rho_F = \text{const}$, $g_F(\cdot) \in L_1[0, \infty)$ are the filter’s characteristics.

Combining (18) with the definition of $\sigma(t)$ in (17), one arrives at

$$\begin{aligned} \dot{\sigma}(t) &= \underbrace{(\omega_{RO} - \omega_{VCO}^0)}_{\beta_F \triangleq} + \underbrace{L\rho_F}_{R \triangleq} F(\sigma(t)) \\ &\quad - \int_0^t \underbrace{Lg_F(t-s)}_{\Gamma(t-s) \triangleq} F(\sigma(s))ds. \end{aligned} \tag{19}$$

In the case of phase and frequency locking (17), the steady phase error $\beta \triangleq F(\sigma_*)$ can be found

from

$$\beta_F + L\rho_F\beta - \beta \int_0^t Lg_F(t-s)ds \xrightarrow{t \rightarrow \infty} 0$$

$$\Leftrightarrow \beta = \frac{\beta_F}{-R + \int_0^\infty \Gamma(s)ds}. \quad (20)$$

It is convenient to introduce a shifted detector's characteristics $\varphi(\sigma) \triangleq F(\sigma) - \beta$, vanishing at the equilibrium points σ_* . For $\varphi(\cdot)$ defined in this way, Eq. (19) shapes into (1), where

$$b(t) = \beta \int_t^\infty \Gamma(s)ds$$

$$= \beta \left(\int_0^\infty \Gamma(s)ds - \int_0^t \Gamma(t-s)ds \right)$$

$$\stackrel{(19),(20)}{=} \beta_F + \beta R - \beta \int_0^t \Gamma(t-s)ds$$

and Γ, R are defined in (19) and $h = 0$. A more general model (1) with $h > 0$ corresponds to the *delayed* feedback case, where the detector's output is $F(\sigma(t-h))$. In this case, $\Gamma(t) = 0$ for $t < h$ and $b(t)$ depends on the initial function $\sigma^0(\cdot)$ from (2); the relevant computations are similar to the case $h = 0$ and omitted here. It should be noticed that even in the absence of delays, the model of PLL can be infinite-dimensional due to the use of intricate filters with nonrational transfer function. It has been shown in [Yu & Wang, 2013; Tripathy *et al.*, 2015] that *fractional-order* filters can drastically reduce locking time and increase the capture range of a PLL, although robustness to noises can deteriorate.

Remark 2.1. One may notice that the *frequency deviation* $\beta_F = \omega_{RO} - \omega_{VCO}^0$ substantially influences the nonlinearity $\varphi(\sigma)$, which in turn determines the set of the system's equilibria and the overall system's behavior. The excellent survey [Leonov *et al.*, 2015a] provides a detailed analysis of the interrelation between the value of β_F and the PLL's behavior² and considers, in particular, the three sets of the values $\{\beta_F\}$, referred to as the *hold-in*, *pull-in* and *lock-in* ranges. The hold-in range is the set of β_F , for which the system has at least one (locally) asymptotically stable equilibrium; in general, this

set of parameters is disconnected and may consist of several disjoint intervals. Its subset, called pull-in (or capture) range is constituted by values β_F , for which the PLL system is gradient-like (each solution converges to one of the equilibria³). The lock-in range (omitting some technical details) consists of the deviations β_F , for which the PLL is gradient-like and free of cycle slipping. In this work, we do not consider the problem of local stability and focus on the global convergence (Sec. 3) and cycle slipping (Sec. 4). Dealing with PLL circuits, the criteria from Secs. 3 and 4 can be applied to estimate the pull-in and lock-in ranges of the system, being an important problem in radio engineering. The explicit estimates, however, are beyond the scope of this work and will be addressed in our future papers.

2.3. A frequency-domain inequality and integral quadratic constraint

In this subsection, we formulate a technical lemma, used throughout the paper to establish asymptotic properties of the system (1). We start with introducing the set of diagonal $l \times l$ matrices and its subsets

$$\mathcal{D}^l \triangleq \{d = \text{diag}\{d_1, \dots, d_l\} : d_j \in \mathbb{R} \forall j\},$$

$$\mathcal{D}_+^l \triangleq \{d \in \mathcal{D}^l : d > 0\},$$

$$\overline{\mathcal{D}}_+^l \triangleq \{d \in \mathcal{D}^l : d \geq 0\},$$

$$\mathcal{M}_1 \triangleq \{\alpha_1 = \text{diag}\{\alpha_{11}, \dots, \alpha_{1l}\}, \alpha_{1j} \leq \mu_{1j} \forall j\},$$

$$\mathcal{M}_2 \triangleq \{\alpha_2 = \text{diag}\{\alpha_{21}, \dots, \alpha_{2l}\}, \alpha_{2j} \geq \mu_{2j} \forall j\}.$$

(21)

[where μ_{1j}, μ_{2j} are defined in (4)]. We introduce the *transfer function* of the linear part from ξ to $(-\dot{\sigma})$:

$$K(p) \triangleq -\text{Re}^{-ph} + \int_0^\infty \Gamma(t)e^{-pt}dt,$$

$$p \in \mathbb{C}, \quad \text{Re } p > -r. \quad (22)$$

In the subsequent analysis we use the *frequency-domain* condition, involving matrix parameters $\varkappa, \varepsilon, \tau, \delta, \alpha_1, \alpha_2 \in \mathcal{D}^l, \det \alpha_1 \det \alpha_2 \neq 0$.

²In [Leonov *et al.*, 2015a], the frequency deviation is denoted by $\omega_\Delta^{\text{free}}$.

³In [Leonov *et al.*, 2015a], this property is called the global asymptotic stability of the system.

Hereinafter, i stands for the imaginary unit, $i^2 = -1$.

$$\begin{aligned} \Pi(\omega) &:= \operatorname{Re}\{\varkappa K(i\omega) - K^*(i\omega)\varepsilon K(i\omega) \\ &\quad - [K(i\omega) + i\omega\alpha_1^{-1}]^* \tau [K(i\omega) + i\omega\alpha_2^{-1}]\} \\ &\quad - \delta \geq 0. \end{aligned} \tag{23}$$

Most typically, we will have $\alpha_1 \in \mathcal{M}_1$ and $\alpha_2 \in \mathcal{M}_2$, $\delta > 0$ and $\varepsilon, \tau \geq 0$. The value of each α_{ij} may be either a number or $\pm\infty$. In the latter case we take $\alpha_{ij}^{-1} := 0$. The stability criteria, obtained in this paper, are based on the following *integral quadratic constraint*, guaranteed by (23).

Lemma 1. *Let (23) hold for all $\omega \in \mathbb{R}$ and some matrices $\varkappa, \varepsilon, \tau, \delta, \alpha_1, \alpha_2 \in \mathcal{D}^l$, $\det \alpha_1 \det \alpha_2 \neq 0$. Then for any solution of (1), the following family of quadratic functionals*

$$\begin{aligned} I_T[w(\cdot)] &\triangleq \int_0^T \{\dot{\sigma}(t)^* \varkappa \xi(t) + \xi(t)^* \delta \xi(t) + \dot{\sigma}(t)^* \varepsilon \dot{\sigma}(t) \\ &\quad + (\dot{\sigma}(t) - \alpha_1^{-1} \dot{\xi}(t))^* \tau (\dot{\sigma}(t) - \alpha_2^{-1} \dot{\xi}(t))\} dt \\ w(\cdot) &\triangleq [\dot{\sigma}(\cdot)^\top, \xi(\cdot)^\top, \dot{\xi}(\cdot)^\top]^\top, \end{aligned} \tag{24}$$

is bounded in T . More formally, there exists a constant \mathfrak{q} , depending on the matrices $\varkappa, \delta, \varepsilon, \tau, \alpha_i$, the constants $C, r, \bar{\varphi}_j, \mu_{1j}, \mu_{2j}$ from Assumptions 1 and 2 and the initial conditions (2), such that

$$I_T[\dot{\sigma}(\cdot), \xi(\cdot), \dot{\xi}(\cdot)] \leq \mathfrak{q}, \quad \forall T \geq 0. \tag{25}$$

The technical proof of Lemma 1 is given in Appendix (in fact, we prove a more general result, dealing with a broad class of quadratic functionals). It should be noticed that from this proof, an explicit formula for \mathfrak{q} can be obtained, being however somewhat ‘‘cumbersome’’. It should be noticed that the results on asymptotic behavior of the system, presented in this paper, do not employ the exact value of \mathfrak{q} , which, however, is needed to get the estimates for the transient behavior of the system’s solutions (namely, the number of slipped cycles). For some special solutions, a general estimate for the functional I_T can be simplified, as discussed in Remarks A.1 and A.2 in the Appendix.

3. The Global Convergence (Phase Locking) Criteria

In this section, we derive the criteria, ensuring convergence of all solutions to equilibria points. This property is often referred to as the *gradient-like*

behavior [Leonov, 2006; Duan *et al.*, 2007] or, when dealing with synchronization circuits, *phase locking*. In fact, the following stronger property will be established.

Definition 3.1. We call a solution of (1) L_2 -convergent if the function $\xi(t) = \varphi(\sigma(t))$ is L_2 -summable.

The following simple lemma demonstrates that any L_2 -convergent solution converges to an equilibrium.

Lemma 2. *Suppose that $|\xi(\cdot)| \in L_2[0, \infty)$. Then $\dot{\sigma}(t) \rightarrow 0$ and $\sigma(t) \xrightarrow[t \rightarrow \infty]{} \sigma^0$, where $\varphi(\sigma^0) = 0$.*

Proof. Assumption 1 implies that $\dot{\sigma}$ is bounded, and hence $\sigma(\cdot)$ is uniformly continuous. The same holds for $\xi(t) = \varphi(\sigma(t))$ since $\dot{\xi} = \varphi'(\sigma)\dot{\sigma}$ and $\varphi'(\sigma)$ is bounded. Using the standard Barbalat lemma [Popov, 1973], we have $\xi(t) = \varphi(\sigma(t)) \rightarrow 0$ as $t \rightarrow \infty$. Since $\varphi(\cdot)$ has isolated equilibria points, this implies that $\sigma(t) \rightarrow \sigma^0$, where $\varphi(\sigma^0) = 0$. Assumption 1 and (1) imply that $\dot{\sigma}(t) \rightarrow 0$ as $t \rightarrow \infty$ (for an exponentially stable linear system, the input vanishing as $t \rightarrow \infty$ corresponds to the vanishing output). ■

Our simplest criterion for L_2 -convergence deals with a special case where each scalar nonlinearity $\varphi_j(\cdot)$ has zero average over a period (recall that the periods Δ_j may differ). Such nonlinearities are featured by the following simple property.

Proposition 1. *For any locally summable Δ -periodic function $\psi : \mathbb{R} \rightarrow \mathbb{R}$ such that $\int_0^\Delta \psi(\zeta) d\zeta = 0$ one has*

$$\left| \int_{s_1}^{s_2} \psi(\zeta) d\zeta \right| \leq \int_0^\Delta |\psi(\zeta)| d\zeta \quad \forall s_1, s_2 \in \mathbb{R}. \tag{26}$$

Proof. Since ψ is Δ -periodic, for any $s \in \mathbb{R}$ and integer k , one has $\int_s^{s+k\Delta} \psi(\zeta) d\zeta = k \int_0^\Delta \psi(\zeta) d\zeta = 0$. Let $s_2 - s_1 = k\Delta + \Delta'$, where k is an integer and $\Delta' \in [0, \Delta)$. Then, using the periodicity, one has

$$\begin{aligned} \left| \int_{s_1}^{s_2} \psi(\zeta) d\zeta \right| &= \left| \int_{s_1}^{s_1+\Delta'} \psi(\zeta) d\zeta + \int_{s_1+\Delta'}^{s_2} \psi(\zeta) d\zeta \right| \\ &= \left| \int_0^{\Delta'} \psi(\zeta) d\zeta \right| \leq \int_0^\Delta |\psi(\zeta)| d\zeta. \end{aligned}$$

■

Lemma 3. Suppose that $\int_0^{\Delta_j} \varphi_j(\zeta) d\zeta = 0 \forall j$ and the frequency-domain inequality (23) holds for some $\varkappa \in \mathcal{D}^l, \delta \in \mathcal{D}_+^l, \tau, \varepsilon \in \overline{\mathcal{D}}_+^l$. Then any solution of the system (1) is L_2 -convergent.

Proof. In accordance with Lemma 1, for any $T > 0$ the following inequality holds

$$\begin{aligned} \int_0^T \xi(t)^\top \delta \xi(t) dt &= \sum_j \delta_j \int_0^T |\xi_j(t)|^2 dt \\ &\leq \mathfrak{q} - \int_0^T \dot{\sigma}^\top \varkappa \xi(t) dt - \int_0^T \left[\underbrace{\dot{\sigma}^\top \varepsilon \dot{\sigma}(t)}_{\geq 0} + \underbrace{(\dot{\sigma}(t) - \alpha_1^{-1} \dot{\xi}(t))^* \tau (\dot{\sigma}(t) - \alpha_2^{-1} \dot{\xi}(t))}_{\geq 0} \right] dt \\ &\leq \mathfrak{q} - \sum_j \varkappa_j \underbrace{\int_0^T \dot{\sigma}_j(t) \varphi_j(\sigma_j(t)) dt}_{= \int_{\sigma_j(0)}^{\sigma_j(T)} \varphi_j(\zeta) d\zeta}. \end{aligned} \tag{27}$$

Proposition 1 entails that the right-hand side of (27) is uniformly bounded over $T > 0$. Passing to the limit $T \rightarrow \infty$ and recalling that $\delta > 0$, the solution is L_2 -convergent. ■

3.1. The Bakaev–Guzh procedure and general L_2 -convergence criteria

As can be seen from examples, considered in Sec. 2.2, often the condition of zero average from Lemma 3 fails to hold (e.g. it is not valid for $\varphi(\sigma) = c + \sin \sigma, c \neq 0$). To get rid of this restrictive assumption, the so-called “Bakaev–Guzh procedure” [Bakaev & Guzh, 1965] can be used, decomposing the nonlinearities as

$$\varphi_j(\zeta) = y_j(\zeta) + \nu_j v_j(\zeta) |\varphi_j(\zeta)|. \tag{28}$$

Here $v_j(\zeta) > 0$ is some specially chosen Δ_j -periodic function, and the multiplier ν_j is chosen in a way that

$$\int_0^{\Delta_j} y_j(\zeta) d\zeta = 0 \Leftrightarrow \nu_j = \frac{\int_0^{\Delta_j} \varphi_j(\zeta) d\zeta}{\int_0^{\Delta_j} v_j(\zeta) |\varphi_j(\zeta)| d\zeta}. \tag{29}$$

Introducing the auxiliary function

$$\xi_j(t) = \varphi_j(\sigma_j(t)),$$

one has

$$\xi_j(t) = y_j(\sigma_j(t)) + \nu_j v_j(\sigma_j(t)) |\xi_j(t)|.$$

By noticing that

$$\dot{\xi}_j(t) = \varphi'_j(\sigma_j(t)) \dot{\sigma}_j(t),$$

the quadratic functional (24) can be decomposed as follows

$$\begin{aligned} I_T[w(\cdot)] &= \sum_{j=1}^l \varkappa_j \int_0^T \dot{\sigma}_j(t) y_j(\sigma_j(t)) dt \\ &\quad + \int_0^T \sum_j [\varkappa_j \nu_j \dot{\sigma}_j(t) v_j(\sigma_j(t)) |\xi_j(t)| \\ &\quad + \delta_j |\xi_j(t)|^2 + \varepsilon_j (1 + \varepsilon_j^{-1} \tau_j \Phi_j(\sigma_j(t))^2) \\ &\quad \times |\dot{\sigma}_j(t)|^2] dt, \end{aligned} \tag{30}$$

$$\Phi_j(\sigma_j) \triangleq \sqrt{(1 - \alpha_{1j}^{-1} \varphi'_j(\sigma_j))(1 - \alpha_{2j}^{-1} \varphi'_j(\sigma_j))}. \tag{31}$$

Proposition 1 implies, thanks to (29), that the first term in (30) is a bounded function of $T \geq 0$ (where the bound depends, of course, on the choice of the specific $v_j(\cdot)$). Choosing now $v_j(\zeta) = \sqrt{1 + \varepsilon_j^{-1} \tau_j \Phi_j(\zeta)^2}$ and calculating ν_j in accordance with (29), the expression under the second integral in (30) becomes a *quadratic* form of the variables ξ_j and $\dot{\sigma}_j v_j(\sigma_j)$, which appear to be positive definite under additional restriction on the parameters. We now formulate the corresponding result.

Theorem 1. Suppose there exist diagonal matrices $\varkappa \in \mathcal{D}^l, \tau \in \overline{\mathcal{D}}_+^l, \varepsilon, \delta \in \mathcal{D}_+^l, \alpha_1 \in \mathcal{M}_1, \alpha_2 \in \mathcal{M}_2$

such that the frequency-domain inequality (23) holds and the following algebraic inequalities are valid

$$2\sqrt{\varepsilon_j \delta_j} > |\varkappa_j \bar{\nu}_j|, \quad \bar{\nu}_j \triangleq \frac{\int_0^{\Delta_j} \varphi_j(\zeta) d\zeta}{\int_0^{\Delta_j} |\varphi_j(\zeta)| \sqrt{1 + \varepsilon_j^{-1} \tau_j \Phi_j(\zeta)^2} d\zeta}, \quad \forall j = 1, \dots, l. \tag{32}$$

Then any solution of (1) is L_2 -convergent.

Proof. Decomposing the nonlinearities $\varphi_j(\sigma_j)$ as in (28), where

$$v_j(\zeta) = \sqrt{1 + \varepsilon_j^{-1} \tau_j \Phi_j(\zeta)^2}, \quad \nu_j = \bar{\nu}_j, \tag{33}$$

the multiplier ν_j satisfies (29). Due to Proposition 1, the first sum in (30) is uniformly bounded over all $T \geq 0$. Due to the inequalities (32), $4\varepsilon_j \delta_j > \varkappa_j^2 \nu_j^2$, and hence there exists a constant $\vartheta > 0$ such that

$$\sum_j \left[\varkappa_j \nu_j \dot{\sigma}_j v_j(\sigma_j) |\xi_j| + \delta_j |\xi_j|^2 + \varepsilon_j |\dot{\sigma}_j|^2 \underbrace{(1 + \varepsilon_j^{-1} \tau_j \Phi_j(\sigma_j)^2)}_{=|v_j(\sigma_j)|^2} \right] \geq \sum_j \vartheta (|\xi_j|^2 + |\dot{\sigma}_j v_j(\sigma_j)|^2) \geq \vartheta |\xi|^2. \tag{34}$$

Using the inequality (25) and passing to the limit as $T \rightarrow \infty$, (30) implies that $|\xi(\cdot)| \in L_2[0, \infty)$. ■

If $\int_0^{\Delta_j} \varphi_j(\zeta) d\zeta = 0$, then (32) holds for any $\varepsilon_j, \delta_j > 0, \tau_j \geq 0, \varkappa_j \in \mathbb{R}$, so the general criterion from Theorem 1 reduces to Lemma 3 (with the only difference that Lemma 3 allows to choose $\varepsilon_j = 0$). In general, the analytic computation of the integral in (32) may be troublesome, however, some estimates can be used. For instance, (32) is implied by simpler yet more conservative inequalities

$$2\sqrt{\varepsilon_j \delta_j} > \left| \frac{\varkappa_j \int_0^{\Delta_j} \varphi_j(\zeta) d\zeta}{\int_0^{\Delta_j} |\varphi_j(\zeta)| d\zeta} \right|, \quad \forall j = 1, 2, \dots, l. \tag{35}$$

Notice that the condition (35) does not involve τ , and the only restriction on this parameter is the frequency-domain inequality (23). Choosing $\tau = 0$, the frequency-domain inequality (23) becomes independent of α_1 and α_2 , in other words, the slope restriction $\varphi_j(\sigma_j)$ is completely ignored. As shown in Example 3.1 such a condition may be restrictive; in particular, it cannot be valid if $R = 0$ and thus $K(\omega) \rightarrow 0$ as $\omega \rightarrow \pm\infty$. However, τ cannot be chosen very large since otherwise (23) is violated at $\omega = 0$.

The Bakaev–Guzh decomposition, providing the positivity of the second term in (30) is, obviously, nonunique. An alternative convergence criterion can be obtained, considering a convex

combination of two decompositions (28), with $v_{j1}(\zeta) \equiv 1, v_{j0}(\zeta) = \Phi_j(\zeta)$ and the corresponding multipliers ν_{j1}, ν_{j0} from (29):

$$\begin{aligned} \varphi_j(\zeta) &= a_j (y_{j1}(\zeta) + \nu_{j1} |\varphi_j(\zeta)|) + (1 - a_j) \\ &\quad \times (y_{j0}(\zeta) + \nu_{j0} \Phi_j(\zeta) |\varphi_j(\zeta)|) \\ &= y_j(\zeta) + \nu_j v_j(\zeta), \\ y_j(\zeta) &= a_j y_{j1}(\zeta) + (1 - a_j) y_{j0}(\zeta), \\ v_j &= a_j \nu_{j1} + (1 - a_j) \nu_{j0} \Phi_j(\zeta), \\ \nu_j &= 1, \quad a_j \in [0, 1]. \end{aligned} \tag{36}$$

Substituting this into (30), the second integrand becomes the quadratic form of $\dot{\sigma}_j, |\xi_j|, \dot{\sigma}_j \Phi_j(\sigma_j)$ as follows

$$\begin{aligned} \sum_j & [\varepsilon_j \dot{\sigma}_j^2 + \tau_j (\dot{\sigma}_j \Phi_j(\sigma_j))^2 + \delta_j |\xi_j|^2 + a_j \varkappa_j \nu_{j1} \dot{\sigma}_j |\xi_j| \\ & + (1 - a_j) \varkappa_j \nu_{j0} |\xi_j| (\dot{\sigma}_j \Phi_j(\sigma_j))]. \end{aligned}$$

Retracing the arguments in the proof of Theorem 1, all solutions are L_2 -convergent if the latter quadratic form is positive definite. We arrive at the following result.

Theorem 2. *Suppose there exist matrices $\varkappa \in \mathcal{D}^l, \delta, \varepsilon, \tau \in \mathcal{D}_+^l, \alpha_1 \in \mathcal{M}_1, \alpha_2 \in \mathcal{M}_2$ and the scalars $a_j \in [0, 1]$ such that (23) holds and the following*

matrix inequalities hold for $j = 1, \dots, l$,

$$\begin{pmatrix} \varepsilon_j & \frac{\varkappa_j a_j \nu_{j1}}{2} & 0 \\ \frac{\varkappa_j a_j \nu_{j1}}{2} & \delta_j & \frac{\varkappa_j (1 - a_j) \nu_{j0}}{2} \\ 0 & \frac{\varkappa_j (1 - a_j) \nu_{j0}}{2} & \tau_j \end{pmatrix} > 0,$$

$$\nu_{j0} \triangleq \frac{\int_0^{\Delta_j} \varphi_j(\zeta) d\zeta}{\int_0^{\Delta_j} |\varphi_j(\zeta)| |\Phi_j(\zeta)| d\zeta},$$

$$\nu_{j1} \triangleq \frac{\int_0^{\Delta_j} \varphi_j(\zeta) d\zeta}{\int_0^{\Delta_j} |\varphi_j(\zeta)| d\zeta}.$$

(37)

Then all solutions of the system (1) are L_2 -convergent.

Choosing $a_j = 1$ and $\tau > 0$, (37) in fact reduces to (35). For $a_j = 0$, (37) reduces to

$$2\sqrt{\delta_j \tau_j} > |\varkappa_j \nu_{j0}| \quad \forall j = 1, \dots, l.$$

Remark 3.1. For the Bakaev–Guzh decomposition (28) with ν_j defined by (29), one has

$$\begin{aligned} & \int_0^{\Delta_j} |y_j(\zeta)| d\zeta \\ & \leq \int_0^{\Delta_j} |\varphi_j(\zeta)| d\zeta + |\nu_j| \int_0^{\Delta_j} |\varphi_j(\zeta)| |\nu_j(\zeta)| d\zeta \\ & \stackrel{(29)}{=} s_j \triangleq \int_0^{\Delta_j} |\varphi_j(\zeta)| d\zeta + \left| \int_0^{\Delta_j} \varphi_j(\zeta) d\zeta \right|. \end{aligned}$$

(38)

Using (25), (30), (26) (with $\psi = y_j$) and (38), it is possible to obtain an explicit estimate of the norm $\|\xi(\cdot)\|_{L_2[0,\infty)}$ provided that the assumptions of Theorem 1 or 2 are valid.

3.2. Numerical examples: The dynamics of PLLs

The examples deal with the scalar case ($l = 1$), where the inequality (23) is especially easy to check.

To demonstrate the stability criteria, we confine ourselves to the equations of second order, however, higher-order PLL circuits [Leonov & Smirnova, 1980] can also be examined by our methods.

Example 3.1. Consider the mathematical pendulum:

$$\ddot{\sigma} + a\dot{\sigma} + (\sin \sigma - \beta) = 0, \quad a > 0, \quad \beta \in (0, 1). \quad (39)$$

Due to (7), this equation is equivalent to a PLL whose loop filter has the transfer function

$$K(p) = \frac{T}{Tp + 1}, \quad T = a^{-1} > 0. \quad (40)$$

Using Theorem 2 with $\varkappa = 1$, $\alpha_{11} = -\infty$, $\alpha_{21} = 1$, it is possible to estimate the set of the coefficients $\{(T, \beta)\}$, $T, \beta > 0$, for which all solutions of the system (39) converge. In Fig. 4, we compare the domain in the parameter space, where the convergence is ensured by Theorem 2, with the exact convergence domain, computed in [Belyustina *et al.*, 1970] by using qualitative-numerical methods (the convergence domains lie under the curves **T2** and **Q** respectively).

Example 3.2. Consider a PLL with a proportional integral low-pass filter and a sine-shaped characteristic of phase frequency detector. The transfer function of the linear part and the nonlinearity are, respectively,

$$K(p) := T \frac{mTp + 1}{Tp + 1}, \quad \varphi(\sigma) = \sin \sigma - \beta,$$

$$\beta \in (0, 1), \quad T > 0. \quad (41)$$

Choosing $m = 0.2$ as in [Pervachev, 1962], Fig. 5 illustrates the dependencies between T^{-1} and β ,

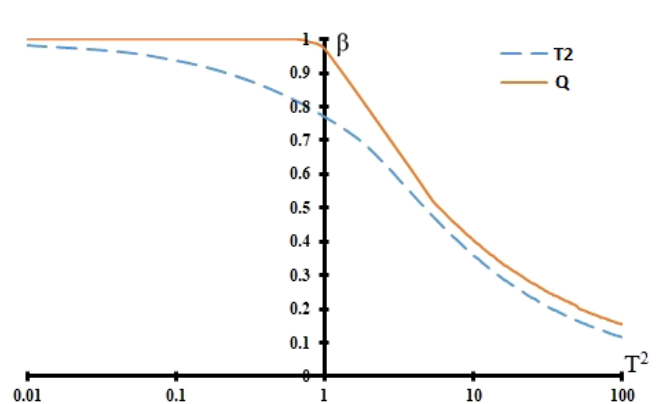

Fig. 4. The exact phase-locking domain for the system (39) versus its estimate from Theorem 2.

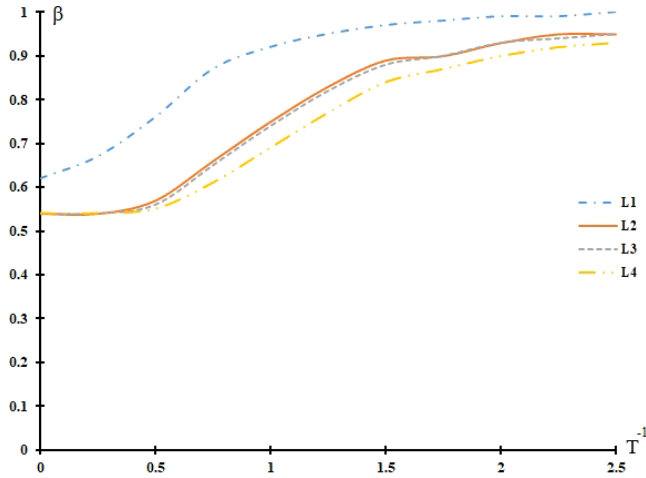

Fig. 5. Stability domains for the PLL system (41) with $m = 0.2$.

providing the solutions' convergence. The stability domain obtained by numerical solution of Eq. (1) on the plane (T^{-1}, β) is located under the curve $L1$ [Pervachev, 1962]. Other curves are the lower estimates of the boundary $L1$ received with the help of Theorems 1 and 2, choosing $\alpha_{21} = -\alpha_{11} = 1$ and fixing⁴ $\varkappa = 1$.

For $\tau = 0$, the condition (32) coincides with (35) and can be satisfied simultaneously with (23) only when $\beta < \beta_0 \approx 0.55$; here $T > 0$ can be arbitrary [Gel'fand *et al.*, 2004]. At the same time, the conditions (35) and (23) with $\tau > 0$ hold in fact for a much broader domain of parameters (T^{-1}, β) , lying under the curve $L4$ [Leonov *et al.*, 1996b]. As we have seen, (35) in the case where $\tau > 0$ is a special case of (37) with $a_1 = 1$. Using the

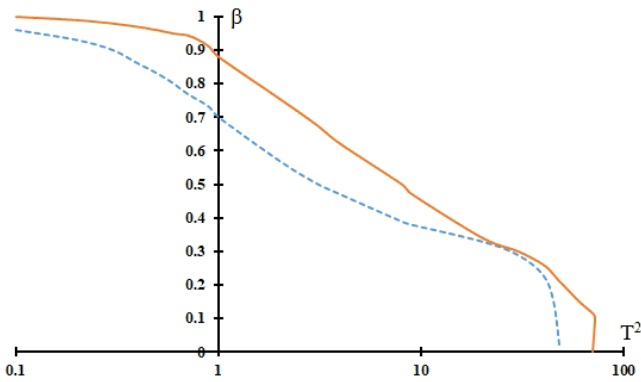

Fig. 6. Stability domains for the PLL system with time delay (42).

criterion from Theorem 2 and varying the parameter $a_1 \in [0, 1]$ in (37), a broader set of parameters bounded by curve $L3$ is obtained [Perkin *et al.*, 2009]. Theorem 1 gives curve $L2$, close to $L3$.

Example 3.3. Consider now a system similar to (41) with delayed feedback

$$K(p) := T \frac{0.2Tp + 1}{Tp + 1} e^{-ph}, \quad h = 0.1T. \quad (42)$$

Figure 6 illustrates the dependencies between T^2 and β . The solid line stands for the upper boundary of the stability region obtained by qualitative-numerical methods in [Belustina, 1992]. For the region of parameters under the dashed line, the stability is ensured by Theorem 2 (where we have fixed $\varkappa = |\alpha_1| = \alpha_2 = 1$ and varied $\varepsilon_1, \delta_1, \tau_1, a_1$). Theorem 1 in fact gives the same stability domain.

4. The Number of Slipped Cycles

The convergence criteria established in the previous section contain no information about the equilibrium a specific solution converges to. One may suppose that, choosing $\sigma(0)$ very close to an equilibrium point $\bar{\sigma}^0$, the convergence $\sigma(t) \xrightarrow[t \rightarrow \infty]{} \bar{\sigma}^0$ should take place. However, in spite of the exponential vanishing of $b(\cdot)$ in (1), this term may drive the trajectory beyond the equilibrium's $\bar{\sigma}^0$ basin of attraction, as illustrated by the usual pendulum (Sec. 2.2.1). If the initial angular velocity $\dot{\sigma}(0)$ is large, the pendulum can make several complete (360°) rotations around the suspension point before stopping at the stable equilibrium. In synchronization systems, such a behavior is referred to as the *cycle slipping* and considered to be undesirable, leading to deviations in the carrier frequency estimation and demodulation errors. Following the pioneering work [Viterbi, 1963], in communication engineering literature, cycle-slipping under stochastic noises has been extensively studied [Tausworthe, 1967; Ascheid & Meyr, 1982; Sancho *et al.*, 2014]. The main concern of these studies is to reveal the relations between the signal-to-noise ratio (SNR) and the expected number of slipped cycles. In this paper, we are confined to the aforementioned “deterministic” cycle-slipping problem, dealing with the estimate of the equilibrium to which a given solution converges.

⁴Obviously, the condition (23) remains unchanged, scaling all the parameters $\varkappa, \varepsilon, \delta, \tau$ by the same positive constant. Since $\varepsilon, \delta, \tau > 0$ and $T > 0$, (23) can hold only for $\varkappa > 0$. Hence, without loss of generality, we can assume that $\varkappa = 1$.

We start with a formal definition. Recall that $\Delta_j > 0$ stands for the period of $\varphi_j(\cdot)$.

Definition 4.1. Let $\sigma(\cdot) \in \mathbb{R}^l$ be a solution to (1). We say that its j th component $\sigma_j(\cdot)$ slips $k \geq 0$ cycles if there exists an instant $\hat{t} \geq 0$ such that $|\sigma_j(\hat{t}) - \sigma_j(0)| = k\Delta_j$, however $|\sigma_j(t) - \sigma_j(0)| < (k + 1)\Delta_j$ for any $t \geq 0$. In particular, the j th component of a solution slips *less* than $k \geq 1$ cycles if $|\sigma_j(t) - \sigma_j(0)| < k\Delta_j$.

Since the solution to (1) is uniformly bounded, each component σ_j slips some finite number of cycles $k_j \geq 0$. We are interested in obtaining explicit estimates of these numbers, assuming that the convergence conditions from the previous section hold. This problem may seem to be very different from the convergence problem, addressed in the previous section: the convergence is an *asymptotic* property of a solution, whereas the numbers of cycles k_j characterize its *transient* behavior. Nevertheless, it appears that Theorems 1 and 2 can give estimates for the numbers of slipped cycles, strengthening the algebraic conditions (32) and (37) respectively. To understand the idea, lying in the heart of these estimates, we consider the following simpler result, being in some sense a counterpart of Lemma 3 and giving a one-sided estimate for $\sigma_j(t)$.

Lemma 4. Assume that the (scalar) frequency-domain inequality (23) holds for some parameters $\varkappa \in \mathcal{D}^l$, $\delta \in \mathcal{D}^l_+$, $\varepsilon, \tau \in \overline{\mathcal{D}}^l_+$ and all $\omega \in \mathbb{R}$. Suppose also that $\int_0^{\Delta_j} \varphi_j(\zeta)d\zeta = 0$ for $j \neq j_0$ and

$$\begin{aligned} & (-1)^i \varkappa_{j_0} \int_0^{\Delta_{j_0}} \varphi_{j_0}(\zeta)d\zeta \\ & \geq \frac{\mathfrak{q} + \sum_{j \neq j_0} \int_0^{\Delta_j} |\varkappa_j \varphi_j(\zeta)|d\zeta}{k}, \end{aligned} \quad (43)$$

where $i \in \{0, 1\}$, $k > 0$ is integer, and \mathfrak{q} is the constant from (25). Then, the following inequality holds

$$(-1)^i [\sigma_{j_0}(t) - \sigma_{j_0}(0)] < k\Delta_{j_0} \quad \forall t \geq 0. \quad (44)$$

Proof. The proof follows the line of the proof of Lemma 3. Assume now, on the contrary, that $(-1)^i [\sigma_{j_0}(T) - \sigma_{j_0}(0)] = k\Delta_{j_0}$ for some $T \geq 0$. Since $\xi_{j_0}(t) \neq 0$ on $[0, T]$ and $\delta > 0$, one obtains that

$$0 < \mathfrak{q} - \sum_j \varkappa_j \int_0^T \dot{\sigma}_j(t) \varphi_j(\sigma_j(t)) dt$$

$$\begin{aligned} & = \mathfrak{q} - \sum_j \varkappa_j \int_{\sigma_j(0)}^{\sigma_j(T)} \varphi_j(\zeta)d\zeta \\ & = \mathfrak{q} - \sum_{j \neq j_0} \varkappa_j \int_{\sigma_j(0)}^{\sigma_j(T)} \varphi_j(\zeta)d\zeta \\ & \quad - \varkappa_{j_0} \int_{\sigma_{j_0}(0)}^{\sigma_{j_0}(T)} \varphi_{j_0}(\zeta)d\zeta \\ & \stackrel{(26)}{\leq} \mathfrak{q} + \sum_{j \neq j_0} \int_0^{\Delta_j} |\varkappa_j \varphi_j(\zeta)|d\zeta \\ & \quad - \underbrace{\varkappa_{j_0} \int_{\sigma_{j_0}(0)}^{\sigma_{j_0}(T)} \varphi_{j_0}(\zeta)d\zeta}_{=(-1)^i \varkappa_{j_0} k \int_0^{\Delta_{j_0}} \varphi_{j_0}(\zeta)d\zeta} \leq 0 \end{aligned} \quad (45)$$

and we arrive at the contradiction. Hence the inequality (44) is valid. ■

Although Lemma 4 cannot be directly used to estimate the number of slipped cycles, giving only a one-sided estimate (44) [obviously, (44) cannot hold for both $i = 0$ and $i = 1$] and being inapplicable to the case where $\int_0^{\Delta_{j_0}} \varphi_{j_0}(\zeta)d\zeta = 0$, it suggests the way how such an estimate can be obtained for the given component j_0 . Namely, for $j \neq j_0$ one needs to apply the Bakaev–Guzh procedure, which decomposes the function $\varphi_j(\zeta)$ in accordance with (28) and (29). For $j = j_0$, one has to consider a modified decomposition

$$\begin{aligned} \varphi_{j_0}(\zeta) & = y_{j_0}^{(0)}(\zeta) + \nu_{j_0}^{(0)} v_{j_0}^{(0)}(\zeta) |\varphi_{j_0}(\zeta)| \\ & = y_{j_0}^{(1)}(\zeta) + \nu_{j_0}^{(1)} v_{j_0}^{(1)}(\zeta) |\varphi_{j_0}(\zeta)|, \end{aligned} \quad (46)$$

where the choice of $\nu_{j_0}^{(i)}$, $i = 0, 1$, provides the following counterpart of (43) for the functions $y_j(\zeta)$

$$\begin{aligned} & (-1)^i \varkappa_{j_0} \int_0^{\Delta_{j_0}} y_{j_0}^{(i)}(\zeta)d\zeta \\ & = \frac{1}{k} \left(\mathfrak{q} + \sum_{j \neq j_0} |\varkappa_j| s_j \right) \\ & \stackrel{(38)}{\geq} \frac{1}{k} \left(\mathfrak{q} + \sum_{j \neq j_0} \int_0^{\Delta_j} |\varkappa_j y_j(\zeta)|d\zeta \right), \quad i = 0, 1. \end{aligned} \quad (47)$$

We now formulate the counterparts of Theorems 1 and 2, estimating the numbers of slipped cycles.

Theorem 3. *Under the assumptions of Theorem 1, assume that for some integer $k > 0$ and $j_0 \in \{1, \dots, l\}$*

$$\begin{aligned} \varkappa_{j_0} \neq 0, \quad 2\sqrt{\varepsilon_{j_0}\delta_{j_0}} > |\varkappa_{j_0}\nu_{j_0}^{(i)}|, \\ \nu_{j_0}^{(i)} \triangleq \frac{\int_0^{\Delta_{j_0}} \varphi_{j_0}(\zeta)d\zeta - \frac{(-1)^i}{k\varkappa_{j_0}} \left(\mathfrak{q} + \sum_{j \neq j_0} |\varkappa_j|s_j \right)}{\int_0^{\Delta_{j_0}} |\varphi_{j_0}(\zeta)|\sqrt{1 + \varepsilon_{j_0}^{-1}\tau_{j_0}\Phi_{j_0}(\zeta)^2}d\zeta} \\ \forall i = 0, 1. \end{aligned} \tag{48}$$

Here s_j are defined in (38) and Φ_j is from (31). Then the component $\sigma_{j_0}(\cdot)$ slips less than k cycles.

Notice that

$$\nu_{j_0}^{(0)} + \nu_{j_0}^{(1)} = 2\bar{\nu}_{j_0},$$

where $\bar{\nu}_j$ is defined in (32). In other words, the conditions (48) strengthen (32) for $j = j_0$ [and coincide with (32) as $k \rightarrow \infty$].

Proof. Following the proof of Theorem 1, we consider the decomposition (30), where

$$\begin{aligned} y_j(\zeta) &= \varphi_j(\zeta) - \nu_j v_j(\zeta)|\varphi_j(\zeta)| \quad \text{and} \\ v_j(\zeta) &= \sqrt{1 + \varepsilon_j^{-1}\tau_j\Phi_j(\zeta)^2} \end{aligned}$$

for any j . The multipliers ν_j are defined as follows

$$\nu_j \triangleq \begin{cases} \bar{\nu}_j, & j \neq j_0 \\ \nu_{j_0}^{(i)}, & j = j_0. \end{cases}$$

Here $i \in \{0, 1\}$, $\bar{\nu}_j$ is defined in (32) and $\nu_{j_0}^{(i)}$ is from (48). Assume, on the contrary, that for some $T > 0$ one has $|\sigma_{j_0}(T) - \sigma_{j_0}(0)| = k\Delta_{j_0}$, that is, for some $i \in \{0, 1\}$ one has $(-1)^i(\sigma_{j_0}(T) - \sigma_{j_0}(0)) = \Delta_{j_0}$ and decompose the functional (24) in accordance with (30). The conditions (32) and (48) imply (34) for some $\vartheta > 0$. Since $\xi_{j_0}(t) \neq 0$ on $[0, T]$, the second integral in (30) is strictly positive. Therefore

$$\sum_{j=1}^l \varkappa_j \int_0^T \dot{\sigma}_j(t)y_j(\sigma_j(t))dt < \mathfrak{q}.$$

Recall that for $j \neq j_0$ the number $\nu_j = \bar{\nu}_j$ satisfies (29), and (38) holds. The straightforward computation shows that the definition of $\nu_{j_0}^{(i)}$ in (48) implies (47). Retracing the proof of Lemma 4, one has

$$\begin{aligned} 0 < \mathfrak{q} - \sum_j \varkappa_j \int_0^T \dot{\sigma}_j(t)y_j(\sigma_j(t))dt \\ &= \mathfrak{q} - \sum_j \varkappa_j \int_{\sigma_j(0)}^{\sigma_j(T)} y_j(\zeta)d\zeta \\ &= \mathfrak{q} - \sum_{j \neq j_0} \varkappa_j \int_{\sigma_j(0)}^{\sigma_j(T)} y_j(\zeta)d\zeta \\ &\quad - \varkappa_{j_0} \int_{\sigma_{j_0}(0)}^{\sigma_{j_0}(T)} y_{j_0}(\zeta)d\zeta \\ &\stackrel{(26),(38)}{\leq} \mathfrak{q} + \sum_{j \neq j_0} |\varkappa_j|s_j - \underbrace{\varkappa_{j_0} \int_{\sigma_{j_0}(0)}^{\sigma_{j_0}(T)} y_{j_0}(\zeta)d\zeta}_{=(-1)^i \varkappa_{j_0} k \int_0^{\Delta_{j_0}} y_{j_0}(\zeta)d\zeta} \\ &= 0, \end{aligned} \tag{49}$$

arriving thus at a contradiction. Hence the j_0 th component slips less than k cycles. ■

An extension of Theorem 2, allowing to estimate the number of cycles slipped by the component $\sigma_{j_0}(\cdot)$, can be derived in the same way. For $j \neq j_0$, one has to consider the decomposition (36). For $j = j_0$, however, the coefficients $\nu_{j_0 0}^{(i)}$ and $\nu_{j_0 1}^{(i)}$ (where $i \in \{0, 1\}$) have to be chosen in a way to provide (47), namely,

$$\begin{aligned} \nu_{j_0 0}^{(i)} &\triangleq \frac{\int_0^{\Delta_{j_0}} \varphi_{j_0}(\zeta)d\zeta - \frac{(-1)^i}{k\varkappa_{j_0}} \left(\mathfrak{q} + \sum_{j \neq j_0} |\varkappa_j|s_j \right)}{\int_0^{\Delta_{j_0}} |\varphi_{j_0}(\zeta)|\Phi_{j_0}(\zeta)d\zeta}, \\ \nu_{j_0 1}^{(i)} &\triangleq \frac{\int_0^{\Delta_{j_0}} \varphi_{j_0}(\zeta)d\zeta - \frac{(-1)^i}{k\varkappa_{j_0}} \left(\mathfrak{q} + \sum_{j \neq j_0} |\varkappa_j|s_j \right)}{\int_0^{\Delta_{j_0}} |\varphi_{j_0}(\zeta)|d\zeta}. \end{aligned} \tag{50}$$

Using this modified Bakaev–Guzh procedure, the following counterpart of Theorem 2 can be proved.

Theorem 4. Let the assumptions of Theorem 2 be valid. Suppose also that for some $j_0 \in \{1, 2, \dots, l\}$ and integer $k > 0$ the inequalities hold as follows

$$\varkappa_{j_0} \neq 0, \begin{pmatrix} \varepsilon_{j_0} & \frac{\varkappa_{j_0} a_{j_0} \nu_{j_0 1}^{(i)}}{2} & 0 \\ \frac{\varkappa_{j_0} a_{j_0} \nu_{j_0 1}^{(i)}}{2} & \delta_{j_0} & \frac{\varkappa_{j_0} (1 - a_{j_0}) \nu_{j_0 0}^{(i)}}{2} \\ 0 & \frac{\varkappa_{j_0} (1 - a_{j_0}) \nu_{j_0 0}^{(i)}}{2} & \tau_{j_0} \end{pmatrix} > 0 \quad \forall i = 0, 1. \quad (51)$$

Then the component $\sigma_{j_0}(\cdot)$ slips less than k cycles.

In the scalar case, the estimates for the number of slipped cycles are further simplified by noticing that the term $\sum_{j \neq j_0} |\varkappa_j| s_j$ in the formulas for $\nu_{j_0}^{(i)}, \nu_{j_0 0}^{(i)}, \nu_{j_0 1}^{(i)}$ disappears. Denoting for brevity $\Phi(\sigma) = \Phi_1(\sigma_1)$, the following corollaries are obtained.

Corollary 4.1. Assume that $l = 1$ and the frequency-domain condition (23) holds for some $\varkappa \neq 0, \delta, \varepsilon, \tau > 0$ and all $\omega \in \mathbb{R}$. Suppose also that for some integer $k > 0$ the inequality holds as follows

$$2\sqrt{\varepsilon\delta} > |\varkappa \nu^{(i)}|, \quad \nu^{(i)} \triangleq \frac{\int_0^\Delta \varphi(\zeta) d\zeta - \frac{(-1)^i \mathbf{q}}{k\varkappa}}{\int_0^\Delta |\varphi(\zeta)| \sqrt{1 + \varepsilon^{-1} \tau \Phi(\zeta)^2} d\zeta} \quad \forall i \in \{0, 1\}. \quad (52)$$

Then any solution converges to an equilibrium, slipping strictly less than k cycles.

Corollary 4.2. Assume that $l = 1$ and the frequency-domain condition (23) holds for some $\varkappa \neq 0, \delta, \varepsilon, \tau > 0$ and all $\omega \in \mathbb{R}$. Suppose also that for some integer $k > 0, a \in [0, 1]$ and $i \in \{0, 1\}$ the inequality holds

$$\begin{pmatrix} \varepsilon & \frac{\varkappa a \nu_1^{(i)}}{2} & 0 \\ \frac{\varkappa a \nu_1^{(i)}}{2} & \delta & \frac{\varkappa (1 - a) \nu_0^{(i)}}{2} \\ 0 & \frac{\varkappa (1 - a) \nu_0^{(i)}}{2} & \tau \end{pmatrix} > 0, \quad \nu_0^{(i)} \triangleq \frac{\int_0^\Delta \varphi(\zeta) d\zeta - \frac{(-1)^i \mathbf{q}}{k\varkappa}}{\int_0^\Delta |\varphi(\zeta)| \Phi(\zeta) d\zeta}, \quad \nu_1^{(i)} \triangleq \frac{\int_0^\Delta \varphi(\zeta) d\zeta - \frac{(-1)^i \mathbf{q}}{k\varkappa}}{\int_0^\Delta |\varphi(\zeta)| d\zeta}. \quad (53)$$

Then any solution converges to an equilibrium, slipping strictly less than k cycles.

Remark 4.1. The estimates from Corollaries 4.1 and 4.2 can be further improved for the special initial conditions by noticing that the “global” constant \mathbf{q} can be removed by a number q , depending on a specific solution $\sigma(t)$, and featured by the

following property: if $T > 0$ and $|\sigma(0) - \sigma(T)| = k\Delta$, then

$$I_T[\dot{\sigma}(\cdot), \xi(\cdot), \dot{\xi}(\cdot)] \leq q.$$

For instance, if $\xi(0) = \varphi(\sigma(0)) = 0$, then $\xi(T) = \varphi(\sigma(T)) = \varphi(\sigma(0) \pm k\Delta) = 0$. As implied by

Remarks A.1 and A.2 of the Appendix, in this case a much less conservative estimate for q can be obtained.

Example 4.1. We again consider the PLL with a proportional integral low-pass filter, a sine-shaped characteristic of phase frequency detector and a time delay in the loop that has been investigated in Example 3.3. Its mathematical description is borrowed from [Belustina, 1992]:

$$\begin{aligned} \ddot{\sigma}(t) + \frac{1}{T}\dot{\sigma}(t) + \varphi(\sigma(t-h)) \\ + sT\dot{\varphi}(\sigma(t-h)) &= 0, \\ \varphi(\sigma) = \sin \sigma - \beta, \quad s \in (0, 1), \quad \beta \in (0, 1], \\ h > 0, \quad T > 0. \end{aligned} \tag{54}$$

The differential equation (54) can be reduced to integro-differential equation (1) with

$$\begin{aligned} \Gamma(t) &= \begin{cases} 0, & t < h, \\ (1-s)e^{-\frac{t-h}{T}}, & t \geq h, \end{cases} \\ b(t) &= e^{-\frac{t}{T}}(u - (1-s)J), \\ u &\triangleq \dot{\sigma}(0) + sT\varphi(\sigma(-h)), \\ J &\triangleq \begin{cases} \int_{-h}^{t-h} e^{\frac{\lambda+h}{T}} \varphi(\sigma(\lambda))d\lambda, & t \leq h, \\ \int_{-h}^0 e^{\frac{\lambda+h}{T}} \varphi(\sigma(\lambda))d\lambda, & t > h. \end{cases} \end{aligned}$$

Let $\alpha_{21} = -\alpha_{11} = 1$, $\varkappa = 1$, $a_1 = 1$. The frequency-domain condition (23) reduces to

$$\begin{aligned} \Pi(\omega) &\equiv \tau T^2 \omega^4 + \omega^2(T^3 s \cos \omega h \\ &\quad - T^4 s^2(\varepsilon + \tau) + \tau - \delta T^2) \\ &\quad - T^2(1-s)\omega \sin \omega h + T \cos \omega h \\ &\quad - (\varepsilon + \tau)T^2 - \delta \geq 0 \quad \forall \omega; \end{aligned} \tag{55}$$

whereas the inequalities (53) may be rewritten as

$$2\sqrt{\varepsilon\delta} > \frac{2\pi\beta + qk^{-1}}{4(\beta \arcsin \beta + \sqrt{1-\beta^2})}. \tag{56}$$

Notice that for all $\omega \in \mathbb{R}$ one has

$$\begin{aligned} \Pi(\omega) &\geq \Omega_0(\omega) \\ &\equiv \left(\tau T^2 - \frac{1}{2}T^3 s h^2 \right) \omega^4 \\ &\quad + \left(T^3 s - T^4 s^2(\varepsilon + \tau) + \tau - \delta T^2 \right. \\ &\quad \left. - \frac{1}{2}T h^2 - (1-s)T^2 h \right) \omega^2 \\ &\quad + (T - (\varepsilon + \tau)T^2 - \delta) \quad \forall \omega \in \mathbb{R} \end{aligned}$$

and $\Pi(\omega) \approx \Omega_0(\omega)$ when $\omega h \ll 1$.

We consider the case $T \leq 0.9$, $h_0 = \frac{h}{T} \leq 1$, since for small T and small h the PLL is gradient-like for all $\beta \in (0, 1]$ [Belustina, 1992]. Let us choose $\varepsilon = \frac{\beta_0}{T}$, $\delta = \alpha_0 T$, $\tau = \gamma_0 T^3$. As $\Pi(0) = \Omega_0(0)$ it is necessary that $\alpha_0 + \beta_0 + \gamma_0 T^4 \leq 1$. Then the optimal values for α_0 and β_0 are $\alpha_0 = \beta_0 = \frac{1}{2}(1 - \gamma_0 T^4)$, whence $2\sqrt{\varepsilon\delta} = 1 - \gamma_0 T^4$. For $\gamma_0 = \max\{\frac{1}{2}sh_0^2, \frac{1}{2}(h_0 + 1 - s)^2\}$ the polynomial $\Pi_0(\omega)$ is non-negative, $\forall \omega$.

We choose the initial conditions in such a way that $u = K(0)\beta$ [Ershova & Leonov, 1983] and $\varphi(\sigma(0)) = \sin \sigma(0) - \beta = 0$ and apply Corollary 4.2, where q is replaced, in accordance with Remark 4.1, by the better estimate q from Remark A.2, given by

$$\begin{aligned} q &= A + Bh_0 + Ch_0^2, \\ A &\triangleq T^2 \left(\frac{7}{2}\beta^2 + 3 \right), \\ B &\triangleq 3T^2(1-s)(1+\beta)(3\beta+1), \\ C &\triangleq \frac{3}{2}T^2(1-s)^2(1+\beta)^2. \end{aligned} \tag{57}$$

It follows from (56) that the number k_0 of cycles slipped satisfies the inequality

$$\begin{aligned} k_0 \leq r_0 := \lfloor q(8\sqrt{\varepsilon\delta}(\beta \arcsin \beta \\ + \sqrt{1-\beta^2}) - 2\pi\beta)^{-1} \rfloor, \end{aligned} \tag{58}$$

where $\lfloor x \rfloor$ stands for the integer floor of x ; in view of (57), r_0 is increasing in each variable T, β, h_0 .

Choosing $h_0 = h/T = 1$, $s = 0.4$, and $T = 0.1$, Fig. 7 illustrates the curves in the parameter space, corresponding to r_0 from 1 to 4; below each curve the number of slipped cycles does not exceed r_0 (58).

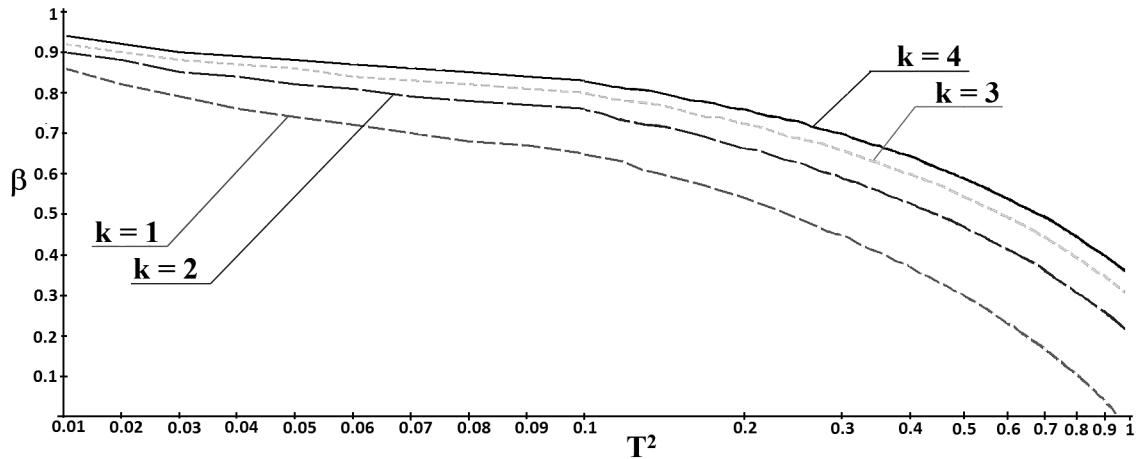

Fig. 7. The estimates of cycle slipping for the system (54) with $s = 0.4$, $h = T$.

5. Frequencies of Periodic Solutions

A natural question that arises is which type of nonconvergent solutions the system (1) may have when the sufficient conditions from Theorems 1 and 2 are violated. In general, if the equilibria’s basins of attraction do not cover the phase space of the system, it may have some “hidden” oscillations and attractors [Leonov & Kuznetsov, 2013; Dudkowski *et al.*, 2016; Jafari *et al.*, 2015]. Whereas the behavior of general nonconvergent solutions of (1) remains a nontrivial open problem, in this section we establish some properties of periodic solutions, where the periodicity is understood in the following generalized sense.

Definition 5.1. Throughout this section, we call the solution $\sigma(t)$ *output-periodic* with period $T_0 > 0$ or, equivalently, frequency $\omega_0 = 2\pi/T_0$, if $\xi(t + T_0) = \xi(t) \forall t \geq 0$. Equivalently, for some integer I_j one has

$$\sigma_j(t + T_0) = \sigma_j(t) + I_j \Delta_j \quad \forall j = 1, \dots, l, \quad \forall t \geq 0. \tag{59}$$

The term “output-periodic” is motivated by the applications to PLLs and other synchronization circuits, where the function $\xi(t) = \varphi(\sigma(t))$ stands for the output of the phase detector (comparator), which does not allow to distinguish “genuine” periodic solutions $\sigma(t) = \sigma(t + T_0)$ from output-periodic ones.

It appears that a “relaxed” version of the frequency-domain inequality (23) allows to prove the absence of output-periodic solutions of certain frequencies. Our approach allows to extend

the results from [Leonov & Speranskaya, 1985] and [Leonov *et al.*, 1996b] and combines the methods of Fourier expansions and Popov’s integral indices. We now formulate a counterpart of Lemma 1 for output-periodic solutions.

Lemma 5. Assume that (23) with some matrices $\varkappa, \varepsilon, \tau, \delta, \alpha_1, \alpha_2 \in \mathcal{D}^l$, $\det \alpha_1 \det \alpha_2 \neq 0$ holds for all $\omega = \omega_0 k$, where $\omega_0 > 0$ and k is integer. Then for any output-periodic solution of (1) one has

$$I_{kT_0}[\dot{\sigma}, \xi, \dot{\xi}] \leq 0, \quad T_0 \triangleq \frac{2\pi}{\omega_0} \\ \forall k \in \mathbb{Z} \triangleq \{0, \pm 1, \pm 2, \dots\}. \tag{60}$$

Here I_T stands for the quadratic integral functional (24).

Lemma 5 and its extension, dealing with more general quadratic functionals, is proved in Appendix. The following “relaxed” version of Theorems 1 and 2 ensures the absence of high-frequency periodic solutions.

Theorem 5. Suppose that diagonal matrices $\varkappa \in \mathcal{D}^l$, $\tau \in \overline{\mathcal{D}}_+^l$, $\varepsilon, \delta \in \mathcal{D}_+^l$, $\alpha_1 \in \mathcal{M}_1$, $\alpha_2 \in \mathcal{M}_2$ exist such that either the algebraic inequalities (32) hold or the inequalities (37) are valid for some $a_j \in [0, 1]$. Then

- (1) if the frequency-domain condition (23) holds for any $\omega = \omega_0 k$, where $\omega_0 > 0$ and $k \in \mathbb{Z}$, then the system (1) has no nonconstant output-periodic solution of the frequency ω_0 ;
- (2) if the frequency-domain condition (23) holds for any $\omega = 0$ and $|\omega| \geq \bar{\omega} > 0$, then all nonconstant output-periodic solutions (if they exist) have frequencies less than $\bar{\omega}$.

Proof. The first statement is proved similarly to Theorems 1 and 2 with the only difference that the inequality (25), ensured by Lemma 1, has to be replaced by (60). Consider that an output-periodic solution of the period $T_0 = 2\pi/\omega_0$ exists. Applying the Bakaev–Guzh procedure (28) in the same way as in the proofs of these theorems, the equality (30) with $T = T_0k$ and (60) imply the following

$$\begin{aligned}
 0 &\stackrel{(60)}{\geq} I_{T_0k}[w(\cdot)] \\
 &= \sum_j \varkappa_j \int_0^{T_0k} \dot{\sigma}_j(t) y_j(\sigma_j(t)) dt \\
 &\quad + \int_0^{T_0k} \sum_j [\varkappa_j \nu_j \dot{\sigma}_j(t) v_j(\sigma_j(t)) |\xi_j(t)| \\
 &\quad + \delta_j |\xi_j(t)|^2 + \varepsilon_j (1 + \varepsilon_j^{-1} \tau_j \Phi_j(\sigma_j(t)))^2 \\
 &\quad \times |\dot{\sigma}_j(t)|^2] dt. \tag{61}
 \end{aligned}$$

The first term in (61) is uniformly bounded over $k = 1, 2, \dots$ due to Proposition 1 and (38). Choosing v_j, ν_j in accordance with (33) or (36), the corresponding set of inequalities (32) or (37) implies that the second integrand in (61) is a positive definite quadratic form and (34) holds for some $\vartheta > 0$. Passing to the limit $k \rightarrow \infty$, $|\xi(\cdot)| \in L_2[0, \infty)$, which is possible only when $\xi(t) \equiv 0$, i.e. the solution $\sigma(t) \equiv \sigma^0$ is constant.

Statement 2 is now obvious: if a nonconstant solution of frequency $\omega_0 < \bar{\omega}$ existed, (23) would be violated for at least one $\omega_0 k, k \in \mathbb{Z}$. The latter is, however, impossible since $|\omega_0 k| \in \{0\} \cup [\bar{\omega}, \infty)$. ■

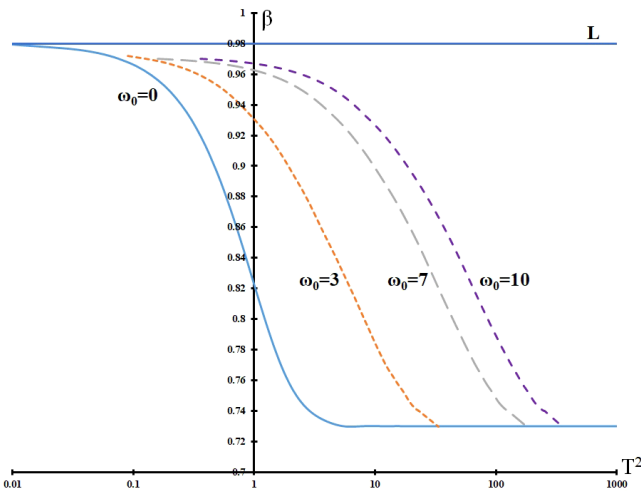

Fig. 8. Domains of stability and slow oscillations for the system (41) with $m = 0.4$.

Example 5.1. Consider again the PLL with sine-shaped characteristic and proportional-integrating filter (41). In Fig. 8, we compare the stability domain for $m = 0.4$ with the domains, where periodic solutions of the frequency $\omega \geq \omega_0$ are absent. The leftmost curve corresponds to phase locking (conditions of Theorem 2 hold), in particular, the absence of periodic trajectories ($\omega_0 \geq 0$). Between this curve and dashed curves, convergence is not guaranteed. At the same time, Theorem 5 guarantees the absence of high-frequency periodic solutions with $\omega \geq \omega_0$, where ω_0 is, respectively, 3, 7 and 10. As $\omega_0 \rightarrow \infty$, such curves converge to the line L , on which the conditions of Theorem 5 fail to hold.

6. Conclusions, Discussion and Related Works

In this paper, the three problems have been addressed that are concerned with the dynamics of infinite-dimensional systems with periodic scalar or vector nonlinearities. We offer the conditions for the solutions’ convergence (referred also to as “phase locking” and gradient-like behavior). These conditions consist of the *frequency-domain* condition (23) providing the *integral quadratic constraint* (IQC) (A.8), and additional algebraic conditions, allowing to derive L_2 -convergence of the solutions from this constraint. Stronger versions of the latter algebraic conditions also give estimates for the number of cycles, slipped by each component of the solution. Relaxing the frequency-domain inequality, the convergence criterion boils down to a condition, ensuring the absence of high-frequency periodic solutions. In this section, we compare the results with previously established criteria and discuss further extensions of the results.

6.1. Comparison with the previous results

The investigation of asymptotic properties of integro-differential Volterra equations proceeds with the similar study of many-dimensional Lur’e-type systems with a “critical” linear part [Gel’fand *et al.*, 2004]:

$$\dot{z}(t) = Az + B\varphi(\sigma), \quad \dot{\sigma}(t) = C^*z + R\varphi(\sigma). \tag{62}$$

Here $z \in \mathbb{R}^m, \sigma \in \mathbb{R}^l; A \in \mathbb{R}^{m \times m}; C, B \in \mathbb{R}^{m \times l}; R \in \mathbb{R}^{l \times l}; A$ is a Hurwitz matrix and the properties

of φ are described in Assumption 2. The transfer function from φ to $-\dot{\sigma}$ is as follows

$$K(p) = -R + C^*(A - pE)^{-1}B. \quad (63)$$

For system (62), counterparts of Theorems 1–5 can be obtained by using special Lyapunov functions. Whereas traditional quadratic Lyapunov functions prove to be inefficient [Gelig *et al.*, 2004; Leonov *et al.*, 1996a] in the analysis of systems with multiple equilibria, the idea of the Bakaev–Guzh decomposition (28) has inspired the nonquadratic Lyapunov-type function as follows

$$\begin{aligned} V(t) &= V(x(t), x(0)) \\ &= x^*(t)Hx(t) + \sum_{j=1}^l \left(\int_{\sigma_j(0)}^{\sigma_j(t)} \varkappa_j y_j(\zeta) d\zeta \right), \end{aligned} \quad (64)$$

where $x = (z, \varphi(\sigma))^T$, $x_t(\cdot)$ stands for the truncation $x|_{[0,t]} : [0, t] \rightarrow \mathbb{R}^{m+l}$, \varkappa_j are parameters and $H = H^* \geq 0$ is a specially chosen matrix. Note that V is not a classical Lyapunov function and depends not only on $x(t)$, but also on $x(0)$ (alternatively, it can be considered as a functional on the system’s trajectory). The matrix H is chosen in a way to provide the condition

$$\dot{V}(t) \leq - \sum_{j=1}^l W_j(|\varphi_j|, v_j \dot{\sigma}_j), \quad (65)$$

where W_j are positive definite quadratic forms. The existence of such a matrix H is guaranteed by an appropriate frequency-domain condition thanks to the seminal Kalman–Yakubovich–Popov (KYP) lemma [Gelig *et al.*, 2004], whereas positivity of W_j requires additional algebraic constraints on the parameters, similar to those arising in Theorem 1. Using (65), it is shown that the system is L_2 -convergent and hence gradient-like [Gelig *et al.*, 2004]; estimates for the number of slipped cycles can be also obtained [Ershova & Leonov, 1983]. The latter results can be further extended [Perkin *et al.*, 2011], replacing in (64), y_j by the convex combination $a_j y_{0j} + (1 - a_j) y_{1j}$ as in (36); W_j in the right-hand side of (65) is replaced by a quadratic form $Q_j(|\varphi_j|, v_{1j} \dot{\sigma}_j, v_{0j} \dot{\sigma}_j)$. The presence of extra parameters a_j adds more flexibility to the frequency-domain condition and algebraic constraints (ensuring positivity of the forms Q_j), leading thus to more exact estimates of the stability domain. The inequality (65) may be directly transformed to a

linear matrix inequality (LMI) [Duan *et al.*, 2007; Yang *et al.*, 2005; Yang & Huang, 2007; Lu *et al.*, 2008]. Unlike the frequency-domain condition, LMI feasibility is not easy to test analytically, but can be tested numerically by using semidefinite programming software.

An alternative method has been proposed in [Leonov *et al.*, 1992; Leonov *et al.*, 1996b], based on the Popov approach. This method directly proves boundedness of integral functionals (“*a priori* integral indices” [Rasvan, 2006])

$$I_T[\sigma(\cdot)] = \int_0^T \sum_{j=1}^l (W_j(|\varphi_j|, v_j \dot{\sigma}_j) + \varkappa_j y_j(\sigma_j) \dot{\sigma}_j) dt \quad (T > 0), \quad (66)$$

under appropriate frequency-domain condition, using a counterpart of Lemma 1. The method of Popov’s integral functionals (66) not only allows to cope with general Volterra equations (1), but also enables the use of Fourier expansion to estimate the frequencies of periodic solutions, as done in the proof of Theorem 5.

In this paper, we extend the aforementioned results by taking into account the *slope restriction* on the nonlinearity. As discussed in Example 3.2, even for a simple second-order system (62), introducing the slope restriction (which corresponds to the choice $\tau > 0$) substantially reduces the conservatism in convergence criteria. Also, the matrices α_1 and α_2 in our criteria are varying parameters. Counter-intuitively, for the pendulum system (Example 3.1 in Sec. 3.2) Theorem 2 gives the best estimate of the convergence domain for $\alpha_{11} = -\infty$ rather than for $\alpha_{11} = \mu_{11}$. All our results deal with the general Volterra integro-differential equation (1), comprising e.g. models of delayed and other infinite-dimensional PLLs.

6.2. Robustness of pendulum-like systems

In this section, we mention briefly two directions for the future research. The first of them addresses pendulum-like systems with *disturbances* [Smirnova *et al.*, 2017; Smirnova *et al.*, 2018a, 2018b]:

$$\begin{aligned} \dot{\sigma}(t) &= b(t) + R\xi(t-h) - \int_0^t \Gamma(t-\tau)\xi(\tau)d\tau, \\ \xi(t) &= \varphi(\sigma(t)) + f(t), \quad t \geq 0. \end{aligned} \quad (67)$$

It is demonstrated in [Smirnova *et al.*, 2017] that in the case where $(f(t) - L)$ and $\dot{f}(t)$ are L_2 -summable

for some constant vector L , Theorems 1 and 2 guarantee the gradient-like behavior of (67), i.e. convergence of the solutions is robust against disturbances from this class. The extension of the convergence criteria to bounded disturbances and robustness of the cycle-slipping estimates are subjects of ongoing research.

The second direction deals with *singular* perturbations of (1) [Smirnova & Proskurnikov, 2017]

$$\begin{aligned} \mu \ddot{\sigma}_\mu(t) + \dot{\sigma}_\mu(t) \\ = b(t) + R\xi_\mu(t - \tau) - \int_0^t \Gamma(t - \tau)\xi_\mu(\tau)d\tau, \\ \xi_\mu(t) = \varphi(\sigma_\mu(t)) \end{aligned} \quad (68)$$

with a positive small parameter $\mu > 0$. As shown in [Smirnova & Proskurnikov, 2017], the conditions of Theorems 1 and 2 permit that (68) is gradient-like for all $\mu \in [0, \mu_0)$ for μ_0 being sufficiently small. To obtain a nonconservative estimate for μ_0 remains a nontrivial problem subject to ongoing research. Singular perturbations in PLLs can stand for a “weak” low-pass filter [Hoppensteadt, 1983].

Acknowledgments

The results of Secs. 3 and 5 and the extensions reported in Sec. 6.2 have been obtained at the Institute for Problems in Mechanical Engineering of the Russian Academy of Sciences (IPME RAS) under the sole support of the Russian Science Foundation (RSF) Grant 16-19-00057. Other results are supported by the Russian Foundation for Basic Research (RFBR) under Grant 17-08-00715. The authors are grateful to Prof. A. S. Matveev and Prof. A. L. Fradkov for fruitful discussions and Prof. O. N. Granichin for the invitation to join the project on cluster dynamics in complex systems, whose results are reported in [Proskurnikov & Granichin, 2018]. The authors are also grateful to Dr. N. Utina and R. Titov for their help with numerical simulations, included in Secs. 3–5.

References

Adkins, B. [1960] *The General Theory of Electrical Machines* (Chapman and Hall).
 Altshuller, D., Proskurnikov, A. & Yakubovich, V. [2004] “Frequency-domain criteria for dichotomy and absolute stability for integral equations with quadratic constraints involving delays,” *Dokl. Math.* **70**, 998–1002.

Ascheid, G. & Meyr, H. [1982] “Cycle slips in phase-locked loops: A tutorial survey,” *IEEE Trans. Commun.* **30**, 2228–2241.
 Bakaev, Y. & Guzh, A. [1965] “Optimal reception of frequency modulated signals under Doppler effect conditions (in Russian),” *Radiotekhnika i Elektronika* **10**, 175–196.
 Baker, G. & Blackburn, J. [2005] *The Pendulum: A Physics Case Study* (Oxford University Press).
 Balas, M. [1978] “Active control of flexible systems,” *J. Optim. Th. Appl.* **25**, 415–436.
 Belustina, L. [1992] “Qualitative-numerical analysis for synchronization system with time-delay (in Russian),” *Proc. Int. Seminar “Nonlinear Circuits and Systems”* (Moscow), pp. 50–59.
 Belyustina, L., Bykov, V., Kiveleva, K. & Shalfeev, V. [1970] “On the magnitude of the locking band of a phase-shift automatic frequency control system with a proportionally integrating filter,” *Radiophys. Quant. Electron.* **13**, 437–440.
 Bergmans, J. [1995] “Effect of loop delay on stability of discrete-time PLL,” *IEEE Trans. Circuits Syst.-I* **42**, 229–231.
 Best, R. [2003] *Phase-Locked Loops: Design, Simulation and Applications* (McGraw-Hill).
 Best, R., Kuznetsov, N., Leonov, G., Yuldashev, M. & Yuldashev, R. [2016] “Tutorial on dynamic analysis of the Costas loop,” *Ann. Rev. Contr.* **42**, 27–49.
 Blekhman, I. [2000] *Vibrational Mechanics* (World Scientific, Singapore).
 Buckwalter, J. & York, R. [2002] “Time delay considerations in high-frequency phase-locked loops,” *IEEE Radio Frequency Integrated Circuits Symp.*, pp. 181–184.
 Chicone, C. & Heitzman, M. [2013] “Phase-locked loops, demodulation, and averaging approximation time-scale extensions,” *SIAM J. Appl. Dyn. Syst.* **12**, 674–721.
 Czolczynski, K., Perlikowski, P., Stefanski, A. & Kapitaniak, T. [2012] “Synchronization of slowly rotating pendulums,” *Int. J. Bifurcation and Chaos* **22**, 1250128-1–14.
 Dörfler, F. & Bullo, F. [2014] “Synchronization in complex networks of phase oscillators: A survey,” *Automatica* **50**, 1539–1564.
 Duan, Z., Wang, J. & Huang, L. [2007] “Criteria for dichotomy and gradient-like behavior of a class of nonlinear systems with multiple equilibria,” *Automatica* **43**, 1583–1589.
 Dudkowski, D., Jafari, S., Kapitaniak, T., Kuznetsov, N., Leonov, G. & Prasad, A. [2016] “Hidden attractors in dynamical systems,” *Phys. Rep.* **637**, 1–50.
 Ershova, O. B. & Leonov, G. A. [1983] “Frequency estimates of the number of cycle slippings in the phase control systems,” *Autom. Rem. Contr.* **44**, 600–607.

- Fradkov, A. [2017] “Horizons of cybernetical physics,” *Phil. Trans. Roy. Soc. A* **375**, 20160223.
- Garber, E. [1967] “Frequency criterion for lack of periodic modes (in Russian),” *Autom. Rem. Contr.*, 178–182.
- Gardner, F. [1966] *Phase-lock Techniques* (Wiley, NY).
- Gelig, A., Leonov, G. & Yakubovich, V. [2004] *Stability of Stationary Sets in Control Systems with Discontinuous Nonlinearities* (World Scientific, Singapore).
- Halanay, A., Leonov, G. & Rasvan, V. [1987] “From pendulum equation to an extended analysis of synchronous machines,” *Rend. Sem. Mat. Univers. Politecn. Torino* **45**, 91–106.
- Hélie, T. [2014] “Simulation of fractional-order low-pass filters,” *IEEE/ACM Trans. Audio Speech Lang. Process.* **22**, 1636–1647.
- Hoppensteadt, F. [1983] “An algorithm for approximate solutions to weakly filtered synchronous control systems and nonlinear renewal processes,” *SIAM J. Appl. Math.* **43**, 834–843.
- Hoppensteadt, F. & Izhikevich, E. [2000] “Pattern recognition via synchronization in phase-locked loop neural networks,” *IEEE Trans. Neur. Netw.* **11**, 734–738.
- Hoppensteadt, F. [2003] “Random perturbations of Volterra dynamical systems in neuroscience,” *Sci. Math. Japonicae Online* **8**, 591–596.
- Izhikevich, E. [1999] “Weakly pulse-coupled oscillators, FM interactions, synchronization, and oscillatory associative memory,” *IEEE Trans. Neur. Netw.* **10**, 508–526.
- Jafari, S., Sprott, J. & Nazarimehr, F. [2015] “Recent new examples of hidden attractors,” *Eur. Phys. J. Special Topics* **224**, 1469–1476.
- Kudrewicz, J. & Wasowicz, S. [2007] *Equations of Phase-Locked Loops. Dynamics on Circle, Torus and Cylinder* (World Scientific, Singapore).
- Leonov, G. & Smirnova, V. [1980] “Reduction method for integro-differential equations,” *Siberian Math. J.* **21**, 565–575.
- Leonov, G. A. & Speranskaya, L. S. [1985] “Beat-frequency estimation in multidimensional phase-lock-loop systems,” *Telecomm. Rad. Engin.* **39-4**, 85–87.
- Leonov, G. A., Reitmann, V. & Smirnova, V. B. [1992] *Non-Local Methods for Pendulum-Like Feedback Systems* (Teubner, Stuttgart-Leipzig).
- Leonov, G. A., Burkin, I. & Shepeljavyi, A. I. [1996a] *Frequency Methods in Oscillation Theory* (Springer, Netherlands).
- Leonov, G. A., Ponomarenko, D. & Smirnova, V. B. [1996b] *Frequency-Domain Methods for Nonlinear Analysis. Theory and Applications* (World Scientific, Singapore).
- Leonov, G. [2006] “Phase synchronization. Theory and applications,” *Autom. Rem. Contr.* **67**, 1573–1609.
- Leonov, G. A. & Fyodorov, A. A. [2011] “Frequency oscillations estimates for digital phase-locked loops,” *Dokl. Math.* **84**, 761–764.
- Leonov, G. & Kuznetsov, N. [2013] “Hidden attractors in dynamical systems. From hidden oscillations in Hilbert–Kolmogorov, Aizerman and Kalman problems to hidden chaotic attractor in Chua circuits,” *Int. J. Bifurcation and Chaos* **23**, 1330002-1–69.
- Leonov, G. A. & Kuznetsov, N. V. [2014] *Nonlinear Mathematical Models of Phase-Locked Loops. Stability and Oscillations* (Cambridge Univ. Press, Cambridge).
- Leonov, G., Kuznetsov, N., Yuldashev, M. & Yuldashev, R. [2015a] “Hold-in, pull-in, and lock-in ranges of PLL circuits: Rigorous mathematical definitions and limitations of classical theory,” *IEEE Trans. Circuits Syst.-I* **62**, 2454–2464.
- Leonov, G., Kuznetsov, N., Yuldashev, M. & Yuldashev, R. [2015b] “Nonlinear dynamical model of Costas loop and an approach to the analysis of its stability in the large,” *Sign. Process.* **108**, 124–135.
- Lin, C.-L. [1993] “Robust control of flexible structures using residual mode filters,” *J. Guid. Contr. Dyn.* **16**, 973–977.
- Lindsey, W. [1972] *Synchronization Systems in Communication and Control* (Prentice-Hall, Englewood Cliffs, NJ).
- Lu, P., Yang, Y. & Huang, L. [2008] “Dynamic feedback control for cycle slipping in a phase-controlled system,” *Nonlin. Anal.: Th. Meth. Appl.* **69**, 314–322.
- Lur’e, A. [1957] *On Some Nonlinear Problems in the Theory of Automatic Control* (H.M. Station. Office, London).
- Margaris, W. [2004] *Theory of the Non-Linear Analog Phase Locked Loop* (Springer, NY).
- Megretski, A. & Rantzer, A. [1997] “System analysis via integral quadratic constraints,” *IEEE Trans. Autom. Contr.* **42**, 819–830.
- Monteiro, L., Canto, N., Chaui-Berlinck, J., Orsatti, F. & Piqueira, J. [2003] “Global and partial synchronism in phase-locked loop networks,” *IEEE Trans. Neur. Netw.* **14**, 1572–1575.
- Niezrecki, C. & Cudney, H. H. [1997] “Structural control using analog phase-locked loops,” *J. Vibr. Acoust.* **119**, 104–109.
- Perkin, A., Shepeljavyi, A. & Smirnova, V. [2009] “Frequency-domain criteria for gradient-like behavior of phase control systems with vector nonlinearities,” *Proc. IEEE Control Applications (CCA) & Intelligent Control (ISIC) Conf.* (St. Petersburg, Russia), pp. 142–146.
- Perkin, A., Smirnova, V., Utina, N. & Shepeljavyi, A. [2011] “Application of the method of Lyapunov periodic functions,” *Vestnik St. Petersburg Univ. Math.* **44**, 197–207.

- Perkin, A., Smirnova, V. & Shepeljavyi, A. [2012] “Frequency-algebraic conditions for stability of phase systems with application to phase-locked loops and synchronization systems,” *Cybern. Phys.* **1**, 188–197.
- Perkin, A., Proskurnikov, A., Shepeljavyi, A. & Smirnova, V. [2013] “Sharpened estimates for the number of slipped cycles in control systems with periodic differential nonlinearities,” *Cybern. Phys.* **2**, 222–231.
- Perkin, A., Proskurnikov, A. & Smirnova, V. [2014] “Asymptotic estimates for gradient-like distributed parameter systems with periodic nonlinearities,” *Proc. 2014 IEEE Multi-Conf. Systems and Control (MSC 2014)* (Antibes, France), pp. 1638–1643.
- Perkin, A., Smirnova, V., Shepeljavyi, A. & Utina, N. [2015] “Upper bounds for frequency of periodic regimes in many-dimensional and infinite dimensional phase synchronization systems,” *Cybern. Phys.* **4**, 41–48.
- Pervachev, S. [1962] “Investigation of capture regime for tracking automatic selector (in Russian),” *Radiotekhnika* **17**, 51–55.
- Popov, V. [1973] *Hyperstability of Control Systems* (Springer-Verlag).
- Proskurnikov, A. & Cao, M. [2017] “Synchronization of pulse-coupled oscillators and clocks under minimal connectivity assumptions,” *IEEE Trans. Autom. Contr.* **62**, 5873–5879.
- Proskurnikov, A. & Granichin, O. [2018] “Evolution of clusters in large-scale dynamics networks,” *Cybern. Phys.* **7**, 102–129.
- Rasvan, V. [2006] “Four lectures on stability. Lecture 3. The frequency domain criterion for absolute stability,” *Contr. Eng. Appl. Inform.* **8**, 13–20.
- Razavi, B. [2003] *Phase-Locking in High-Performance Systems: From Devices to Architectures* (John Wiley & Sons).
- Sancho, S., Ramirez, F. & Suarez, A. [2014] “Stochastic analysis of cycle slips in injection-locked oscillators and analog frequency dividers,” *IEEE Trans. Microw. Th. Tech.* **62**, 3318–3332.
- Shakhgil’dyan, V. V. & Lyakhovkin, A. A. [1972] *Phase-Locked Loops (in Russian, Sistemy Fazovoi Avtopodstroiki Chastoty)* (Svyaz’, Moscow).
- Skorokhod, A., Hoppensteadt, F. & Salehi, H. [2000] *Random Perturbation Methods with Applications in Science and Engineering* (Springer-Verlag).
- Smirnova, V., Proskurnikov, A. & Utina, N. [2015] “Cycle slipping in nonlinear circuits under periodic nonlinearities and time delays,” *Proc. IEEE Int. Symp. Circuits and Systems (ISCAS)* (Lisbon, Portugal), pp. 3084–3087.
- Smirnova, V. & Proskurnikov, A. [2016] “Phase locking, oscillations and cycle slipping in synchronization systems,” *Proc. European Control Conf. (ECC)* (Aalborg, Denmark), pp. 873–878.
- Smirnova, V. B. & Proskurnikov, A. V. [2017] “Singular perturbations of Volterra equations with periodic nonlinearities. Stability and oscillatory properties,” *IFAC-Papers Online* **50**, 8454–8459.
- Smirnova, V. B., Proskurnikov, A. & Utina, N. [2017] “Stability of pendulum-like systems with external disturbances,” *Cybern. Phys.* **6**, 222–231.
- Smirnova, V. B., Proskurnikov, A. V., Utina, N. V. & Titov, R. [2018a] “Dichotomy and stability of disturbed systems with periodic nonlinearities,” *Proc. Mediterranean Conf. Control and Automation (MED)*, pp. 903–908.
- Smirnova, V. B., Proskurnikov, A. V., Utina, N. V. & Titov, R. [2018b] “Forced solutions of disturbed pendulum-like Lur’e systems,” *Proc. IEEE Conf. Control Technology and Applications (CCTA)*, pp. 748–753.
- Sperling, L., Merten, F. & Duckstein, H. [1997] “Rotation und vibration in beispilen zur methode der direkten bewegungsteilung,” *Techn. Mech.* **17**, 231–243.
- Stoker, J. [1950] *Nonlinear Vibrations in Mechanical and Electrical Systems* (Interscience, NY).
- Strogatz, S. [2000] “From Kuramoto to Crawford: Exploring the onset of synchronization in populations of coupled oscillators,” *Physica D* **143**, 1–20.
- Tausworthe, R. [1967] “Cycle slipping in phase-locked loops,” *IEEE Trans. Commun. Tech.* **Com-15**, 417–421.
- Tripathy, M., Mondal, D., Biswas, K. & Sen, S. [2015] “Design and performance study of phase-locked loop using fractional-order loop filter,” *Int. J. Circuit Theor. Appl.* **43**, 776–792.
- Viterbi, A. [1963] “Phase-locked loop dynamics in the presence of noise by Fokker–Planck techniques,” *Proc. IEEE* **51**, 1737–1753.
- Wischert, W., Olivier, M. & Gros Lambert, J. [1992] “Frequency instabilities in phase-locked synthesizers induced by time delays,” *Proc. IEEE Frequency Control Symp.*, pp. 201–206.
- Yakubovich, V. [2000] “Necessity in quadratic criterion for absolute stability,” *Int. J. Robust Nonlin. Contr.* **10**, 889–907.
- Yakubovich, V. [2002] “Popov’s method and its subsequent development,” *Eur. J. Contr.* **8**, 200–208.
- Yang, Y., Duan, Z. & Huang, L. [2005] “Nonexistence of periodic solutions in a class of dynamical systems with cylindrical phase space,” *Int. J. Bifurcation and Chaos* **15**, 1423–1431.
- Yang, Y. & Huang, L. [2007] “Cycle slipping in phase synchronization systems,” *Phys. Lett. A* **362**, 183–188.
- Yevtyanov, S. & Snedkova, V. K. [1968] “Investigation of a phase-lock AFC system with high-order filters by an asymptotic method,” *Telecomm. Radio. Engin. Part II — Radio Engin.* **22**, 105.

Yu, Y.-J. & Wang, Z.-H. [2013] “A fractional-order phase-locked loop with time-delay and its Hopf bifurcation,” *Chinese Phys. Lett.* **30**, 110201.

Appendix A

Proof of Lemma 1

To prove Lemma 1, we will establish a more general fact, similar in spirit to frequency-domain dichotomy criteria for uncertain nonlinear systems [Altshuller *et al.*, 2004]. Consider the integral equation

$$z(t) = b(t) + R\xi(t-h) + \int_0^t \Gamma(t-s)\xi(s)ds, \quad t \geq 0, \quad (\text{A.1})$$

where $z(t), \xi(t) \in \mathbb{R}^l$, $|\xi(\cdot)| \in L_2[-h, 0]$, and $b(t), \Gamma(t), R, h$ are the same as in (1). We also consider a Hermitian form $\mathcal{H}(\tilde{z}, \tilde{\xi}, \tilde{\eta})$, where $\tilde{z}, \tilde{\xi}, \tilde{\eta} \in \mathbb{C}^l$ and the frequency-domain condition is as follows

$$\mathcal{H}(-K(i\omega)\tilde{\xi}, \tilde{\xi}, i\omega\tilde{\xi}) \leq 0 \quad \forall \tilde{\xi} \in \mathbb{C}^l. \quad (\text{FC})$$

Recall that $K(p)$ stands for the transfer function of the system (A.1) from ξ to $(-z)$ and is defined in (22).

Theorem A.1. *Suppose that the condition (FC) holds for any $\omega \in \mathbb{R}$. Assume also that $\xi(\cdot)$ is absolutely continuous on $[0, \infty)$ and $|\xi(t)| \leq m$, $|\dot{\xi}(t)| \leq \bar{m}$ for almost all $t \geq 0$. Then*

$$\begin{aligned} \sup_{T \geq 0} I_T[w(\cdot)] < \infty, \quad I_T[w(\cdot)] \triangleq \int_0^T \mathcal{H}(w(t))dt, \\ w(t) \triangleq (z(t)^\top, \xi(t)^\top, \dot{\xi}(t)^\top)^\top \in \mathbb{R}^{3l}. \end{aligned} \quad (\text{A.2})$$

For the supremum in (A.2), an explicit upper estimate can be found that depends only on the bounds $m, \bar{m}, \|\xi(\cdot)\|_{L_2[-h, 0]}$ and the parameters of Eq. (A.1) but not on a specific solution.

It can be easily checked that Lemma 1 is a special case of Theorem A.1, corresponding to the form

$$\begin{aligned} \mathcal{H}(\tilde{z}, \tilde{\xi}, \tilde{\eta}) &= \text{Re } \tilde{z}^* \varkappa \tilde{\xi} + \tilde{\xi}^* \delta \tilde{\xi} + \tilde{z}^* \varepsilon \tilde{z} \\ &+ (\tilde{z} - \alpha_1^{-1} \tilde{\eta})^* \tau (\tilde{z} - \alpha_2^{-1} \tilde{\eta}) \end{aligned} \quad (\text{A.3})$$

and $z(t) = \dot{\sigma}(t)$, $\xi(t) = \varphi(\sigma(t))$. Assumptions 1 and 2 imply, obviously, that for any solution

of (1) the functions $\xi(t)$ and $\dot{\sigma}(t)$ are bounded, and the explicit estimates for them can be found. Hence, it suffices to prove the general result from Theorem A.1.

Henceforth, following [Yakubovich, 2000, 2002], the vector-functions $w(t)$ from (A.2), where $\xi(\cdot)$ is defined on $[-h, \infty)$ and absolutely continuous on $[0, \infty)$ and $z(t)$ obeys (A.1), are referred to as *processes* of the system (A.1). We introduce the special case of system (A.1), corresponding to $b(t) \equiv 0$

$$z(t) = R\xi(t-h) + \int_0^t \Gamma(t-s)\xi(s), \quad t \geq 0 \quad (\text{A.4})$$

and introduce the set \mathfrak{L} of its processes, having zero initial conditions $\xi(t)$ for $t \leq 0$ and L_2 -stable:

$$\begin{aligned} \mathfrak{L} \triangleq \{w(\cdot) = [z^\top(\cdot), \xi^\top(\cdot), \dot{\xi}^\top(\cdot)]^\top : \\ |\xi|, |\dot{\xi}| \in L_2[0, \infty), \xi(t) \equiv 0 \\ \forall t \leq 0, (\text{A.4}) \text{ holds}\}. \end{aligned}$$

One may notice that any process from \mathfrak{L} satisfies (A.2) due to the Plancherel theorem; in fact, there exists $\max_{T \geq 0} I_T = \sup_{T \geq 0} I_T$. Indeed, I_T depends on $T \geq 0$ continuously, $I_0 = 0$ and, as $T \rightarrow \infty$, has the limit

$$\begin{aligned} \lim_{T \rightarrow \infty} I_T[w(\cdot)] &= \int_0^\infty \mathcal{H}(w(t))dt \\ &\stackrel{(*)}{=} \frac{1}{2\pi} \int_{-\infty}^\infty \mathcal{H}(\tilde{w}(i\omega))d\omega \\ &\stackrel{(\text{FC})}{\leq} 0 \quad \forall w(\cdot) \in \mathfrak{L}. \end{aligned} \quad (\text{A.5})$$

Here $\tilde{w} = \mathcal{F}w$ stands for the Fourier transform of the vector-function $w(t)$. The equality marked with (*) is implied by the Plancherel theorem. To derive the inequality (A.5), it remains to use the properties of the Fourier transform and the assumptions $\xi(t) \equiv 0 \forall t < 0$ and $b(t) \equiv 0$, entailing that $(\mathcal{F}\xi)(i\omega) = i\omega(\mathcal{F}\xi)(i\omega)$ and $(\mathcal{F}z)(i\omega) = -K(i\omega)(\mathcal{F}\xi)(i\omega)$ due to (A.1). Hence $\mathcal{H}(\tilde{w}(i\omega)) = \mathcal{H}(-K(i\omega)\tilde{\xi}(i\omega), \tilde{\xi}(i\omega), i\omega\tilde{\xi}(i\omega)) \leq 0$.

To establish (A.2) for the general process $w(t)$, which obeys the system (A.1) with $b(t) \neq 0$ with nonzero initial conditions and which need not be L_2 -stable, we fix $T > 0$ and approximate $w(\cdot)$ on $[0, T]$ by the function $w_T(\cdot) \in \mathfrak{L}$, which is constructed as

follows. First, we define for $c > 0$

$$\xi_T(t) = \begin{cases} \xi^+(t), & t < T, \\ \xi^+(T)e^{c(T-t)}, & t \geq T, \end{cases}$$

$$\xi^+(t) \triangleq v(t)\xi(t), \quad v(t) \triangleq \begin{cases} 0, & t < 0, \\ t, & 0 \leq t \leq 1, \\ 1, & t > 1. \end{cases} \tag{A.6}$$

It is obvious that $\xi^+(t)$ is absolutely continuous on \mathbb{R} and $\xi(t) = 0$ when $t \leq 0$. Let $z_T(t)$ be the solution of (A.4), corresponding to $\xi = \xi_T$, and $w_T(\cdot) \in \mathcal{E}$ denote the corresponding process.

Let $z_T^0(t) \triangleq z(t) - z_T(t)$, $\xi_T^0(t) \triangleq \xi(t) - \xi_T(t)$, $w_T^0(t) \triangleq w(t) - w_T(t)$. Obviously,

$$\xi_T^0(t) = (1 - v(t))\xi(t),$$

$$z_T^0(t) = b(t) + R\xi_T^0(t - h) + \int_0^t \Gamma(t - s)\xi_T^0(s)ds$$

$$\forall t \in [0, T].$$

Since $0 \leq v(t) \leq 1$ due to (A.6), there exist constants $c_i, i = 1, \dots, 4$, such that

$$\|w_T^0\|_{L_1[0,T]} \leq c_1, \quad \|w_T^0\|_{L_2[0,T]} \leq c_2,$$

$$\|w_T\|_{L_\infty[0,T]} \leq c_3, \quad \|w_T(\cdot)\|_{L_2[T,\infty]} \leq c_4.$$

The constants c_i are determined by m, \bar{m} , the initial conditions and the parameters of (A.1). Introducing the matrix $H = H^*$ of the Hermitian form \mathcal{H} , we have

$$\begin{aligned} \mathcal{H}(w(t)) &= w(t)^\top H w(t) \\ &= 2w_T(t)^\top H w_T^0(t) + \mathcal{H}(w_T^0(t)) \\ &\quad + \mathcal{H}(w_T(t)). \end{aligned} \tag{A.7}$$

Integrating the latter equality over $[0, T]$, one arrives at the following

$$\begin{aligned} I_T[w(\cdot)] &= 2 \int_0^T w_T(t)^\top H w_T^0(t) dt \\ &\quad + I_T[w_T^0(\cdot)] + I_T[w_T(\cdot)] \\ &\stackrel{(A.5)}{\leq} |H|(c_1 c_3 + c_2^2) - \underbrace{\int_T^\infty \mathcal{H}(w_T(t)) dt}_{\leq |H|c_4^2} \\ &\leq |H|(c_1 c_3 + c_2^2 + c_4^2). \end{aligned} \tag{A.8}$$

Remark A.1. For special solutions and Hermitian forms \mathcal{H} , the estimate (A.8) can be tightened. For instance, in the case where $\xi(0) = 0$ one may replace $\xi^+(t)$ from (A.6) by the simpler function

$$\xi^+(t) = \begin{cases} 0, & t < 0, \\ \xi(t), & t \geq 0. \end{cases}$$

In this case, for $t \in [0, T]$ one has $\xi_T^0(t) = 0$ and $|z_T^0(t)|$, as well as the constants c_1, c_2 , depending only on the initial conditions and $b(\cdot)$. The estimate for $\mathcal{H}(w_T^0) = \mathcal{H}(z_T^0, 0, 0)$ in (A.7) can often be improved, e.g. for the form (A.3) one has $\mathcal{H}(w_T^0(t)) = z_T^0(t)^\top (\tau + \varepsilon) z_T^0(t) \leq (\max_j(\tau_j + \varepsilon_j)) |z_T^0(t)|^2 < |H| |w_T^0(t)|^2$.

Remark A.2. Assume that $\mathcal{H}(z, 0, 0) \geq 0$ for any $z \in \mathbb{C}^l$, which inequality holds e.g. for (A.3). Consider such an instant $T > 0$ that $\xi(T) = 0$, and hence $\xi_T(t) \equiv 0$ for $t \geq T$. Hence, $\mathcal{H}(w_T(t)) \geq 0$ for $t \geq T$ and

$$\begin{aligned} I_T[w_T(\cdot)] &= \int_0^\infty \mathcal{H}(w_T(t)) dt - \int_T^\infty \mathcal{H}(w_T(t)) dt \\ &\stackrel{(A.5)}{\leq} - \int_T^\infty \mathcal{H}(w_T(t)) dt \leq 0. \end{aligned}$$

For such an instant T , the inequality (A.8) can be further improved

$$I_T[w(\cdot)] \leq q = 2 \int_0^T w_T(t)^\top H w_T^0(t) dt + I_T[w_T^0(\cdot)].$$

Combining the tricks from Remarks A.1 and A.2, one can substantially improve the estimate of $I_T[w(\cdot)]$ in the case where $\xi(0) = \xi(T) = 0$; this is useful in the analysis of cycle slipping as in Example 4.1.

Appendix B

Proof of Lemma 5

We again introduce the general linear system (A.4) and a Hermitian form \mathcal{H} . Noting that output-periodic solutions $\sigma(t)$ correspond to periodic processes $w(t)$, Lemma 5 is implied by the following.

Theorem B.1. *Suppose that the inequality (FC) holds for any $\omega = \omega_0 k$, where k is integer and $\omega_0 > 0$. Denote $T_0 \triangleq 2\pi/\omega_0$. Then for any locally L_2 -summable T_0 -periodic process $w(t) = [z^\top(t), \xi^\top(t), \dot{\xi}^\top(t)]^\top$ and any integer $k \geq 1$, the*

inequality holds as follows

$$I_{T_0 k}[w(\cdot)] = \int_0^{T_0 k} \mathcal{H}(w(t)) dt \leq 0. \quad (\text{B.1})$$

Proof. Due to T_0 -periodicity of the solution, one has $I_{kT_0}[w(\cdot)] = kI_{T_0}[w(\cdot)]$, so it suffices to prove (B.1) for $k = 1$. Since $\xi(t), \dot{\xi}$ are T_0 -periodic and locally L_2 -summable, they are decomposable into the series

$$\begin{aligned} \xi(t) &= \sum_{k=-\infty}^{+\infty} \tilde{\xi}_k e^{i\omega_0 k t}, \\ \dot{\xi}(t) &= \sum_{k=-\infty}^{+\infty} (i\omega_0 k) \tilde{\xi}_k e^{i\omega_0 k t}, \\ \sum_{k=-\infty}^{\infty} |\tilde{\xi}_k|^2 &< \infty. \end{aligned} \quad (\text{B.2})$$

Here $\tilde{\xi}_k \in \mathbb{C}^l$ and the convergence of the Fourier series in (B.2) is understood in $L_2[0, T_0]$ -norm (equivalently, the series converge in L_2 -norm on any interval $[t_0, t_0 + T_0]$). Substituting (B.2) into (A.1),

one obtains

$$\begin{aligned} z(t) &= b(t) + \int_t^{+\infty} \Gamma(\tau) \xi(t - \tau) d\tau + R\xi(t - h) \\ &\quad + \int_0^{+\infty} \Gamma(\tau) \xi(t - \tau) d\tau \\ &= \beta(t) - \sum_{k=-\infty}^{+\infty} K(i\omega_0 k) \tilde{\xi}_k e^{i\omega_0 k t}. \end{aligned}$$

Here the series converge in L_2 -norm on any interval $[t_0, t_0 + T_0]$ and $\beta(t) \xrightarrow{t \rightarrow \infty} 0$. Recalling that $z(t)$ is T_0 -periodic, the same holds for $\beta(t)$ and thus $\beta(t) \equiv 0$. Using the Parseval theorem, one has

$$\begin{aligned} I_{T_0}[w(\cdot)] &= \int_0^{T_0} \mathcal{H}(w(t)) dt \\ &= T_0 \sum_{k=-\infty}^{\infty} \mathcal{H}(-K(i\omega_0 k) \tilde{\xi}_k, \tilde{\xi}_k, i\omega_0 k \tilde{\xi}_k) \\ &\leq 0 \end{aligned}$$

since, by assumption, (FC) holds for any $\omega = \omega_0 k$. ■