

Part III - Ch 3 Waterway elements

Verheij, H.J.; van der Hout, A.J.; Koedijk, O.C.; Bakker, F.P.; van Koningsveld, M.; de Vriend, H.J.

Publication date

2021

Document Version

Final published version

Published in

Ports and Waterways

Citation (APA)

Verheij, H. J., van der Hout, A. J., Koedijk, O. C., Bakker, F. P., van Koningsveld, M., & de Vriend, H. J. (2021). Part III - Ch 3 Waterway elements. In M. V. Koningsveld, H. J. Verheij, P. Taneja, & H. J. de Vriend (Eds.), *Ports and Waterways: Navigating a changing world* (pp. 271-299). TU Delft OPEN Publishing.

Important note

To cite this publication, please use the final published version (if applicable).
Please check the document version above.

Copyright

Other than for strictly personal use, it is not permitted to download, forward or distribute the text or part of it, without the consent of the author(s) and/or copyright holder(s), unless the work is under an open content license such as Creative Commons.

Takedown policy

Please contact us and provide details if you believe this document breaches copyrights.
We will remove access to the work immediately and investigate your claim.

3 Waterway elements

¹Waterways generally consist of various elements, such as river reaches, canal sections, locks, weirs and bridge passages. In this chapter we will focus on the design of locks and bridges. An important source of information for this chapter - as far as the Dutch waterways are concerned - are Rijkswaterstaat's Waterway Guidelines 2020 (RVW, 2020, in Dutch; latest English version: 2020). In 2019 PIANC issued its 'Design Guidelines for Inland Waterway Dimensions' (InCOM WG Report 141 PIANC, 2019a), based on the national guidelines of the member states. This does not conflict with the Rijkswaterstaat guidelines. Other relevant manuals are PIANC Report 106 'Innovations in navigation lock design' (PIANC, 2009) and PIANC Report 155 'Ship behaviour in locks and lock approaches' (PIANC, 2014e). In this chapter, we will focus on the situation in the Netherlands, as an illustration of how one can go about the design and operation of these waterway elements.

3.1 Functional design of locks

Sometimes it is necessary to separate bodies of water along a waterway by a structure. This can be the case if

- the water level in a certain part has to be set up for navigability, like in a canalised river;
- the water level at one side has to be set up for storage, like in the case of a reservoir;
- the water level at one side has to remain constant, while at the other side it may vary; this is the case, for instance, where a canal meets a river, but also at a transition between tidal and non-tidal waters, or at a flood defence dam or a storm surge barrier;
- the water is saline at one side and fresh at the other, like in the case of sea locks.

Such a separating structure may be a weir, a dam or a storm surge barrier provided with a lock to enable navigation, but it may also be the lock, itself. A structure can be provided with a single lock, or with a system of locks (Figure 3.1).



Figure 3.1: Multiple-lock systems. Left: Sea Locks (major lock as projected), IJmuiden, Netherlands (<https://beeldbank.rws.nl>, Rijkswaterstaat, by: Harry van Reeken); right: Three Gorges Project, China (Three Gorges Locks by RThiele is licenced under CC BY-SA 3.0).

Apart from the different separation functions mentioned above, locks may also be distinguished by vessel type:

- locks for commercial sea-going vessels, like the locks in the Panama Canal (Part III – Chapter 1), or those in the North Sea Canal at IJmuiden (Figure 3.1, left),
- locks for commercial inland vessels, like the locks in the river Maas (Figure 3.2),

¹This chapter made use of 'Capacities of Inland Waterways' (Groenvelde et al., 2006), lecture notes for the Ports and Waterways course CIE5306 at TU Delft.

- locks for recreational vessels, like the lock between the river IJssel and the Reevediep bypass towards Lake IJssel (Figure 3.3, left),
- locks for mixed commercial and recreational vessels (Figure 3.3, right).



Figure 3.2: Locks at Lith for commercial traffic at the Maas river (*image* by <https://beeldbank.rws.nl>, Rijkswaterstaat, by: Bart van Eyck).



Figure 3.3: Locks for recreational (left) and mixed (right) traffic (*Sluiskolk zeilboot pleziervaart beroepsvaart* and *Sluiskolk beroepsvaart recreatievaart* by <https://beeldbank.rws.nl>, Rijkswaterstaat).

Lock passage is a time-consuming operation which may limit the capacity of a waterway. Therefore, capacity is an important criterion for lock design. In order to determine this capacity, the lock passage process needs to be analysed. We will describe this analysis before going into the functional and dimensional requirements of the various elements.

3.1.1 Lock operation

One perspective of the locking cycle is that of the lock operator, who will focus on the following points successively (RWS, 1973):

1. the stern of the last ship of the previous locking cycle passes the lock sill on exit,
2. the stern of the first ship of the new cycle passes the lock sill while entering the lock chamber,
3. the stern of the last ship of this cycle passes the lock sill, so door closing can begin,
4. the doors are closed and the water level in the lock chamber can be adjusted to that at the exit side,
5. the water level in the chamber is (almost) adjusted and the exit doors can be opened,
6. the exit doors are open and the stern of the first ship leaving passes the lock sill,
7. the stern of the last ship leaving passes the lock sill and the operation in opposite direction can begin when this ship has passed the waiting area.

Figure 3.4 summarizes this in a schematic diagram.

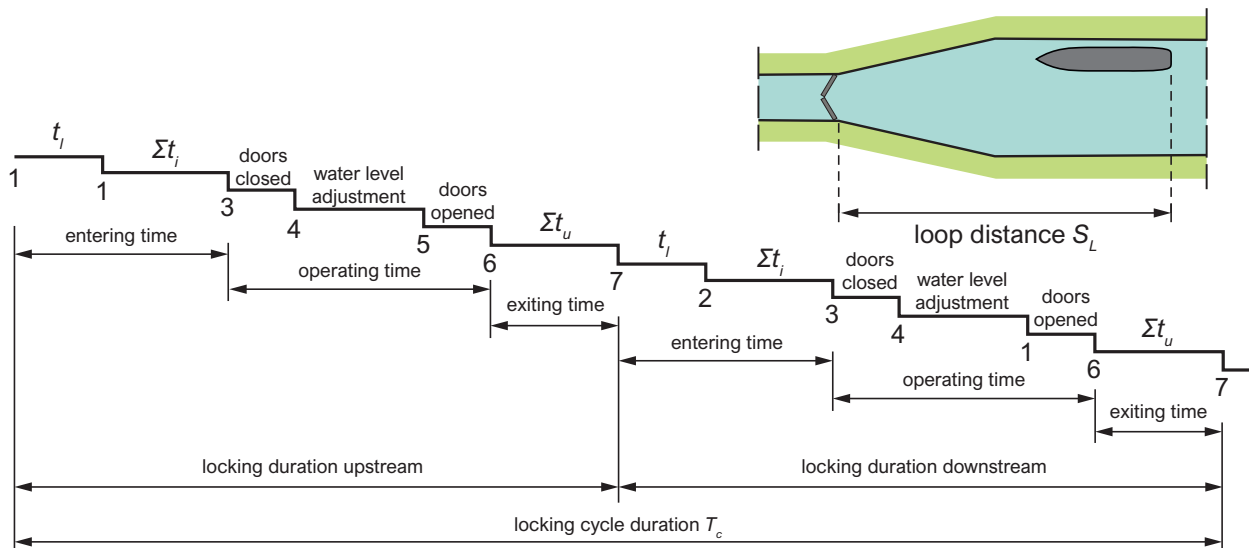

Figure 3.4: Schematic of a locking cycle (by TU Delft – Ports and Waterways is licenced under CC BY-NC-SA 4.0).

The total duration of the locking cycle follows from:

$$\begin{aligned}
 T_c = & \left(t_l + \sum_{i=2}^{nu} t_i + T_{\text{close}} + T_{\text{waterlevel}} + T_{\text{open}} + \sum_{u=1}^{nu} t_u \right)_{\text{up}} + \\
 & \left(t_l + \sum_{i=2}^{nd} t_i + T_{\text{close}} + T_{\text{waterlevel}} + T_{\text{open}} + \sum_{u=1}^{nd} t_u \right)_{\text{down}}
 \end{aligned} \tag{3.1}$$

Where:

- T_c = the total duration of the locking cycle (upstream + downstream)
- nu = number of vessels to be locked through in the upstream phase,
- nd = number of vessels to be locked through in the downstream phase,
- t_l = the so-called loop time, i.e the time between the moment the stern of the last ship leaves the lock and the time the stern of the first ship enters the lock,
- t_i = the entering time of vessel i ,
- t_u = the exiting time of vessel u ,
- T_{close} = the time needed to close the gate or doors,

$T_{\text{waterlevel}}$ = the time needed to adjust the water level in the lock chamber,
 T_{open} = the time needed to open the gate or doors.

Note that the entrance of the first vessel is counted when its stern passes the lock sill, in line with a general agreement to count vessels by the stern. It means that this vessel's approach to the lock and its lock entrance are added to the loop time, in contrast to all following vessels. Consequently, the counter i of the t_i summations in Equation 3.1 starts at $i = 2$.

Figure 3.4 shows a number of other time spans:

entering time:

$$t_l + \sum_{i=2}^n t_i \quad (3.2)$$

operating time:

$$T_{\text{operation}} = T_{\text{close}} + T_{\text{waterlevel}} + T_{\text{open}} \quad (3.3)$$

exiting time:

$$\sum_{u=1}^n t_u \quad (3.4)$$

Note that if the lock operates only in one direction, the formula for the total locking cycle becomes slightly different, because after the vessels have left the lock, the water level in the chamber has to be restored before the next cycle can begin:

$$T_c = t_l + \sum_{i=2}^n t_i + T_{\text{operation}} + \sum_{u=1}^n t_u + T_{\text{operation}} \quad (3.5)$$

The lock capacity is defined as the maximum quantity of traffic that can be locked through per unit time if the lock is continuously in operation. It can be expressed in numbers of vessels, in dead-weight carrying capacity, or otherwise. When expressed in numbers of ships, it is given by

$$C_s = 2n_{\text{max}}/T_c \quad (3.6)$$

in which n_{max} is the average number of vessels per locking operation in a large number of operations with a full chamber. This can be translated to tonnage per unit time via

$$C_T = C_s \bar{T}_{dw} \quad (3.7)$$

in which \bar{T}_{dw} is the average dead-weight carrying capacity per vessel.

Note, however, that this capacity definition refers to full capacity operations in both directions. If traffic is mainly in one direction, one may define the capacity in that direction by

$$C_s = n_{\text{max}}/T_c \quad (3.8)$$

Note that the total cycle duration T_c is still in the denominator of this formula. This means that if the traffic in the other direction becomes less and T_c decreases accordingly, the lock capacity increases, until it reaches its maximum if there is no traffic in the other direction and Equation 3.5 applies to T_c .

From the point of view of a passing vessel's skipper, the lock cycle can be separated into the following phases (see Figure 3.5):

- (0 → 1) approaching the lock at cruising speed
- (1 → 2) arrival at the upstream lock area, slowing down to full stop and mooring in the waiting area,
- (2 → 3) waiting until the lock can be entered,
- (3) once the last ship leaving the lock has passed: unmooring and marshalling for lock entry,
- (3 → 4) speeding up, entering the lock chamber,
- (4 → 5) once in the lock chamber: slowing down and mooring,
- (4 → 5) once the lock chamber is full (or all waiting vessels are in): door closing and water level adjustment in the lock chamber,
- (6) other door opening and unmooring,
- (6 → 7) speeding up and leaving the lock chamber,
- (8) ship stern passes the exit lock sill,
- (9) leaving the other lock area and continuing the journey at cruising speed.

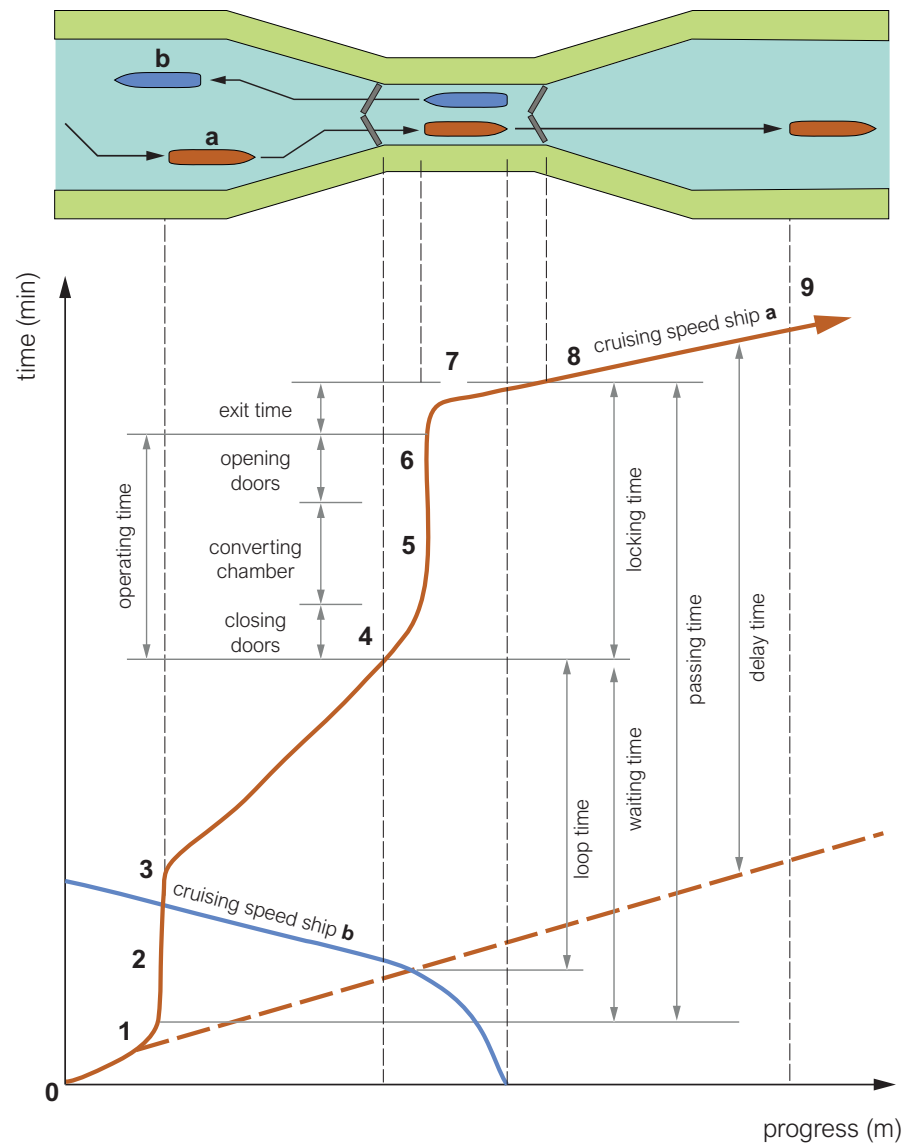

Figure 3.5: Tracking diagram for single vessel (red) passing a lock (by TU Delft – Ports and Waterways is licenced under CC BY-NC-SA 4.0).

The skipper will experience the lock passage as an inhibitory factor of his journey and will be inclined to compare the gross lock passage time with the time he would have needed if the lock would not have been there (and would not have been necessary). Therefore, the net lock delay time of an individual vessel, t_d , is its total lock passage time ($t_w + t_s$) minus its passage time at undisturbed cruising speed:

$$t_d = t_w + t_s - L_{\text{lock}}/V_s \quad (3.9)$$

where:

| | |
|-------------------|---------------------------------------------------|
| t_d | = net lock delay time of an individual vessel, |
| t_w | = waiting time, |
| t_s | = locking time, |
| L_{lock} | = lock length (entry area plus the lock chamber), |
| V_s | = undisturbed vessel cruising speed. |

The total waiting time may range from zero to a number of locking cycles in case of heavy traffic:

$$t_w = kT_c + t_{wr} \quad (k = 0, 1, 2, \dots) \quad (3.10)$$

in which t_{wr} is the remaining waiting time after the last cycle before entering has been completed.

The opening and closing times of the lock gates depend on the type of gate and the width of the lock. [Table 3.1](#) gives examples of observed operating times for three types of electrically operated gates.

| Gate type | Chamber width (m) | Closing time T_{close} (min) | Opening time T_{open} (min) | Total gate operation time (min) |
|--------------------|-------------------|---------------------------------------|--------------------------------------|---------------------------------|
| Rolling gate | 12 | 1.2 | 0.7 | 1.9 |
| Vertical lift gate | 14 – 18 | 3.0 – 3.3 | 2.0 – 2.3 | 5.0 – 5.6 |
| Mitre gate | 16 – 24 | 1.3 – 2.5 | 1.2 – 2.6 | 2.5 – 4.1 |

Table 3.1: Gate operating times (by TU Delft – Ports and Waterways is licenced under CC BY-NC-SA 4.0).

The time needed for water level adjustment depends on the system used for filling and emptying the lock chamber. This will be discussed in [Chapter 4](#). An important aspect is the ship motion during filling and emptying. When filling the chamber, the decelerating entry flow may be quite turbulent. If the chamber is filled or emptied from one end, this may give rise to translation waves and density currents travelling up and down the chamber, reflecting against the gates ([Figure 3.6](#)).

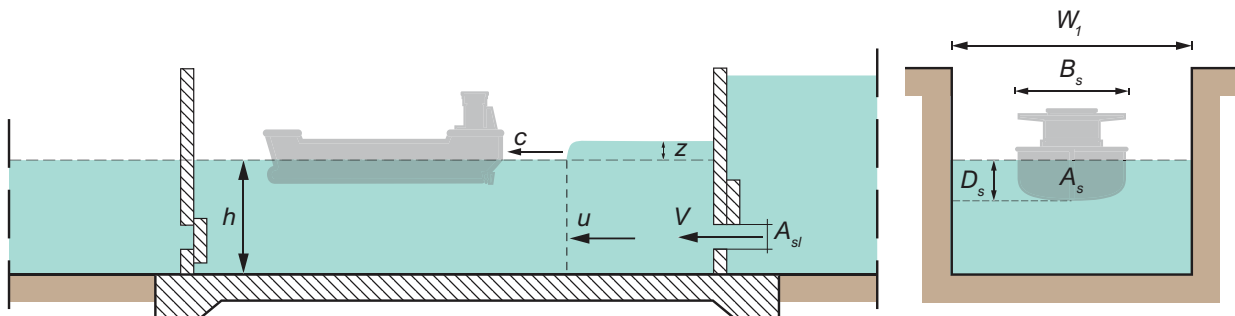

Figure 3.6: Translation wave in a lock chamber (by TU Delft – Ports and Waterways is licenced under CC BY-NC-SA 4.0).

The vessels moored in the chamber will respond to these effects, yielding large time-varying forces in hawsers and bollards (Figure 3.7). In order to avoid excessive hawser forces, only one hawser is tightened, whereas the other one is allowed to slip, so as to absorb the vessel's kinetic energy. In Part IV – Section 4.2 we describe how hawser and bollard forces can be estimated.

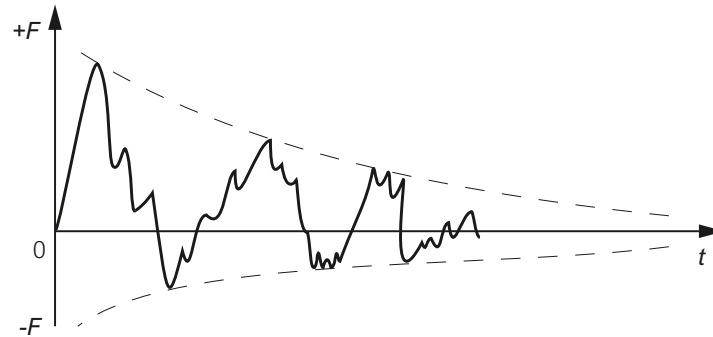

Figure 3.7: Hawser forces exerted by a vessel in a lock chamber (by TU Delft – Ports and Waterways is licenced under CC BY-NC-SA 4.0).

3.1.2 Entry and exit times

The entry (following the first vessel entering) and exit times of vessels are determined on the basis of a large number of field measurements, as a theoretical approach is hardly possible. In a major study in the Netherlands (RWS, 1973) entry and exit times were determined in a large number of locks (16 lock complexes and 23 lock chambers). The data show a considerable scatter, particularly due to the influence of human behaviour and differences in manoeuvrability of the vessels.

Figure 3.8 gives two practical examples. The top panel refers to the entry following times (t_i) of laden motor vessels in the *Hartelshuizen* (chamber dimensions $24 \times 280 \text{ m}^2$ and $12 \times 120 \text{ m}^2$). The bottom panel refers to the exit following times (t_u) of laden motor vessels at the *Volkerakshuizen* (chamber dimensions $24 \times 325 \text{ m}^2$).

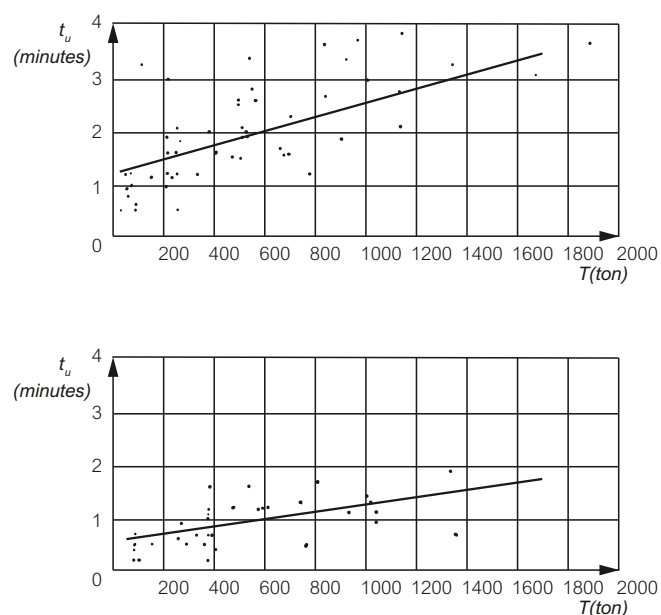

Figure 3.8: Examples of entry and exit times as function of the carrying capacity of a vessel (by TU Delft – Ports and Waterways is licenced under CC BY-NC-SA 4.0).

The data for motor vessels led to the following conclusions:

1. The entry and exit times increase with the vessel's load capacity.
2. The entry and exit times of unloaded vessels are significantly shorter than for loaded ones.
3. The entry and exit times of a ship with a specific load capacity clearly increases as the cross-sectional area of the lock chamber ($A_{lock} = W_l h$) decreases.
4. The entry and exit (following) times for towed barges are clearly longer than for motor vessels or push-barge convoys.
5. The entry and exit times are unfavourably influenced by chamber shapes that deviate from a rectangular profile (e.g. a so-called 'green' chamber) and by 'blindly' situated waiting areas (e.g. in bends).
6. The loop time is directly dependent on the so-called loop distance S_l (see Figure 3.4).

The resistance when entering or leaving a lock is taken into account as a function of the blockage coefficient A_s/A_{lock} .

In the transition between the lock approach and the relatively narrow lock a ship has to adapt to changing hydrodynamics. A sudden transition in width causes the following phenomena:

- an increase of the return current and the water level depression,
- a positive translation wave entering the lock chamber;
- a negative translation wave propagating into the lock approach area.

The higher the vessel's speed and the larger the blockage coefficient, the stronger these phenomena are.

As a result of these phenomena, a vessel's speed during the actual lock entry may be rather irregular (Figure 3.9). In practice, however, it appears that with a blockage coefficient less than 0.4 there is generally little cause for concern.

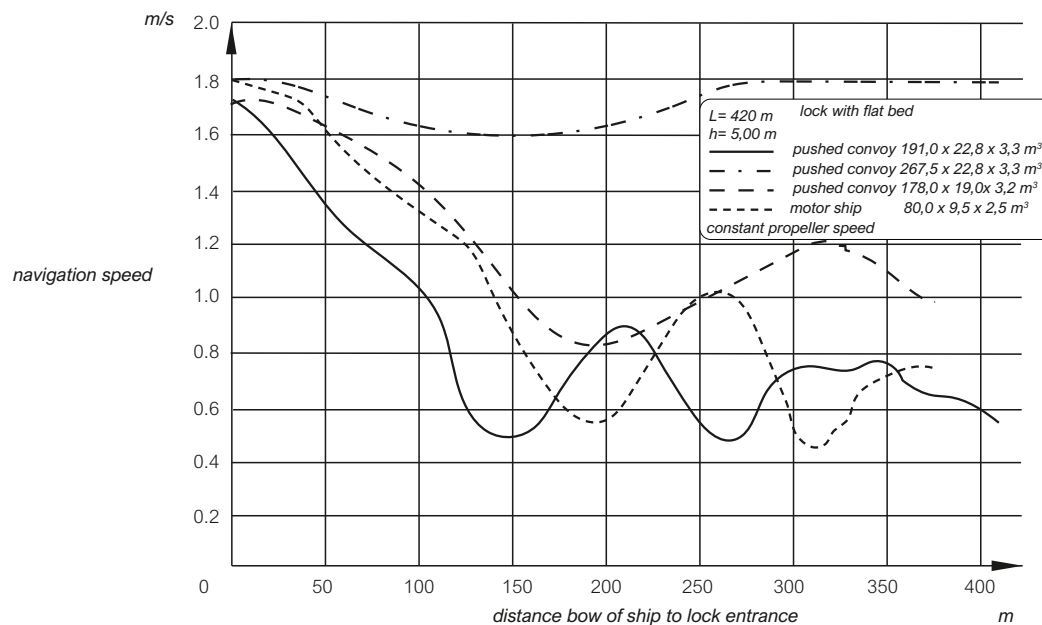

Figure 3.9: Variation of navigation speed when entering a lock (Kooman, 1973) (by TU Delft – Ports and Waterways is licenced under CC BY-NC-SA 4.0).

Another problem applies to loaded push-barge convoys in inland locks and the largest sea-going vessels in maritime locks (blockage coefficient 0.7 to 0.8). Their initial speed (V_s) may not be too large, in order to keep the translation wave created by them from causing damage to the closed gates the first time it rebounds.

Figure 3.10 shows the relationship between the blockage coefficient and the entry and exit times for loaded and unloaded standard ships. The figure was determined for locks with a head width equal to the chamber width and a well-arranged situation. Corrections are needed in case of deviations from these conditions, such as towed barges, different lock shapes, wind hindrance and unfavourably arranged situations. Note that the standards used here are *not* the CEMT- or RWS 2010 standards.

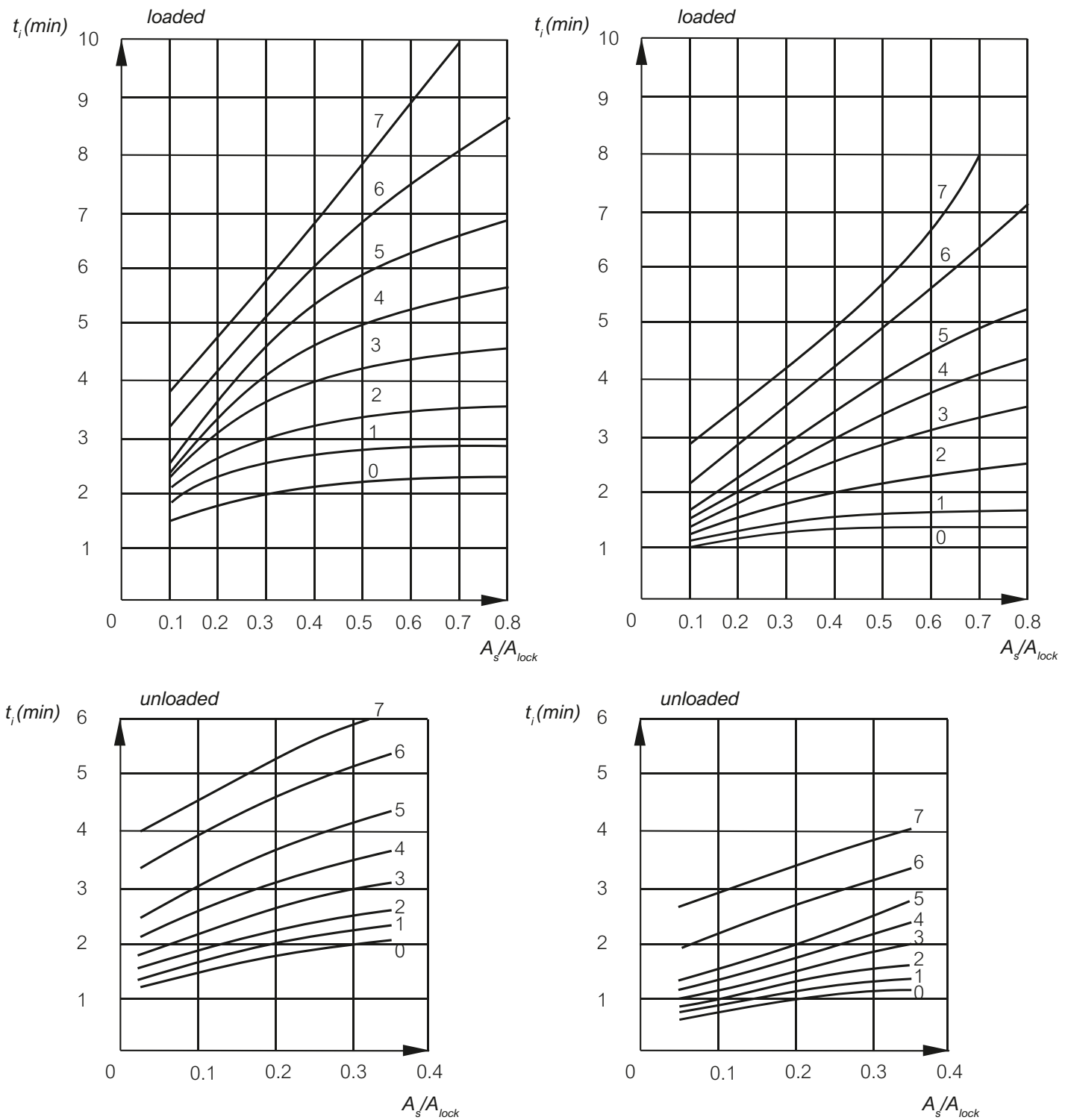

Figure 3.10: Entry and exit times for loaded and unloaded standard vessels (for codes see table) (by TU Delft – Ports and Waterways is licenced under CC BY-NC-SA 4.0).

Although out of date as such (Kooman and De Bruijn, 1975), the values from Figure 3.10 can be used as input to demonstrate how lock dimensions and capacities can be calculated. The Dutch Commissie Vaarweg Beheerders (CVB, Commission of Fairway Managers) strongly recommends that with a large volume of traffic (> 10.000 passages per year) the necessary number of lock chambers and the minimum dimensions thereof should be determined with the aid of simulation models. For the sake of the present explanation, we will stick to the situation in the 1970s.

For a first impression one can use the average values for t_i and t_u for a given traffic mix:

$$\bar{t}_i = \sum_{s=0}^m (P_s \cdot t_{is}) \quad (3.11)$$

and

$$\bar{t}_u = \sum_{s=0}^m (P_s \cdot t_{us}) \quad (3.12)$$

where P_s is the percentage of the vessel class in the traffic mix and m_{cap} is the highest occurring dead-weight capacity class; t_{is} and t_{us} are the entry and exit following time for class s , respectively.

Other input needed is the fleet composition. In 1972-1973 fleet divisions in the Netherlands were established as a function of the average carrying capacity \bar{T}_{dw} of the vessel mix (Figure 3.11).

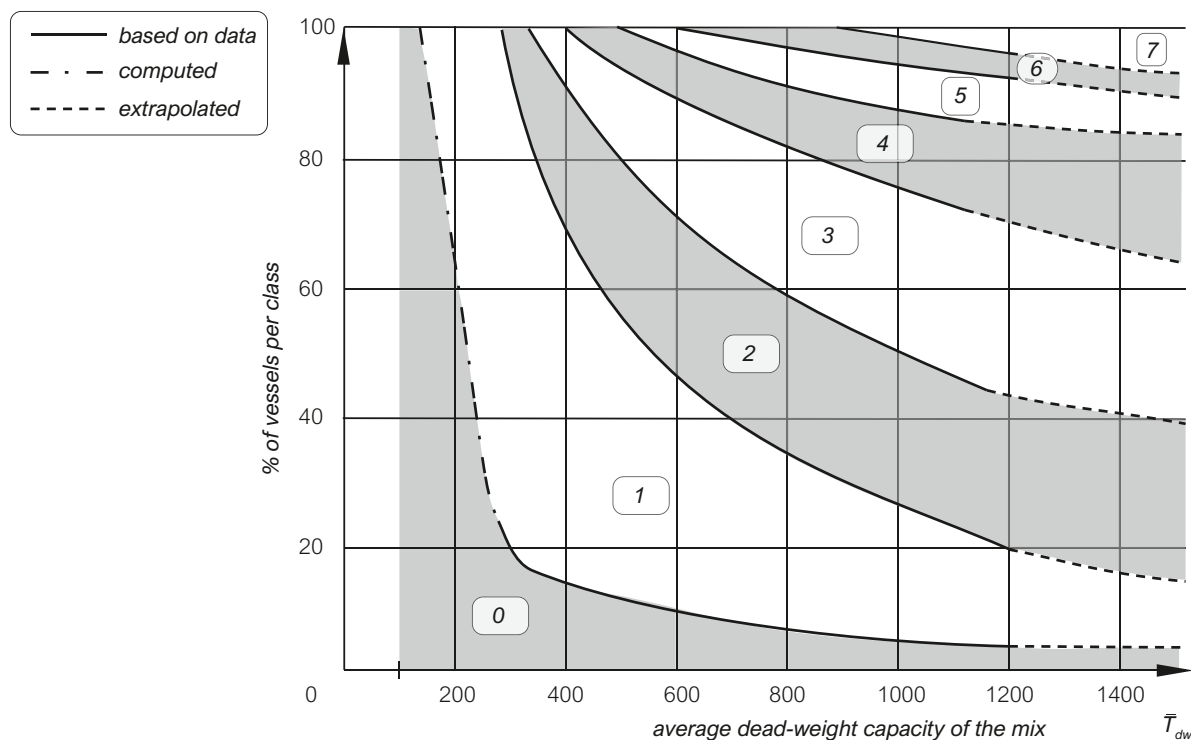

Figure 3.11: Percentage of vessels per class in a vessel mix with given \bar{T}_{dw} (by TU Delft – Ports and Waterways is licenced under CC BY-NC-SA 4.0).

Table 3.2 gives the same information in numbers. Table 3.3 gives alternative fleet compositions for channels of a lower navigability class.

In many cases this standard classification for ships was insufficient, and a more sophisticated classification had to be applied, as in the case of traffic control studies on the major rivers (see Table 3.4).

For various average dead-weight capacities (\bar{T}_{dw}) the average entry following times (t_i) and exit following times (t_u) are determined as a function of the area of the wet chamber cross-section (A_{lock}), using the standard frequency distribution from Table 3.2. This was done for both loaded and unloaded ships. Figure 3.12 gives the results, showing that for a given \bar{T}_{dw} :

$$t_i \text{ (loaded)} > t_i \text{ (unloaded)} > t_u \text{ (loaded)} > t_u \text{ (unloaded)}$$

| \bar{T} (ton) | Percentage of standard vessels per class | | | | | | | |
|--------------------|------------------------------------------|------|------|------|------|-----|-----|-----|
| | 0 | 1 | 2 | 3 | 4 | 5 | 6 | 7 |
| 125 | 100,0 | - | - | - | - | - | - | - |
| 160 | 82.5 | 17.5 | - | - | - | - | - | - |
| 200 | 62.5 | 37.5 | - | - | - | - | - | - |
| 240 | 42.5 | 57.5 | - | - | - | - | - | - |
| 280 | 22.5 | 77.5 | - | - | - | - | - | - |
| 300 | 20.0 | 73.0 | 7.0 | - | - | - | - | - |
| 350 | 17.5 | 62.5 | 16.0 | 4.0 | - | - | - | - |
| 400 | 15.4 | 54.2 | 20.9 | 9.0 | 0.5 | - | - | - |
| 450 | 13.5 | 48.0 | 24.5 | 11.0 | 3.0 | - | - | - |
| 500 | 12.0 | 43.2 | 26.1 | 13.0 | 4.6 | 0.9 | - | - |
| 600 | 9.3 | 36.7 | 27.0 | 17.0 | 5.6 | 4.4 | - | - |
| 700 | 7.2 | 33.0 | 25.4 | 20.4 | 7.3 | 5.6 | 1.1 | - |
| 800 | 6.0 | 30.0 | 24.0 | 22.5 | 9.0 | 6.4 | 2.1 | - |
| 900 | 5.0 | 26.2 | 24.5 | 23.8 | 10.5 | 6.5 | 2.9 | 0.6 |
| 1000 | 4.5 | 23.0 | 24.7 | 24.3 | 12.5 | 6.5 | 2.9 | 1.6 |
| 1100 | 4.5 | 19.5 | 25.0 | 25.0 | 14.0 | 6.5 | 3.0 | 2.5 |
| 1200 | 4.5 | 16.5 | 24.5 | 26.0 | 15.0 | 7.0 | 3.0 | 3.5 |
| 1300 | 4.5 | 14.5 | 25.0 | 25.0 | 16.5 | 7.2 | 2.8 | 4.5 |
| 1400 | 4.5 | 12.5 | 25.0 | 24.5 | 18.0 | 7.0 | 3.0 | 5.5 |
| 1500 | 4.5 | 10.5 | 25.0 | 23.5 | 20.0 | 7.0 | 3.0 | 6.5 |

Table 3.2: Fleet composition for a given \bar{T}_{dw} (by TU Delft – Ports and Waterways is licenced under CC BY-NC-SA 4.0).

| \bar{T} (ton) | Percentage of standard vessels per class | | | | | | | |
|--------------------|------------------------------------------|------|------|------|------|------|------|---|
| | 0 | 1 | 2 | 3 | 4 | 5 | 6 | 7 |
| | A. navigability class 4 | | | | | | | |
| 500 | 12.0 | 42.0 | 27.0 | 13.0 | 6.0 | - | - | - |
| 600 | 8.5 | 32.0 | 31.0 | 17.0 | 11.5 | - | - | - |
| | B. navigability class 5 | | | | | | | |
| 700 | 7.0 | 29.0 | 27.0 | 22.0 | 8.0 | 7.0 | - | - |
| 800 | 5.0 | 24.0 | 25.0 | 25.0 | 10.5 | 10.5 | - | - |
| 900 | 4.0 | 18.5 | 23.0 | 27.0 | 13.5 | 14.0 | - | - |
| 1000 | 3.0 | 14.0 | 21.0 | 28.0 | 16.0 | 18.0 | - | - |
| | C. navigability class 6 | | | | | | | |
| 1000 | 3.0 | 22.0 | 24.0 | 26.0 | 11.0 | 8.0 | 6.0 | - |
| 1200 | 2.0 | 16.0 | 22.0 | 29.0 | 11.0 | 10.0 | 10.0 | - |
| 1400 | 2.0 | 10.0 | 19.0 | 32.0 | 11.0 | 12.0 | 14.0 | - |

Table 3.3: Fleet composition for a given \bar{T}_{dw} at lower-class fairways (by TU Delft – Ports and Waterways is licenced under CC BY-NC-SA 4.0).

| Description | tonnage | category | % of weekly total | |
|-----------------------------------------------------------------------|-------------|----------|-------------------|------|
| | | | 1972 | 1973 |
| Motor cargo or motor tanker vessel | < 450 | 1 | 18.9 | 13.5 |
| | 450-750 | 2 | 23.9 | 20.9 |
| | 750-1149 | 3 | 23.4 | 23.5 |
| | 1150-1549 | 4 | 11.2 | 15.9 |
| | 1550-2549 | 5 | 3.8 | 3.9 |
| | > 2550 | 6 | 0.1 | 0.5 |
| Pushed convoy or pushing motor vessel | < 5000 | 7 | 4.0 | 3.0 |
| Cargo or motor tanker vessel | ≥ 5000 | 8 | 3.6 | 4.4 |
| Single towed cargo ship, or towed tanker ship, or coupled towed ships | < 1000 | 9 | 0.4 | 0.4 |
| | ≥ 1000 | 10 | 3.6 | 1.9 |
| Motor vessel with towed ship, or Motor vessel adjacently coupled | < 1000 | 11 | 0.2 | 0.6 |
| | ≥ 1000 | 12 | 0.0 | 1.9 |
| Ocean-going vessel | | 13 | 1.8 | 1.8 |
| Working vessel, towed object | | 14 | 0.3 | 0.2 |
| Individual towing/pushing or fishing vessel | | 15 | 2.1 | 1.6 |
| Passenger vessel | | 16 | 0.9 | 1.2 |
| Pleasure craft | | 17 | 1.8 | 4.8 |

The weekly total observed for both navigation directions on the river Waal east of Nijmegen in the period 12 to 19 June 1972 amounted to: 3598 ships, and in the period 19 to 26 June 1973: 3562 ships.

Table 3.4: Observed occurrence of vessels per class on the river Waal east of Nijmegen (by TU Delft – Ports and Waterways is licenced under CC BY-NC-SA 4.0).

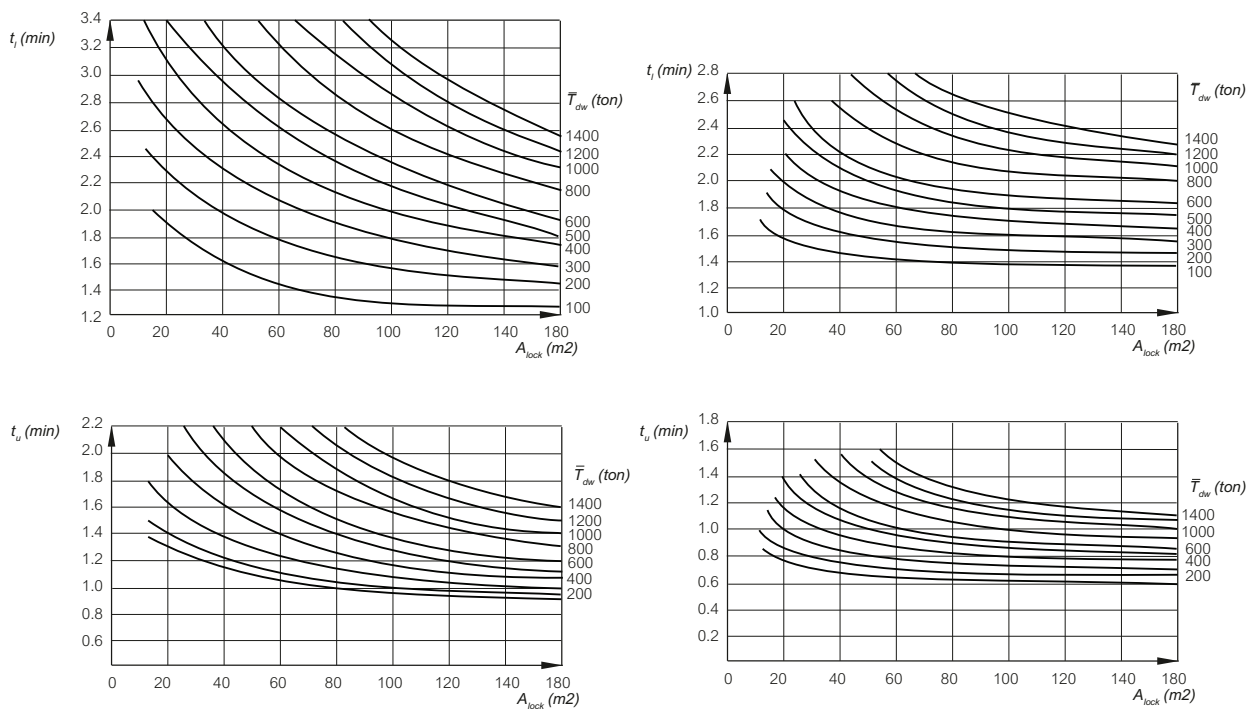

Figure 3.12: Entry and exit following times as a function of the cross-sectional area of the lock chamber (left: mix of loaded vessels, right: mix of unloaded vessels) (by TU Delft – Ports and Waterways is licenced under CC BY-NC-SA 4.0).

3.1.3 Loop time

As stated before, the loop time is defined as the time that elapses between the moment the last ship of the previous locking cycle leaves the lock and the moment the stern of the first ship passes the lock sill.

Just as for the individual entry and exit times, the loop time t_l is also a function of the loading status of a vessel (loaded or unloaded), the dead-weight capacity and the chamber cross-section. Furthermore, the loop time depends on the distance from the stern of the first vessel in the waiting area to the entrance gate and actually consists of two parts:

$$t_l = t_l(\text{departing ship}) + t_l(\text{entering ship}) \quad (3.13)$$

From observations it appears that $t_l(\text{entering ship})$ is much larger than $t_l(\text{departing ship})$. The release and acceleration of the entering vessel easily takes up the greatest part of the loop time, also because the skipper has to anticipate the slow-down and positioning in the lock chamber. This is why in practice the loop time is based on the first entering vessel only:

$$t_l = t_i(A_s/A_{lock}) + \Delta t(S_l) \quad (3.14)$$

So in this approximation the loop time is equal to the entry following time (a function of the blockage coefficient) and a correction for the extra time the first vessel requires, which is a function of the loop distance S_l as defined in Figure 3.4. Figure 3.13 gives this relationship for loaded and unloaded vessels.

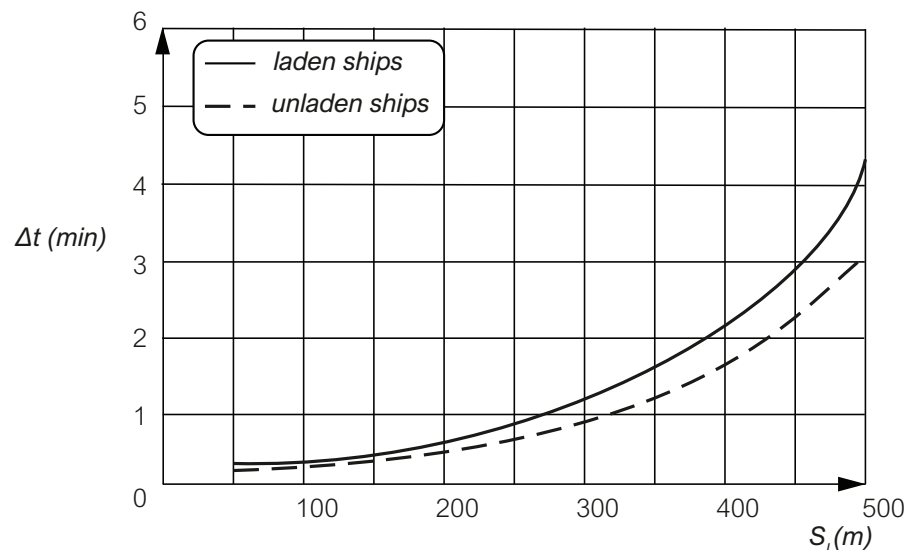

Figure 3.13: Extra time for the first vessel, as included in the loop time (by TU Delft – Ports and Waterways is licenced under CC BY-NC-SA 4.0).

3.1.4 Vessels in the lock chamber

It is possible to establish the maximum number of ships in the lock chamber by using a simulation on the basis of a specific fleet distribution. Some locks use a computer program to determine the optimum lock arrangement. If this is the case, lock operators try to maintain a distance between individual ships of 3% of the ship's length in the longitudinal direction and 1 to 2% of the chamber width in the transverse direction. Different criteria apply for establishing the maximum number of ships in the lock chamber of a maritime lock. Maritime vessels are, for example, always moored immediately alongside the lock walls.

Figure 3.14, Figure 3.15 and Figure 3.16 give the maximum number of ships in a lock chamber of given length and width as a function of the average dead-weight capacity. The fleet composition as a function of the average dead-weight capacity is the same as in Figure 3.11 and Table 3.2.

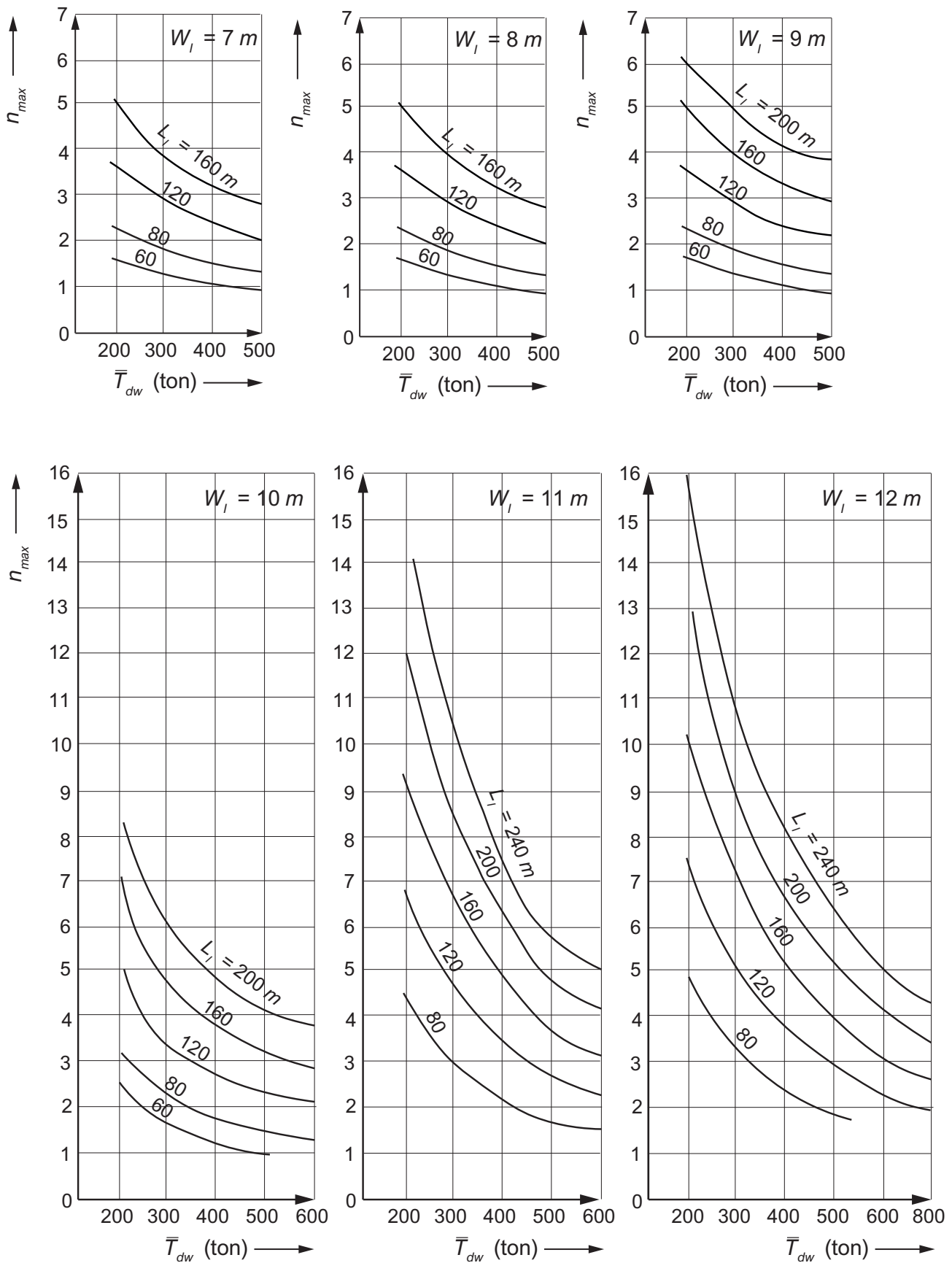

Figure 3.14: Maximum number of ships in a lock chamber, given the length and width of the chamber (by TU Delft – Ports and Waterways is licenced under CC BY-NC-SA 4.0).

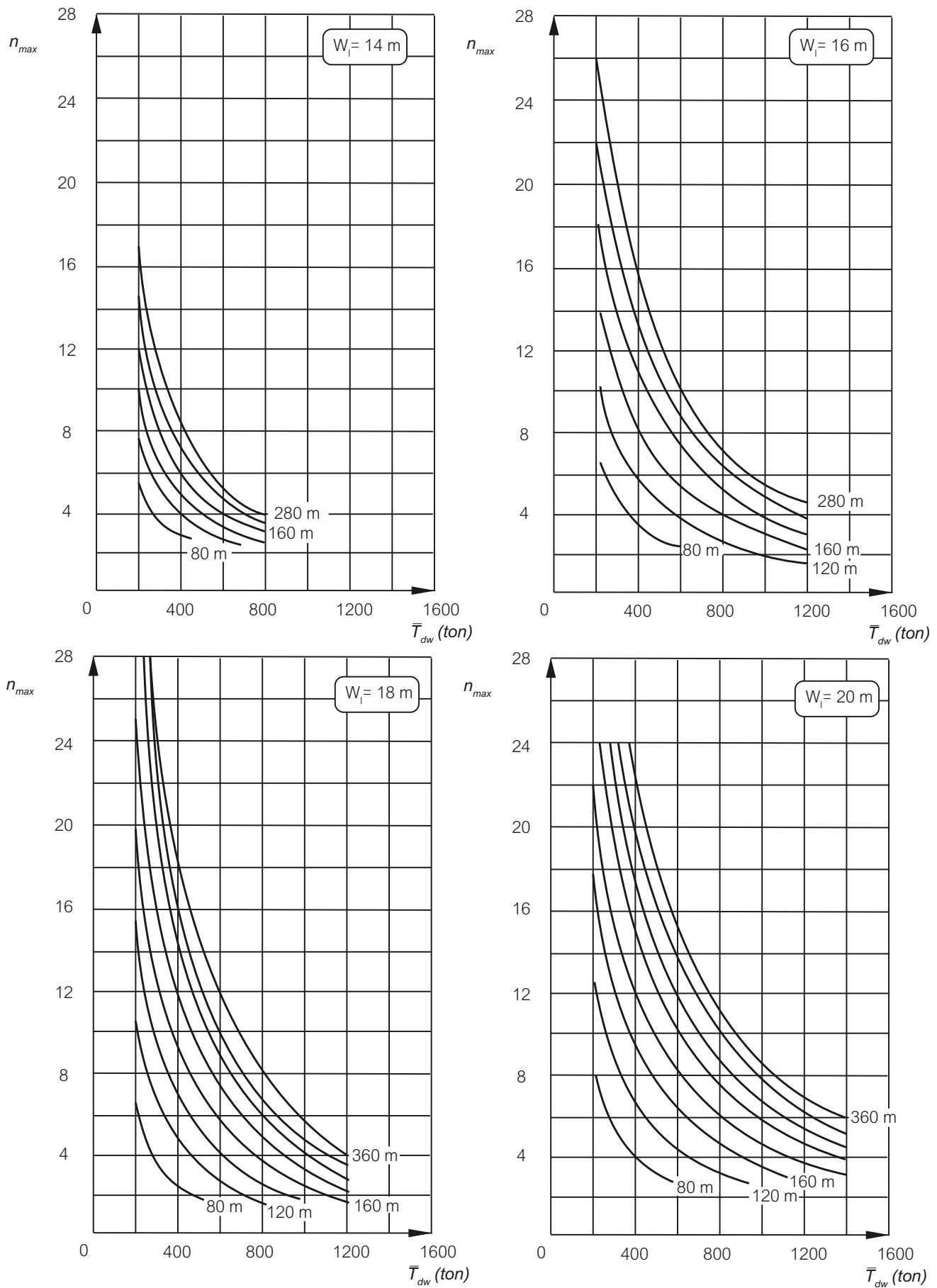

Figure 3.15: Maximum number of ships in a lock chamber, given the length and width of the chamber (by TU Delft – Ports and Waterways is licenced under CC BY-NC-SA 4.0).

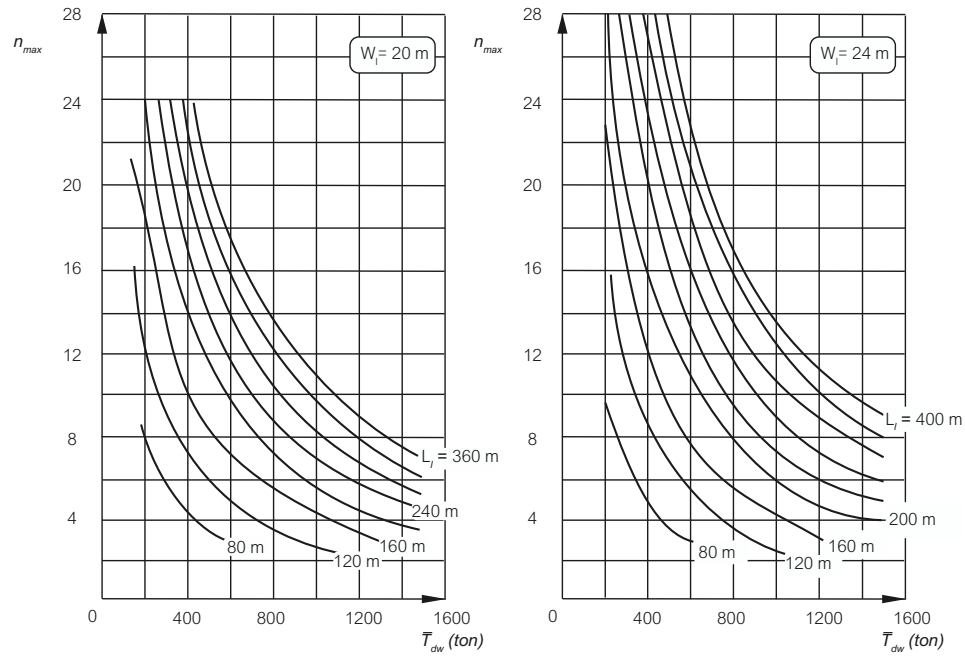

Figure 3.16: Maximum number of ships in a lock chamber, given the length and width of the chamber (by TU Delft – Ports and Waterways is licenced under CC BY-NC-SA 4.0).

3.1.5 Lock capacity

We will show how the locking capacity of inland waterways is calculated in three different cases:

1. always locking in two directions with fully occupied chambers;
2. always locking in one direction with fully occupied chambers and in the other direction with partially occupied chambers; and
3. always locking in one direction with fully occupied chambers (one-way traffic).

We will elaborate the first case and see what changes in the second and third case.

The fleet composition plays a role in a number of elements determining the lock capacity. Table 3.5 gives the composition used in the present example. Vessels are either fully loaded (70%) or fully unloaded (30%). The dimensions of the lock considered in this example are given in Figure 3.17.

The lock has mitre gates with sluice openings of a total of 2 m^2 in each door (so $A_{sl} = 4 \text{ m}^2$) for filling and emptying the lock chamber. The energy losses are low, but not negligible. The loop distance is $S_l = 400 \text{ m}$.

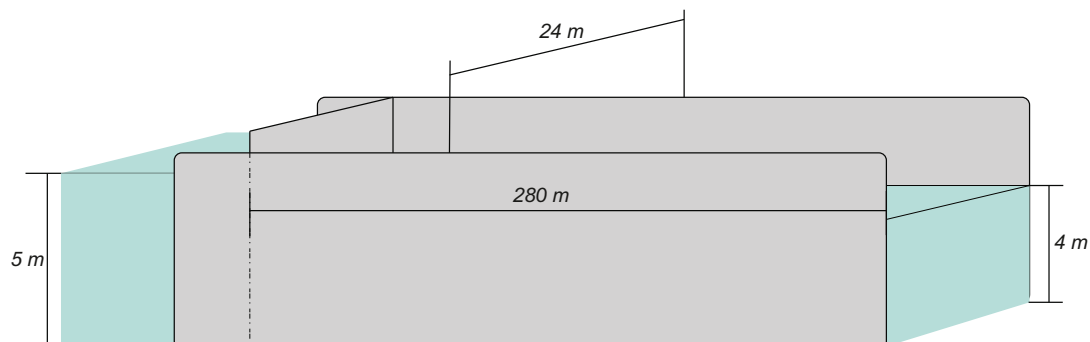

Figure 3.17: Lock dimension for lock capacity calculation (by TU Delft – Ports and Waterways is licenced under CC BY-NC-SA 4.0).

| | P_s (%) | $T_{average}$ (tons) | $P_s \cdot T_{average}$ (tons) |
|--------------|--------------|-------------------------|-----------------------------------|
| | 6 | 125 | 7.5 |
| | 30 | 325 | 97.5 |
| | 24 | 550 | 132.0 |
| | 22.5 | 925 | 208.1 |
| | 9 | 1350 | 121.5 |
| | 6.4 | 2000 | 128.0 |
| | 2.1 | 4100 | 86.1 |
| Total | 100 | | 780.7 |

Table 3.5: Fleet data for lock capacity calculation (by TU Delft – Ports and Waterways is licenced under CC BY-NC-SA 4.0).

Example box 3.1: Lock capacity calculations

Step 1: Maximum number of vessels in the lock chamber

Given the fleet data for T_{dw} in Table 3.5, the maximum number of vessels in the lock chamber follows from Figure 3.14, Figure 3.15 and Figure 3.16 for the relationships between the lock width, the lock length and the overall mean tonnage (780.7 tons according to Table 3.5). In this case, $n_{max} = 12$.

Step 2: Operating time

$$T_{op} = T_{close} + T_{waterlevel} + T_{open}$$

Table 3.1 gives: $T_{close} = 2.5$ min and $T_{open} = 2.6$ min

The time needed to adjust the water level follows from

$$T_{waterlevel} = \frac{2W_l L_{lock} H}{mA_{sl} \sqrt{2gh}}$$

With chamber width $W_l = 24$ m, chamber length $L_{lock} = 280$ m, head difference $H = 1$ m, discharge coefficient $m = 0.8$, sluice area $A_{sl} = 4$ m² and gravity acceleration $g = 9.81$ m/s² this yields approximately 14 min.

So the operating time amounts to $2.5 + 14 + 2.6 = 18.1$ min.

Step 3: Downstream entry, exit and loop times

Given the cross-sectional area of the lock chamber ($A_{lock} = 5 \times 24 = 120$ m²) and the average tonnage, t_i follows from Figure 3.12. For loaded vessels this is 2.4 min, for unloaded vessels 1.85 min. Since 70% is loaded, the average value is 2.24 min.

The exit time t_u follows from the same figures, but now with $A_{lock} = 4 \times 24 = 96$ m². This yields an average value of 1.4 min.

The loop time $t_l = t_i + \Delta t$, where Δt follows from Figure 3.14. For $S_l = 400$ m this yields 2.1 min for loaded vessels and 1.8 min for unloaded ones, so 2 min on average. Hence the loop time is $2.24 + 2.00 = 4.24$ min.

Step 4: Downstream locking duration

$$T_{d(down)} = t_l + (n - 1) t_i + T_{operation} + n t_u = 4.24 + (12 - 1) 2.24 + 18.1 + 12 \times 1.4 = 63.8 \text{ min}$$

Step 5: Upstream locking duration

Following the same steps as above yields:

$$t_l = 4.43 \text{ min}; t_i = 2.43 \text{ min}; T_{operation} = 18.1 \text{ min}; t_u = 1.28 \text{ min}; T_{d(up)} = 64.6 \text{ min}$$

Example box 3.1 – continued on next page

Example box 3.1 – continued from previous page

Step 6: Total cycle times

$$T_c = T_{d \text{ (up)}} + T_{d \text{ (down)}} = 128.4 \text{ min} = 2.14 \text{ hrs}$$

Step 7: Lock capacity

$$C_s = 2 n_{max} / T_c = 2 \times 12 / 2.14 = 11.21 \text{ ships/hr}$$

$$C_T = T_{dw} C_s = 780.7 \times 11.21 = 8751 \text{ tons/hr}$$

If the lock chamber is only partly occupied, the procedure is:

- (a) for the direction for which the capacity is to be calculated n_{max} applies; for the opposite direction $n < n_{max}$ applies;
- (b) T_d is calculated for the first direction on the basis of n_{max} and for the opposite direction on the basis of n ;
- (c) the capacity is determined for each direction, i.e. $C_s = n_{max} / T_c$ for the first direction and $C_s = n / T_c$ for the opposite direction.

In case of one-way traffic, the procedure changes as follows:

- (a) The loop time is shorter because the first ship does not have to wait until the last ship of the previous cycle has passed the waiting area;
- (b) $T_c = T_d$, in the lock direction + $T_{operation}$;
- (c) The capacity follows from $C_s = n_{max} / T_c$.

The locking capacity derived in the previous section is based on a full lock chamber in every cycle. If in the lock design phase, this capacity would be chosen equal to the average traffic intensity, but unacceptable waiting times would be the result. The variation in traffic intensity occurring in practice, combined with a limited acceptable waiting time, requires a higher locking capacity.

The variations in traffic intensity are partly systematic, partly random (see Figure 3.18). The systematic variation is a combination of daily and weekly cycles. The traffic intensity is high during the day and low during the night, high during weekdays and low in the weekends.

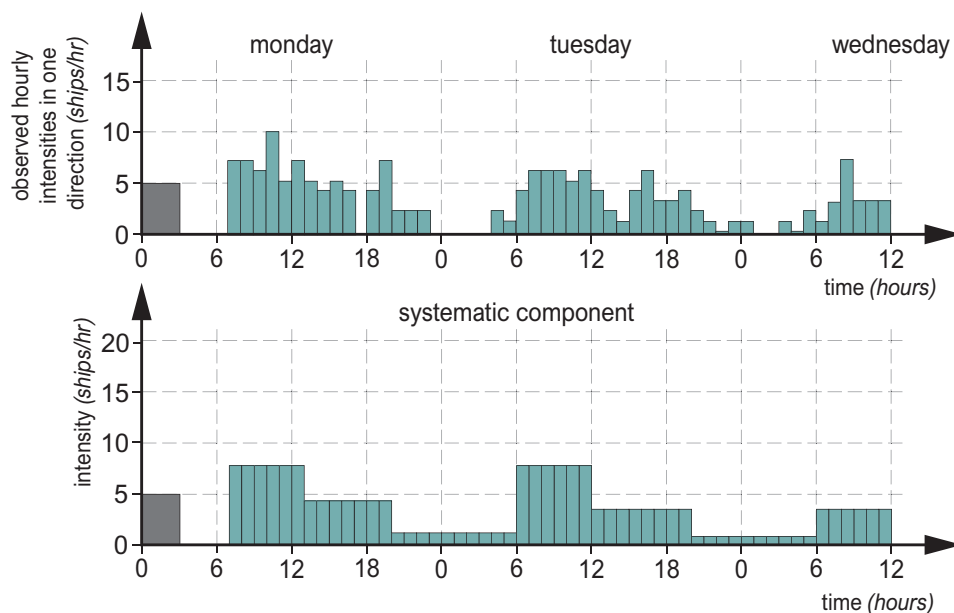

Figure 3.18: Traffic intensity variation (by TU Delft – Ports and Waterways is licenced under CC BY-NC-SA 4.0).

Simulation models can be used to determine waiting times. [Figure 3.19](#) qualitatively indicates how waiting times increase with the average I/C -ratio. As a result of the large intensity variations, unacceptable delays may already occur at low I/C -values. Hinder for navigation occurs if the average total waiting time exceeds 30 minutes in the busiest months. As an example: the I/C ratio at the Kreekrak locks is then about 0.55 and the intensity about 150 to 200 mln ton/year ([RVW, 2020](#)). The average passing time is about 45 to 60 minutes.

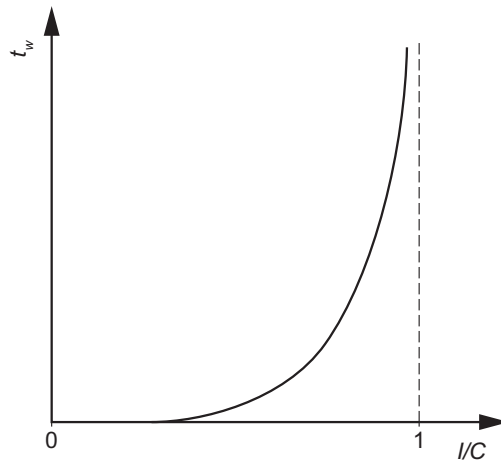

Figure 3.19: Average waiting time as a function of the average intensity/capacity ratio on a weekly basis (by TU Delft – Ports and Waterways is licenced under CC BY-NC-SA 4.0).

3.2 Lock dimensions

An important source of information for lock dimensions - as far as the Dutch waterways are concerned - are Rijkswaterstaat's Waterway Guidelines 2020 ([RVW, 2020](#)). In 2009 and 2019 PIANC issued design guidelines for locks and their approach areas ([PIANC, 2009, 2019a](#)), based on the national guidelines of the member states. They don't conflict with [RVW \(2020\)](#).

[RVW \(2020\)](#) gives guidelines for the dimensions of locks for commercial shipping, for recreational traffic, and for mixed traffic, including the approach and waiting areas. An important proviso is that these are guidelines, not a recipe applicable to every situation. The design of this kind of large infrastructure needs to be adapted to the local situation.

3.2.1 Locks for commercial traffic

[Figure 3.20](#) shows the most important characteristics of the entrance and chamber parts of a lock system.

Lock chamber The actual dimensions of a lock depend on the size of the normative vessel. [Table 3.6](#) gives the lock chamber dimensions as a function of the vessel class.

In this table, the threshold depth is defined as the draught of the normative vessel plus the required keel clearance. Since locks are designed for a life-time of typically 100 years, the possibility of lower water levels in the future due to bed erosion should also be taken into account.

The width given in this table is based on the assumption that strong guide fenders are present at the entrance of the lock chamber. If not, the lock and its entrance have to be wider.

Lock approach area [RVW \(2020\)](#) recommends locating the axis of the lock approach in line with the axis of the lock chamber. Furthermore, the lock approach should be straight. As indicated in [Figure 3.20](#) it consists of four parts, which we will describe successively.

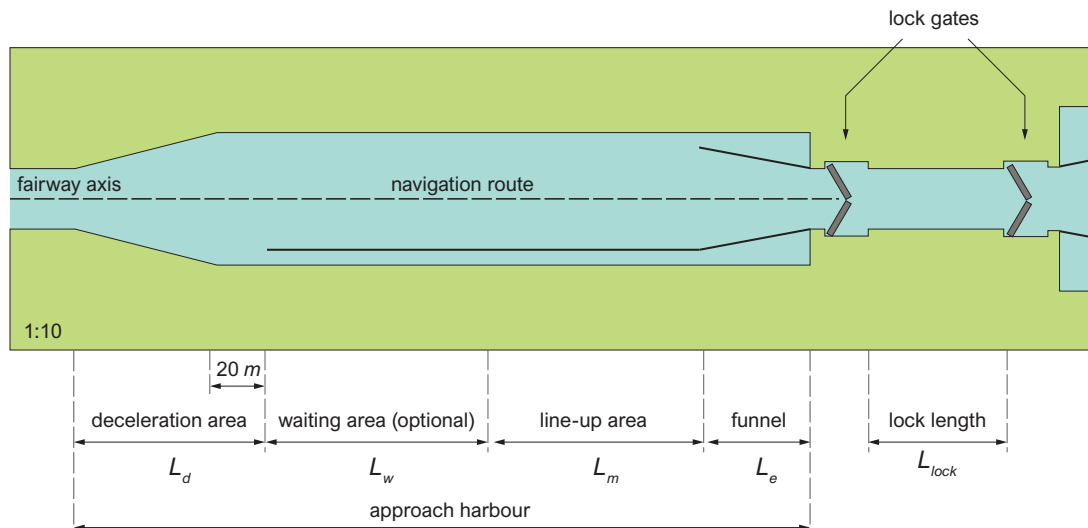

Figure 3.20: Lock approach area and chamber characteristics (image reworked from RVW, 2020, by TU Delft – Ports and Waterways is licenced under CC BY-NC-SA 4.0).

| Class CEMT | Lock length [m] | Chamber width [m] | Threshold depth [m] |
|------------|-----------------|-------------------|---------------------|
| I | 43 | 6.0 | 2.8 – 3.1 |
| II | 60 | 7.5 | 3.1 – 3.2 |
| III | 80 – 95 | 9.0 | 3.1 – 3.3 |
| IV | 95 – 115 | 10.5 | 3.5 – 3.7 |
| Va | 125 – 150 | 12.5 | 4.2 |
| Vb | 210 | 12.5 | 4.7 |
| VIa | 160 | 23.8 | 5.0 |
| VIb | 210 | 23.8 | 5.0 |

Table 3.6: Lock dimensions for commercial shipping (RVW, 2020).

The length of the *deceleration area* must be sufficient to allow a vessel entering the lock approach to slow down. The length required depends on the local circumstances, the characteristics of the vessel and its initial speed. In general, it amounts to at least 2.5 times the length of the normative vessel.

The *waiting/lay-by area* is optional. It is only needed if mooring up is necessary on a regular basis, or if a separate waiting/marshalling area has to be created for ships with hazardous loads. Given that the waiting area has to be in line with the marshalling area, its width will be the same as that of the marshalling area.

The *marshalling area* must offer space to the same number of vessels as can be locked in one operation. The width of the marshalling area must therefore be equal to the width of the lock chamber. The length of this area can be taken to be 1.0 – 1.3 times the length of the lock chamber.

The *lock entrance* fulfils three functions for the ships entering the lock:

- providing visual guidance;
- providing physical support/guidance for the front part of the vessel if this is not correctly aligned with the lock axis;
- keeping vessels, when lying drifted (oblique), from becoming trapped in the lock head.

The depth of the entire lock approach must be equal to that of the connecting waterway and greater than the threshold depth, in order to prevent sedimentation problems in the approach area.

3.2.2 Locks for recreational traffic

[RVW \(2020\)](#) recommends using a separate (yacht) lock if there are more than 10,000 commercial passages per year on a waterway with mixed traffic. The dimensions of the yacht lock will depend on:

- the intensity of the recreational traffic;
- the dimensions of the yachts;
- the dimensions of the maintenance equipment;
- the type of recreational traffic (motor, sail or combined);
- whether it serves as a back-up for the commercial shipping lock.

Like in commercial shipping, recreational vessels are divided into classes and the dimensions of a lock are based on a normative vessel class. Due to the wide variety of types and sizes of recreational vessels, the division made is exclusively based on the yacht dimensions. For each class, these dimensions have been selected in such a way that only 5% of the vessels exceed the length, width or draught. [RVW \(2020\)](#) mentions different recreational classes, depending on the sailing area and type of yacht. Also European classes are given. Note that sailing yachts can have an air draught up to 30 m due to their mast. A particular category is the so-called brown fleet, a fleet of original 19th century ships, usually with brown sails; see [Table 3.7](#).

| Class | Height | Draught | Width | Length |
|-------|--------|---------|-------|--------|
| BV1 | >12.00 | 1.20 | 5.50 | 25.00 |
| BV2 | >12.00 | 1.40 | 6.50 | 30.00 |

Table 3.7: Normative ship dimensions - brown fleet (charter fleet) ([RVW, 2020](#)).

To determine the required lock dimensions, simulation models can be used. For commercial shipping locks, simulation models only have to be used if the traffic volume exceeds 10,000 vessels per year. For yacht locks, however, the design should always be based on simulation. Yet, some indicative dimensions can be provided:

- the threshold depth = the draught + 0.4 m;
- locks for up to 10,000 recreational vessels per year must be large enough to accommodate four vessels (two wide and two long).

3.2.3 Locks for mixed traffic

In case of mixed commercial and recreational traffic, the possibility of constructing a separate yacht lock should first be explored (see [Section 3.2.2](#)). If this is not possible (financially or spatially), a lock for mixed traffic can be considered.

Due to the small dimensions of yachts relative to commercial vessels, the size of recreational craft does not constitute a problem: recreational vessels can easily be accommodated in a lock chamber for the smallest commercial vessels ([CEMT Class I](#)). The only problem in mixed locking is the number of yachts to be accommodated in the chamber together with one or more commercial vessels. Measures are required to allow the lock to function safely. Chamber enlargement (lengthening or widening; [Figure 3.21](#)) is a good solution, yielding more space between the recreational and commercial vessels. A widened chamber has advantages over a lengthened one:

- the capacity for commercial shipping becomes significantly larger in winter times when recreational traffic is low;
- pleasure craft suffer less from turbulence caused by the propellers of the commercial vessel(s).

Yet, there are also disadvantages:

- the construction of such a lock is more expensive;
- the safety of the recreational vessels may sooner become an issue.

In view of the higher safety level, [RVW \(2020\)](#) recommends lengthening the lock, in which case the commercial vessels are supposed to depart slowly, thus keeping propeller-induced turbulence at a minimum.

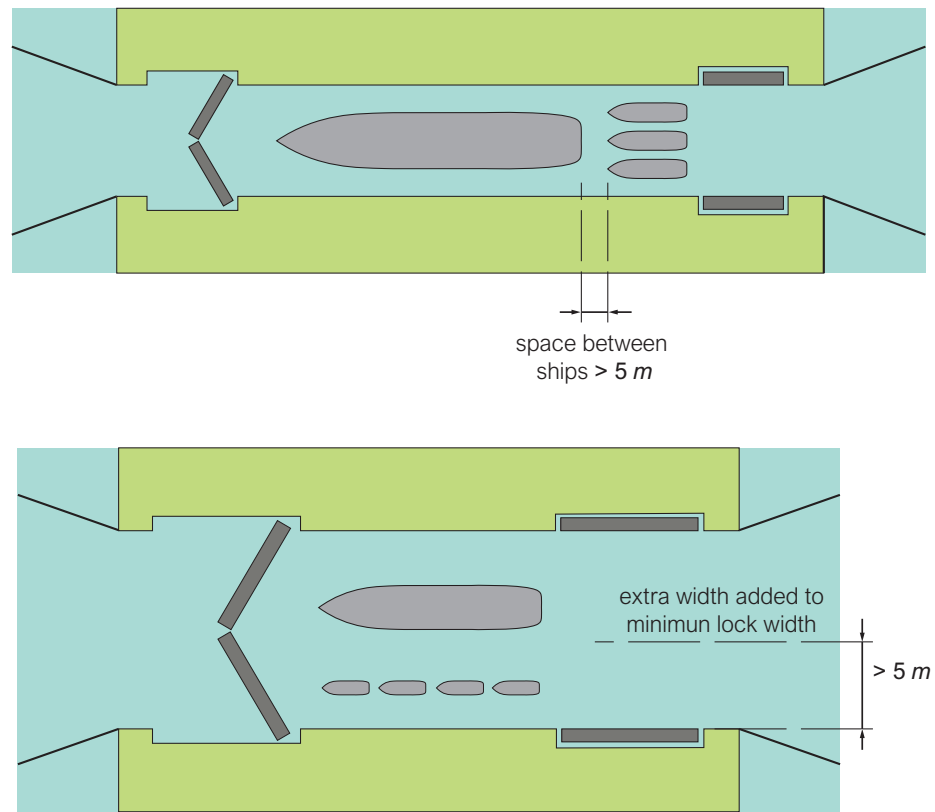

Figure 3.21: Two types of lock enlargement (image reworked from RVW, 2020, by TU Delft – Ports and Waterways is licenced under CC BY-NC-SA 4.0).

The lock approach for mixed traffic needs several modifications:

- if there is a lot of recreational traffic, it is advisable to create a separate marshalling area (see Figure 3.22);
- in case of a single-sided marshalling area for commercial shipping, the marshalling area for recreational traffic should be on the other side and as close to the lock as possible.

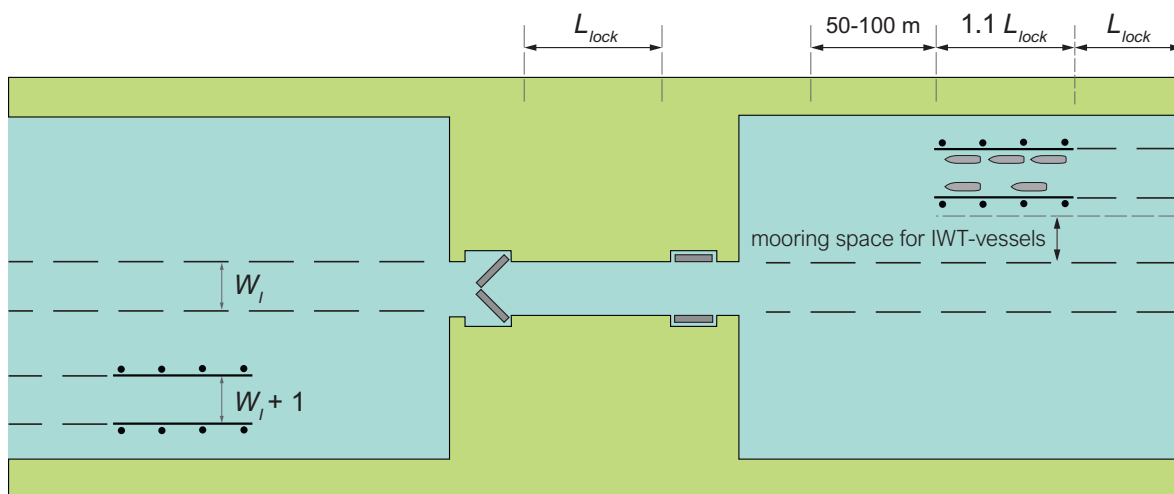

Figure 3.22: Schematic layout marshalling area with boxes for recreation traffic (image reworked from RVW, 2020, by TU Delft – Ports and Waterways is licenced under CC BY-NC-SA 4.0).

3.2.4 Safety lock gates

Safety lock gates (Figure 3.23, left) are part of both the waterway and the flood defence system, and must therefore meet the requirements of their flood defence function as well as those for the waterway function. When closed, the gate must function as a fully-fledged flood defence structure. For dimensions and design guidelines regarding the flood defence function in the Netherlands, we refer to Rijkswaterstaat's Helpdesk Water (<https://www.helpdeskwater.nl/>).

On waterways that may not be blocked, a lift lock may be installed instead of safety lock gates. A lift lock is open most of the time, except during floods. On busy waterways, safety lock gates with a lift lock alongside must always be chosen. The lift lock may be equipped with basic fittings and a 'green lock chamber' (i.e. with grass-covered slopes instead of vertical sidewalls; see Figure 3.23, right).



Figure 3.23: Left: Lift lock Kromme Nol near Heusden, Netherlands (*Kromme nolkering 1* by Hullie is licenced under CC BY-SA 3.0); Right: Green lock chamber, Wilhelminasluis near Andel, Netherlands (*Netherlands, Afdamde Maas, Wilhelminasluis* by Vincent van Zeijst is licenced under CC BY-SA 3.0).

The axis of the lock must coincide with that of the waterway section in which it is situated, to provide a good view of oncoming traffic and to allow vessels to pass in a straight line. This also leaves room for a waiting area.

The cross section of a lock with safety lock gates is based on a rectangular shape. If more than 15,000 commercial vessels pass per year, the lock must have the same navigable width as the waterway to ensure fully uninterrupted navigation. In less busy waterways it is the competent authority's discretion to allow a slight reduction (up to 10%) of the width. In that case, overhauling and passing in the lock are assumed to be avoidable. Where there is a single-lane profile, the minimum lock width for vessels up to Class Va is $1.6 B_s$ (B_s = beam of reference vessel). A width of $1.7 B_s$ applies to class Vb if the units are equipped with a bow thruster, and $2.0 B_s$ otherwise.

In case of existing waterways, the existing width is starting point for the design of the safety lock gate. For longitudinal currents > 0.5 m/s (rivers) an additional width should be applied per shipping lane. For all classes, at least 1.4 times the draught of the reference vessel is required for the sill depth and above the ground sills. Only for narrow and single-lane profiles, a factor 1.3 applies.

Where the passage is long, an increment is applied to the width. This increment varies linearly from 0 if the passage length is less than $0.3 L_s$ (L_s = the length of the reference vessel) to $0.02 L_s$ for a passage length of $0.7 L_s$ or more.

At safety lock gates with an adjacent lift lock, waiting areas, marshalling areas and guide fenders must be provided. If there is no lift lock, waiting areas must be provided to prevent blockage of the waterway. Where there is a normal or narrow profile, no guide fenders are required, but protective structures are required before any elements susceptible to collision. Guide fenders must be provided where there is a single-lane profile.

Apart from flood gates and lift locks that are only closed during floods, there are also 'common' locks with a flood defence function. They are located in a flood defence separating water bodies with different water levels under normal conditions, or with fresh and saline waters (see, for instance, Figure 3.24). The design of such locks is largely the same as for locks without a flood defence function, except that the doors and the plateau in the flood retaining lock head have to meet special requirements, such as height, back-up closure facilities, etc.

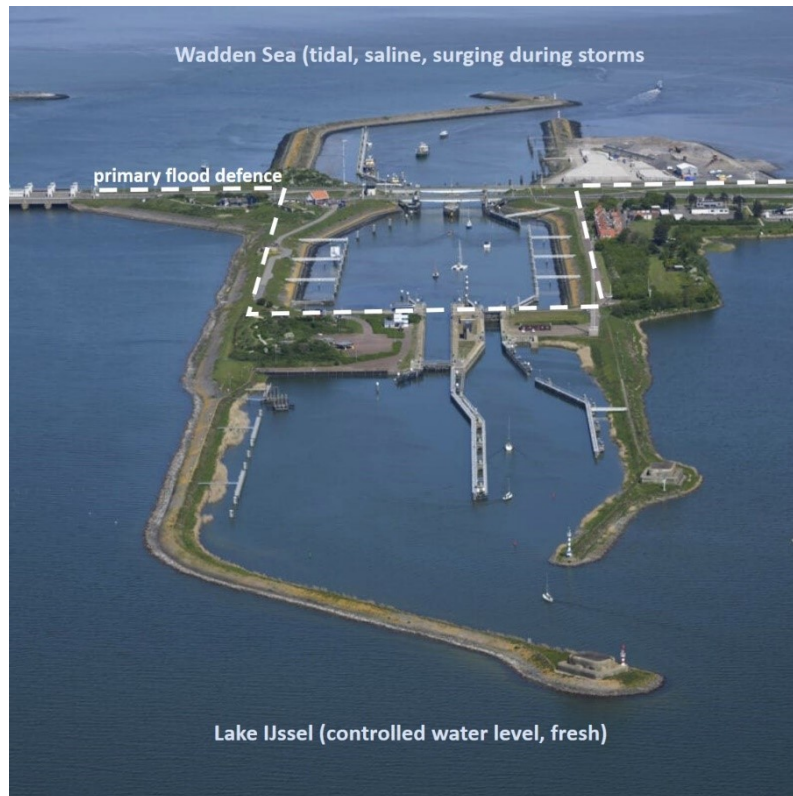

Figure 3.24: Navigation locks in the Afsluitdijk at Kornwerderzand (“Afsluitdijk overview prior to project start” by Royal Van Oord is licensed under CC BY-NC-SA 4.0).

3.2.5 Locks at weirs

If a navigable river is provided with a weir or navigation-blocking obstacle, traffic bypasses via a lock. The canal leading to and from the lock must branch off from the main fairway at a sufficient distance from the lock, in order to enable vessels to safely leave or enter the river’s mainstream. This requires special attention upstream of the weir. There the river section between the branching point and the weir (when closed) needs to be closed off for navigation, either by prohibitory signs (for channel less than 60 m wide), or by special marking lines with yellow barrels in case of wider channels.

That this is important became evident when in December 2016, during a dense fog, a tanker hit the weir in the river Maas near Grave, Netherlands. Not only was the weir structure damaged, but also the water level in the river section upstream and all connected waters was lowered (Figure 3.25). It took months before the old situation could be restored. Based on this accident [RVW \(2020\)](#) provides new guidelines.



Figure 3.25: Damage to the weir at Grave (left) and the consequences upstream (right) (left: [Stuw Grave aanvaring](#) by Nico van Lammeren is licenced under CC0 1.0; right: [BootAanBoot.NL](#), all rights reserved).

3.3 Bridges

Important aspects of bridges are their location, the way they cross the fairway, whether they are fixed or movable and the guidance and protection works. We will consider these aspects in the next sections.

3.3.1 Location

The location of a bridge is determined not only by nautical arguments, but also by factors such as the connecting infrastructure (road, railway), the environment (urban or rural) and the space available (designated or protected areas). If there is freedom of location, bridges should preferably cross the fairway perpendicularly and away from bends. If there is no other option than positioning a bridge in a bend, it has to meet specific requirements (see [RVW, 2020](#)). In straight reaches, bridges should be located at such distances apart that safe navigation is possible, i.e. (if L_s is the length of the reference vessel):

- skippers have enough time and distance ($3 L_s$) to correct the vessel's course if the bridge constitutes a hindrance in the fairway;
- successive movable bridges are either so close together that they can be considered as a single long passage (in which case they need to be opened and closed in tandem), or they are sufficiently far apart to enable vessels to safely slow down and moor if necessary (total distance needed $3 L_s$), and subsequently to accelerate and align with the fairway axis (total distance needed $1.5 L_s$);
- skippers of vessels with an adjustable wheelhouse, such as container ships, have enough time and distance (at least 500 m) to lower the wheelhouse before passing the bridge and lift it again afterwards;
- false radar signals are avoided as much as possible.

For fixed bridges without a pier in the fairway and a passage width equal to the total fairway width there is no requirement as to the distance between them, only that before and after a bend an straight section of $1.5 L_s$ is required. Such bridges are preferred in general, as there is no hindrance or risk for passing vessels, like piers. In fairway reaches with strong cross-winds, the distance between consecutive bridges has to be $3 L_s$. This distance also applies to bridges with a pier in the middle.

The preferred way of crossing a fairway is perpendicular but this is not always possible. In case of an oblique crossing, it is important that the axis of the passage coincides with the fairway axis. The substructure of the bridge and the guiding fenders should align with this, as indicated in [Figure 3.26](#).

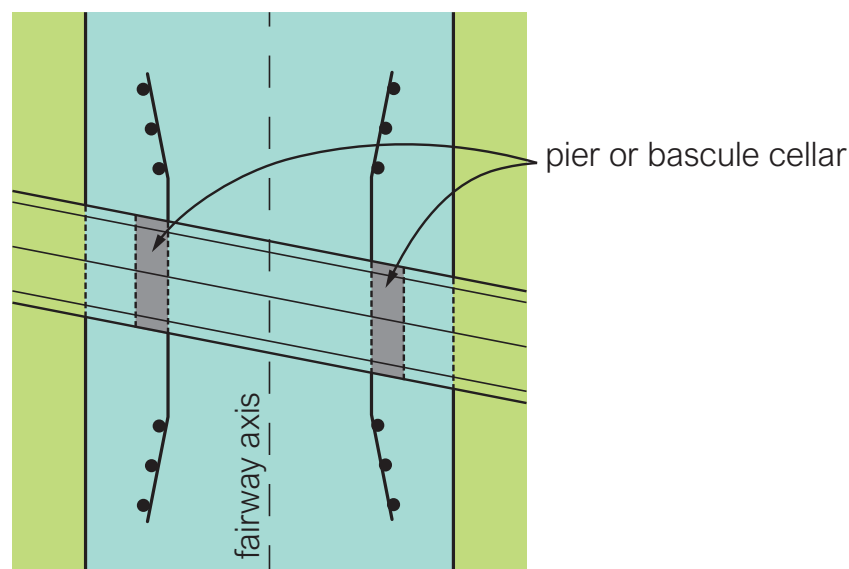

Figure 3.26: Oblique bridge crossing (reworked from [RVW, 2020](#), by TU Delft – Ports and Waterways is licenced under CC BY-NC-SA 4.0).

3.3.2 Fixed or movable?

RVW (2020) distinguishes fixed and movable bridges, for commercial and recreational navigation, with a normal, narrow or single-lane fairway profile. Fixed bridges of sufficient height are preferred, because they are cheaper, require less maintenance, need no operation and don't lead to waiting times for land and waterway traffic.

Yet, there are exceptions, because some waterways have been designated as free from height limitations. Among them are maritime accesses, waterways for high transports and the so-called 'standing mast' routes for recreational vessels. Such open waterways should be crossed via movable bridges (leading to waiting times), or via tunnels or aqueducts.

At waterways with a current of more than 0.5 m/s, fixed bridges are preferable, with sufficient headroom and a free spans, so without bridge piers in the navigable part of the waterway. If bridge piers are necessary, the navigable width shall not be less than that of existing or planned bridges in the vicinity.

Fixed bridges Fixed bridges for commercial navigation have a free span over the entire fairway width. In case of new bridges, the fairway profile may not be narrowed. For existing bridges reductions are allowed, depending on the type of fairway (see Figure 3.27).

| types of fixed bridge | commercial traffic | recreational traffic |
|------------------------|--------------------------------------------------------------------------------------|---------------------------------------------------------------------------------------|
| normal fairway profile |  |  |
| narrow fairway profile |  |  |
| single-lane profile |  | non-existent |

Figure 3.27: Overview of fixed bridges (reworked from RVW, 2020, by TU Delft – Ports and Waterways is licenced under CC BY-NC-SA 4.0).

The required headroom of a fixed bridge is the same for all three fairway profiles. The reference vessel must be able to pass the bridge without hindrance. The headroom H_B is defined as the distance between the local reference high water level and the underside of the fully laden bridge. The headroom required for navigation is given by:

$$H_B = D_{\text{air}, 90\%} + S \tag{3.15}$$

in which $D_{\text{air}, 90\%}$ is the air draught or height above the waterline not exceeded by 90% of the unladen vessels in a certain CEMT class and S is a safety margin. The table in Figure 3.28 gives an overview of the headroom per CEMT-class.

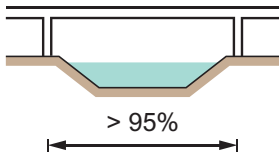
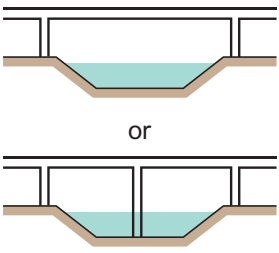
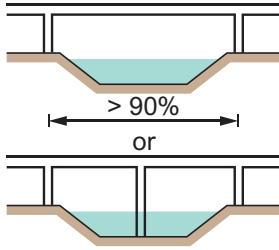
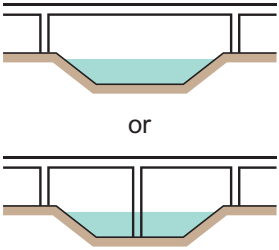
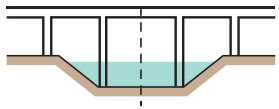
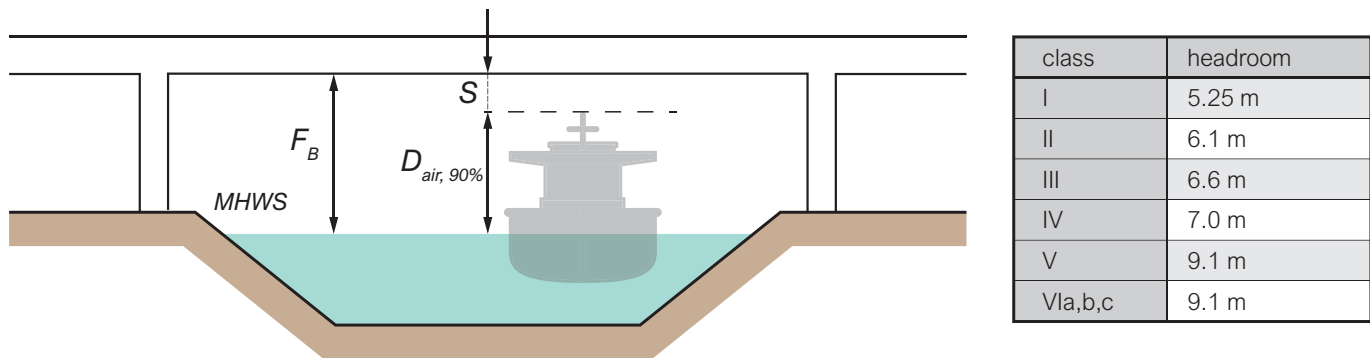

Figure 3.28: Overview of fixed bridges (reworked from RVW, 2020, by TU Delft – Ports and Waterways is licenced under CC BY-NC-SA 4.0).

The fairway manager has to indicate the actual headroom by scales mounted on the bridge or fixed in a vertical position otherwise (see Section 5.1, Figure 5.5).

Fixed bridges over fairways used exclusively for recreational purposes have to meet different requirements. RVW (2020) differentiates the required height and width dimensions by the importance of the waterway.

For further reading, for example on the passage width in more complex situations, we refer to RVW (2020).

Movable bridges Bridges over fairways of normal width for commercial traffic always have to be fixed. Movable bridge are only allowed for narrow or single-lane fairways (see Figure 3.29).

| types of movable bridge | commercial traffic | recreational traffic |
|-------------------------|------------------------------------------|------------------------------------------------------|
| normal fairway profile | <p>fixed bridge, unless open fairway</p> | <p>for M- and ZM-routes ≤ 10,000 vessels/day</p> |
| narrow fairway profile | | <p>for M- and ZM-routes ≤ 10,000 vessels/day</p> |
| single-lane profile | | non-existent |

Figure 3.29: Types of movable bridges (reworked from RVW, 2020, by TU Delft – Ports and Waterways is licenced under CC BY-NC-SA 4.0).

In order to avoid too many openings, RVW (2020) give requirements to the headroom under a movable bridge when closed (Table 3.8). The four options mentioned in this table refer to the following situations:

- *high* – applies to the normal profile; the bridge must not hinder commercial navigation; the bridge is opened only for high transports and sailing vessels with a standing mast;
- *container* – numbers are based on containers of standard height; vessels with high cube containers have to adapt to the existing headroom;
- *medium* – applies to the narrow profile; the bridge may cause some hindrance, as it needs to be opened for about 25% of the unloaded reference vessels;
- *low* – the headroom of 1.0 m applies to the single-lane profile without recreational traffic; it means that the bridge needs to be opened for almost every passing vessel; this can be avoided by taking a headroom of 5.5 m.

| vessel class | headroom option (m) | | | |
|----------------|---------------------|-----------|-----------|--------------------------------------------------------|
| | high | container | middle | low |
| I | 5.25 | 5.25 | 4.75 | 0.5m - 1.0m or height of recreational traffic |
| II | 6.1 | 5.6 | 5.6 | |
| III | 6.6 | 6.2 | 6.2 | |
| IV | 7.0 | 7.0 | 6.4 | |
| V | 9.1 | 9.1 | 7.4 | |
| Vla,b,c | 9.1 | 0.1 | not appl. | not appl. |

Table 3.8: Headroom under movable bridges when closed (reworked from [RVW, 2020](#), by TU Delft – Ports and Waterways is licenced under CC BY-NC-SA 4.0).

The passage width under the movable part of a bridge is determined by considerations of smooth and safe navigation, as well as minimal hindrance for the traffic on land and on water. [Table 3.9](#) gives a summary. In situations with strong cross-winds, additional width may be required.

| vessel class | fairway profile | | |
|----------------|--------------------------------------------------------------|-----------|-------------|
| | normal | narrow | single-lane |
| I | fixed bridge, unless it concerns an open fairway | 8.5 | 7.0 |
| II | | 10.5 | 8.5 |
| III | | 12.0 | 10.5 |
| IV | | 14.0 | 12.0 |
| Va | | 16.5 | 14.5 |
| Vb | | 19.0 | 16.5 |
| Vla,b,c | | not appl. | not appl. |

Table 3.9: Passage width (m) for commercial traffic under movable bridges (reworked from [RVW, 2020](#), by TU Delft – Ports and Waterways is licenced under CC BY-NC-SA 4.0).

In principle, movable bridges over recreational waterways are only necessary for sailing boats. In that case, the axis of the passage must coincide with the fairway axis. The headroom for recreational traffic is not regulated, but has to be considered for the specific situation at hand (also see [Table 3.8](#)).

As movable bridges are not always open, they need to be provided with waiting areas at either side. Such a waiting area is located at the starboard side of the fairway and a vessel must be able to safely moor, unmoor and manoeuvre in front of the bridge. Furthermore, ongoing traffic may not be hindered by waiting vessels.

Finally, it should be noted that the wetted cross-section on the spot of a bridge passage should be reduced as little as possible as to prevent too strong suction phenomena. It is advised to limit the reduction of the wetted profile on the spot of a bridge to maximally 15% of the preferred waterway profile. The recommended depth of the waterway should be present over the entire width between the bridge piers.

3.3.3 Guide and protection works

Fender and guide works are meant to prevent damage to vessels and bridge. Design criteria are quite similar to those for locks. Guide works may not reduce the passage width by more than 5 cm at either side. They are required if the passage width is less than the values indicated in Figure 3.30.

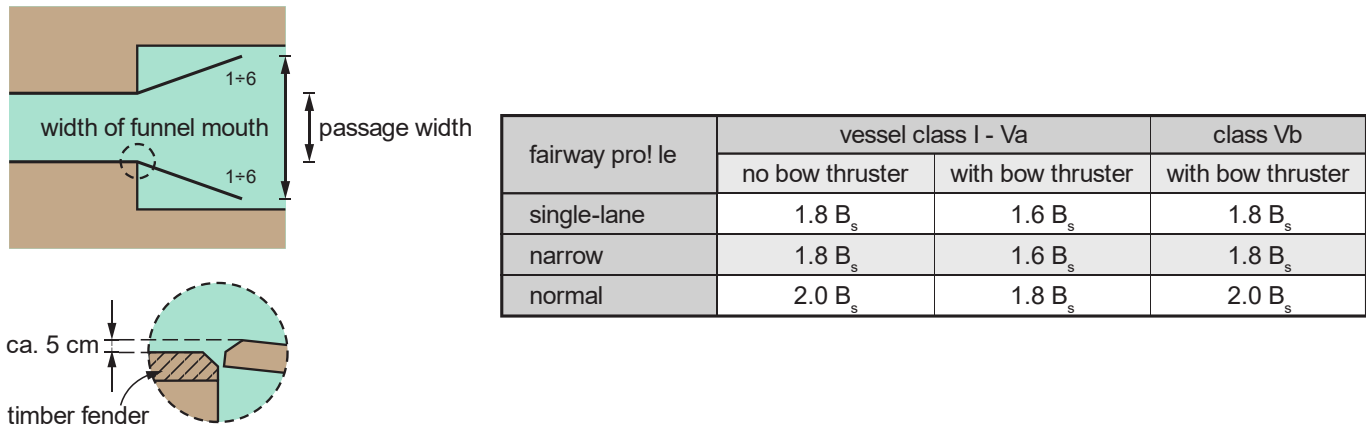

Figure 3.30: Passage width requiring guide fenders, where B_s is the width of the reference vessel (reworked from RVW, 2020, by TU Delft – Ports and Waterways is licenced under CC BY-NC-SA 4.0).

Sometimes the bridge needs a heavier protection structure. This is the case, for instance, with the City Bridge in Kampen (NL), which was estimated not to be able to withstand a collision with a rapidly moving, fully loaded large vessel. Therefore, the bridge piers are protected with concrete ramps in front (Figure 3.31).



Figure 3.31: Left: City Bridge, Kampen (NL), without concrete ramps (Kampen stadsbrug hefgedeelte by Arend041 is licenced under CC0 1.0); right: with concrete ramps (courtesy Yttje Feddes is licenced under CC BY-NC-SA 4.0).

For further reading about guide and protection works, as well as signs and signals around bridges, we refer to RVW (2020).